

Amendment-I dated 28.11.2024 to the RfP document of Appointment of Independent Engineer for “Transmission system for evacuation of power from Rajasthan REZ Ph-IV (Part-3: 6GW) [Bikaner complex]: Part-B”. Spec. No. CTUIL/IE/2024-25/58. GeM Bid: GEM/2024/B/5642878

Sl. No.	Clause Ref.	Existing provisions	Proposed Amendment
1	Clause 2.5, Section-III, Conditions of Contracts	<p>Bidder shall not have a conflict of interest that may affect the Selection Process or the Consultancy (the "Conflict of Interest"). Any bidder found to have a Conflict of Interest shall be disqualified. A bidder may be considered to have a conflict of interest with one or more parties in this bidding process, if:</p> <ul style="list-style-type: none"> (a) they have a controlling partner in common; or (b) they receive or have received any direct or indirect subsidy from any of them; or (c) they have the same legal representative for purposes of this Proposal; or (d) they have a relationship with each other, directly or through common third parties, that puts them in a position to have access to information about or influence on the Proposal of another Bidder or influence the decisions of the Employer regarding this bidding process. 	<p>Replace the existing provision with the following:</p> <p>Bidder shall not have a conflict of interest that may affect the Selection Process or the Consultancy (the "Conflict of Interest"). Any bidder found to have a Conflict of Interest shall be disqualified. A bidder may be considered to have a conflict of interest with one or more parties in this bidding process, if:</p> <ul style="list-style-type: none"> (a) they have a controlling partner(s) in common; or (b) they receive or have received any direct or indirect subsidy/financial stake from any of them; or (c) they have the same legal representative/agent for purposes of this Proposal; or (d) they have a relationship with each other, directly or through common third parties, that puts them in a position to have access to information about or influence on the Proposal of another Bidder or influence the decisions of the Employer regarding this bidding process; or (e) In case of a holding company having more than one independent manufacturing units, or more than one unit having common business ownership/management and submits bid from more than one units. Similar restrictions would apply to closely related sister companies. Bidders must proactively declare such sister/ common business/ management units in same/ similar line of business;

Amendment-I dated 28.11.2024 to the RfP document of Appointment of Independent Engineer for “Transmission system for evacuation of power from Rajasthan REZ Ph-IV (Part-3: 6GW) [Bikaner complex]: Part-B”. Spec. No. CTUIL/IE/2024-25/58. GeM Bid: GEM/2024/B/5642878

Sl. No.	Clause Ref.	Existing provisions	Proposed Amendment
2	Cl. 8 (II) (a) (ii) (l)	--	<p>Add new clause as per the following:</p> <p>(l) Attachment 12 : Declaration by the bidder for ‘Code of Integrity for Public procurement’ <i>(uploading of Scanned Copy)</i></p> <p>The bidder shall furnish in its bid the declaration about abiding by a ‘Code of Integrity for Public Procurement’ in accordance with Clause 38, Section-III-Conditions of Contracts.</p> <p>Bidder’s failure to submit the ‘Declaration for Code of Integrity for Public procurement’ along with the Bid or subsequently pursuant to Clause 20 of Section-III shall lead to outright rejection of the Bid.</p>
4	Clause 20.0, Section-III	<p>CLARIFICATION OF PROPOSALS</p> <p>During proposal evaluation, the Owner may, at its discretion, ask the Consultant for a clarification of its proposal. In case of erroneous/non-submission of</p>	<p>Replace the existing provision with the following:</p> <p>CLARIFICATION OF PROPOSALS</p> <p>During proposal evaluation, the Owner may, at its discretion, ask the Consultant for a clarification of its proposal. In case of erroneous/non-submission of</p>

Amendment-I dated 28.11.2024 to the RfP document of Appointment of Independent Engineer for “Transmission system for evacuation of power from Rajasthan REZ Ph-IV (Part-3: 6GW) [Bikaner complex]: Part-B”. Spec. No. CTUIL/IE/2024-25/58. GeM Bid: GEM/2024/B/5642878

Sl. No.	Clause Ref.	Existing provisions	Proposed Amendment
		<p>documents related to/identified in <u>Sub-Clause 8.0(II) (a)(ii) - (b), (c), (d), (e), (f), (g), (h), (i) & (j) and</u> complete annual reports of Last three financial years together with Audited statement of accounts, Online Payment acknowledgment towards Bid Security (in cases where online payment has been made prior to the deadline for submission of hardcopy part of the bids), documentary evidence with regard to registration with designated Authority of GoI under the Public Procurement Policy for MSEs required to be submitted by the Consultant as per the provisions of the RfP Documents, the Employer may give the Consultant not more than 07(Seven) <u>days'</u> notice to rectify/furnish such documents, failing which the Proposal shall be rejected. The request for clarification and the response shall be in writing, and no change in the price and CVs or substance of the Proposal shall be sought, offered or permitted.</p> <p>In case of non-submission of documents related to/identified in Attachment-11 {‘Information regarding ex-employees of Employer in Bidder’s firm’}, the Employer may give the Bidder not more than 7 days’ notice to rectify/furnish such documents, failing which Employer reserves the right to reject such bids. Employer shall be sole judge in this regard.</p>	<p>documents related to/identified in <u>Sub-Clause 8.0(II) (a)(ii) - (b), (c), (d), (e), (f), (g), (h), (i), (j), (k), (l) and</u> complete annual reports of Last three financial years together with Audited statement of accounts, Online Payment acknowledgment towards Bid Security (in cases where online payment has been made prior to the deadline for submission of hardcopy part of the bids), documentary evidence with regard to registration with designated Authority of GoI under the Public Procurement Policy for MSEs required to be submitted by the Consultant as per the provisions of the RfP Documents, the Employer may give the Consultant not more than 07(Seven) days’ notice to rectify/ furnish such documents, failing which the Proposal shall be rejected. The request for clarification and the response shall be in writing, and no change in the price and CVs or substance of the Proposal shall be sought, offered or permitted.</p> <p>In case of non-submission of documents related to/identified in Attachment-11 {‘Information regarding ex-employees of Employer in Bidder’s firm’}, the Employer may give the Bidder not more than 7 days’ notice to rectify/furnish such documents, failing which Employer reserves the right to reject such bids. Employer shall be sole judge in this regard.</p>

Amendment-I dated 28.11.2024 to the RfP document of Appointment of Independent Engineer for “Transmission system for evacuation of power from Rajasthan REZ Ph-IV (Part-3: 6GW) [Bikaner complex]: Part-B”. Spec. No. CTUIL/IE/2024-25/58. GeM Bid: GEM/2024/B/5642878

Sl. No.	Clause Ref.	Existing provisions	Proposed Amendment
5		<p>38.0 FRAUD AND CORRUPT PRACTICES</p> <p>38.1 The Bidders and their respective officers, employees, agents and advisers shall observe the highest standard of ethics during the Selection Process. Notwithstanding anything to the contrary contained in this RfP, employer shall reject a proposal without being liable in any manner whatsoever to the Bidder, if it determines that the Bidder has, directly or indirectly or through an agent, engaged in corrupt practice, fraudulent practice, coercive practice, undesirable practice or restrictive practice (collectively the “Prohibited Practices”) in the Selection Process.</p> <p>38.2 Without prejudice to the rights of Employer, if a Bidder or Consultant, as the case may be, is found by the employer to have directly or indirectly or through an agent, engaged or indulged in any corrupt practice, fraudulent practice, coercive practice, undesirable practice or restrictive practice during the Selection Process, or after the issue of the notification of Award, such bidder or Independent Engineer shall not be eligible to participate in any tender or RfP issued by Employer during a period of 2</p>	<p>Replace Clause 38.0 with the following provisions:</p> <p>38. FRAUD AND CORRUPT PRACTICES</p> <p>38.1 It is the Employer’s policy that requires the bidder to sign a declaration alongwith its bid about abiding by a ‘Code of Integrity for Public Procurement’. This policy is attached as Annexure-B to Section-III.</p> <p>38.2 In pursuance of this policy, the Employer:</p> <p>(a) will take appropriate measures in line with the above policy if it determines that the bidder recommended for award has, directly or through an agent, has violated this Code of Integrity in competing for the contract in question; and</p> <p>(b) will have the right to require that the provision be included in Bidding Documents and in contracts, requiring Bidders, suppliers, and contractors and their sub-contractors to permit the Employer to inspect their accounts and records and other documents relating to bid submission and contract performance and to have them audited by auditors appointed by the Employer.</p>

Amendment-I dated 28.11.2024 to the RfP document of Appointment of Independent Engineer for “Transmission system for evacuation of power from Rajasthan REZ Ph-IV (Part-3: 6GW) [Bikaner complex]: Part-B”. Spec. No. CTUIL/IE/2024-25/58. GeM Bid: GEM/2024/B/5642878

Sl. No.	Clause Ref.	Existing provisions	Proposed Amendment
		<p>(two) years from the date such bidder or Independent Engineer, as the case may be, is found by Employer to have directly or through an agent, engaged or indulged in any corrupt practice, fraudulent practice, coercive practice, undesirable practice or restrictive practice, as the case may be.</p> <p>38.3 For the purposes of this Section, the following terms shall have the meaning hereinafter respectively assigned to them:</p> <p>“Corrupt Practice” means offering, giving, receiving, or soliciting anything of value to influence the action of Employer official(s) in the procurement process.</p> <p>“Fraudulent Practice” means any act including suppression/ misrepresentation of facts, submissions of forged/ false documents, making false declarations etc. that knowingly or recklessly misleads, or attempts to mislead, a party to obtain a financial gain or benefit, or to avoid an obligation, or to influence procurement process to the detriment of interest of the Employer, including collusive practices among bidders (prior to or after bid submission) to establish bid prices at artificial, non-competitive levels and to</p>	

Amendment-I dated 28.11.2024 to the RfP document of Appointment of Independent Engineer for “Transmission system for evacuation of power from Rajasthan REZ Ph-IV (Part-3: 6GW) [Bikaner complex]: Part-B”. Spec. No. CTUIL/IE/2024-25/58. GeM Bid: GEM/2024/B/5642878

Sl. No.	Clause Ref.	Existing provisions	Proposed Amendment
		<p>deprive Employer of the benefits of competitive prices.</p> <p>“collusive practice” shall also include an arrangement between two or more parties designed to achieve an illegitimate purpose to the detriment of interest of Employer.</p> <p>“coercive practice” is impairing or harming, or threatening to impair or harm, directly or indirectly, any party or the property of the party to influence improperly the actions of a party;</p> <p>“Obstructive practice” means</p> <p>(a) deliberately destroying, falsifying, altering or concealing of evidence material to the investigation or making false statements to investigators in order to materially impede investigation into allegations of a corrupt, fraudulent, coercive, or collusive practice; and/ or threatening, harassing or intimidating any party to prevent it from disclosing its knowledge of matters relevant to the investigation or from pursuing the investigation,</p> <p>or</p> <p>(b) acts intended to materially impede the exercise of the contractual rights or audit or</p>	

Amendment-I dated 28.11.2024 to the RfP document of Appointment of Independent Engineer for “Transmission system for evacuation of power from Rajasthan REZ Ph-IV (Part-3: 6GW) [Bikaner complex]: Part-B”. Spec. No. CTUIL/IE/2024-25/58. GeM Bid: GEM/2024/B/5642878

Sl. No.	Clause Ref.	Existing provisions	Proposed Amendment
		<p>access to information</p> <p>In persuasions of its policy, the Employer will sanction a firm or individual, including declaring ineligible, either indefinitely or for a stated period of time, to be awarded a contract if it at any time determines that the firm has, directly or through an agent, engaged in corrupt, fraudulent, collusive, coercive or obstructive practices in competing for, or in executing, a contract.</p>	
6	Clause 2.1 (l), Letter of Proposal, Section-IV	--	<p>Add a new clause 2.1 (l), Letter of Proposal, Section-IV:</p> <p>(l) Attachment 11 : Declaration by the bidder for ‘Code of Integrity for Public procurement’ <i>(uploading of Scanned Copy)</i></p> <p>The bidder shall furnish in its bid the declaration about abiding by a ‘Code of Integrity for Public Procurement’ in accordance with Clause 38, Section-III-Conditions of Contracts.</p> <p>Bidder’s failure to submit the ‘Declaration for Code of Integrity for Public</p>

Amendment-I dated 28.11.2024 to the RfP document of Appointment of Independent Engineer for “Transmission system for evacuation of power from Rajasthan REZ Ph-IV (Part-3: 6GW) [Bikaner complex]: Part-B”. Spec. No. CTUIL/IE/2024-25/58. GeM Bid: GEM/2024/B/5642878

Sl. No.	Clause Ref.	Existing provisions	Proposed Amendment
			<p>procurement’ along with the Bid or subsequently pursuant to Clause 20, Section-III-Conditions of Contracts of Section-III shall lead to outright rejection of the Bid.</p>
7	Clause 11.8(e), Section-III, Conditions of Contracts	--	<p>Add a new provision as per the following:</p> <p>(e) In case of violation/transgression of ‘Code of Integrity for Public Procurement’ by the bidder/contractor in competing for the Contract, in accordance with Clause 38, Section-III of Conditions of Contract;</p>
8.	Clause 65.0, Section-III, Conditions of Contract	--	<p>Add a new Clause 65.0 in Section-III Conditions of Contract:</p> <p>65.0 Whistle Blower and Fraud Prevention Policy</p> <p>65.1 The Contractor along with its associate/Collaborators/Sub-contractors/sub-vendors/ consultants/ service providers shall strictly adhere to the Whistle Blower and Fraud Prevention Policy of Employer displayed on its tender website https://apps.powergrid.in/pgciltenders/u/default.aspx and https://www.powergrid.in/index.php/en/code-conductpolicies. The contractor along with their</p>

Amendment-I dated 28.11.2024 to the RfP document of Appointment of Independent Engineer for “Transmission system for evacuation of power from Rajasthan REZ Ph-IV (Part-3: 6GW) [Bikaner complex]: Part-B”. Spec. No. CTUIL/IE/2024-25/58. GeM Bid: GEM/2024/B/5642878

Sl. No.	Clause Ref.	Existing provisions	Proposed Amendment
			<p>associate/Collaborators/Sub-contractors/sub-vendors/ consultants/ service providers shall observe the highest standard of ethics and shall not indulge or allow anybody else working in their organisation to indulge in fraudulent activities during execution of the contract. The contractor shall immediately appraise the Employer about any fraud or suspected fraud as soon as it comes to their notice</p>
9.	Clause 12.0, Letter of Proposal, Section-IV	--	<p>Add a new clause 12.0 in Letter of Proposal, Section-IV of RfP Document:</p> <p>12.0 We, hereby, declare that we, along with our associate/Collaborators/Sub-contractors/sub-vendors/ consultants/ service providers shall strictly adhere to the Whistle Blower and Fraud Prevention Policy of Employer.</p> <p>We, along with our associate/Collaborators/Sub-contractors/sub-vendors/ consultants/ service providers shall observe the highest standard of ethics and shall not indulge or allow anybody else working in their organisation to indulge in fraudulent activities during execution of the contract and would immediately appraise the Employer about any fraud or suspected fraud as soon as it comes to our notice.</p>
10.	Clause 11.3, Section-III,	11.3 The proposal security shall, at the bidder’s option, be in the form of a crossed bank	11.3 The proposal security shall, at the bidder’s option, be in the form of a crossed bank draft/pay

Amendment-I dated 28.11.2024 to the RfP document of Appointment of Independent Engineer for “Transmission system for evacuation of power from Rajasthan REZ Ph-IV (Part-3: 6GW) [Bikaner complex]: Part-B”. Spec. No. CTUIL/IE/2024-25/58. GeM Bid: GEM/2024/B/5642878

Sl. No.	Clause Ref.	Existing provisions	Proposed Amendment
	Conditions of Contract	<p>draft/pay order /banker certified cheque in favour of Employer i.e. ‘Central Transmission Utility of India Limited’ payable at Gurgaon or a bank guarantee, which should be issued either:</p> <p>(a) by a Public Sector Bank located in India, or</p> <p>(b) a scheduled Indian Bank having paid up capital (net of any accumulated losses) of Rs. 1,000 Million or above (the latest annual report of the Bank should support compliance of capital adequacy ratio requirement), or</p> <p>(c) by a foreign bank or a subsidiary of a foreign bank, acceptable to the Employer, with overall international corporate rating or rating of long-term debt not less than A- (A minus) or equivalent by a reputed rating agency. Further, the Bank Guarantee should be confirmed by either (i) its corresponding bank located in India; or (ii) a Public Sector Bank located in India; or (iii) a scheduled commercial private bank located in India as per para (b) above.</p> <p>The format of the bank guarantee shall be in accordance with the form of proposal security included in the RfP Documents. proposal</p>	<p>order /banker certified cheque in favour of Employer i.e. ‘Central Transmission Utility of India Limited’ payable at Gurgaon or a bank guarantee, which should be issued either:</p> <p>(a) by a Public Sector Bank located in India, or</p> <p>(b) a scheduled Indian Bank having paid up capital (net of any accumulated losses) of Rs. 1,000 Million or above (the latest annual report of the Bank should support compliance of capital adequacy ratio requirement), or</p> <p>(c) by a foreign bank or a subsidiary of a foreign bank, acceptable to the Employer, with overall international corporate rating or rating of long-term debt not less than A- (A minus) or equivalent by a reputed rating agency. Further, the Bank Guarantee should be confirmed by either (i) its corresponding bank located in India; or (ii) a Public Sector Bank located in India; or (iii) a scheduled commercial private bank located in India as per para (b) above.</p> <p>Or the proposal security shall, at the bidder’s option, be in the form of Insurance Surety Bond from an Insurer as per the guidelines issued by Insurance Regulatory and Development Authority of India (IRDAI) as amended time to</p>

Amendment-I dated 28.11.2024 to the RfP document of Appointment of Independent Engineer for “Transmission system for evacuation of power from Rajasthan REZ Ph-IV (Part-3: 6GW) [Bikaner complex]: Part-B”. Spec. No. CTUIL/IE/2024-25/58. GeM Bid: GEM/2024/B/5642878

Sl. No.	Clause Ref.	Existing provisions	Proposed Amendment
		<p>Security shall be valid upto date specified in Special Conditions of Contract (SCC), Section-IV of RfP Document, or any other date as subsequently requested under Clause 12.2 below.</p> <p>.....</p> <p>.....</p> <p>.....</p>	<p>time.</p> <p>The format of the bank guarantee/ Insurance Surety Bond shall be in accordance with the form of proposal security/ Insurance Surety Bond included in the RfP Documents. proposal Security shall be valid upto date specified in Special Conditions of Contract (SCC), Section-IV of RfP Document, or any other date as subsequently requested under Clause 12.2 below.</p> <p>.....</p> <p>.....</p> <p>.....</p>
11.	Clause 37.1, Section-III, Conditions of Contract	<p>37.1 The successful Bidder to whom the work is awarded shall be required to furnish a Contract Performance security in favour of the Employer. The performance security shall, at the Consultant’s option, be in the form of a crossed bank draft/pay order /banker certified cheque in favour of Employer or in the Form of unconditional Bank Guarantee in proforma enclosed as <i>Annexure-A to this Conditions of Contract</i>, from a bank acceptable to the owner, within fifteen Days (15) after the date of Award of the contract as per Clause 35.0 above.</p>	<p>37.1 The successful Bidder to whom the work is awarded shall be required to furnish a Contract Performance security in favour of the Employer. The performance security shall, at the Consultant’s option, be in the form of a crossed bank draft/pay order /banker certified cheque in favour of Employer or in the Form of unconditional Bank Guarantee/ Insurance Surety Bond in proforma enclosed as <i>Annexure-A to this Conditions of Contract</i>, from a bank acceptable to the owner, within fifteen Days (15) after the date of Award of the contract as per Clause 35.0 above.</p>
12.	Clause 37.3, Section-III,	<p>37.3 During execution of contract the Consultant, after submission of Performance Security in</p>	<p>37.3 During execution of contract the Consultant, after submission of Performance Security in form</p>

Amendment-I dated 28.11.2024 to the RfP document of Appointment of Independent Engineer for “Transmission system for evacuation of power from Rajasthan REZ Ph-IV (Part-3: 6GW) [Bikaner complex]: Part-B”. Spec. No. CTUIL/IE/2024-25/58. GeM Bid: GEM/2024/B/5642878

Sl. No.	Clause Ref.	Existing provisions	Proposed Amendment
	Conditions of Contract	form of a crossed bank draft/pay order /banker certified cheque/ online payment through IMPS/NEFT, may opt to furnish the Performance Security in form of bank guarantee for the same amount and as per same terms of the Contract. On acceptance by the Employer of Performance Security submitted in the form of Bank Guarantee following receipt of confirmation from the issuing Bank, the said amount shall be refunded.	of a crossed bank draft/pay order /banker certified cheque/ online payment through IMPS/NEFT, may opt to furnish the Performance Security in form of bank guarantee/ Insurance Surety Bond for the same amount and as per same terms of the Contract. On acceptance by the Employer of Performance Security submitted in the form of Bank Guarantee following receipt of confirmation from the issuing Bank, the said amount shall be refunded.
13.			In accordance with the Sl. No. 2 above, declaration is attached herewith as “ 13_Attachment 12- Declaration by the bidder for ‘Code of Integrity for Public procurement’ ”.
14.			In accordance with the Sl. No. 5 above, the policy “Code of Integrity for Public Procurement” is attached herewith as “ Annexure-B to Section-III ”.
15.			In accordance with Sl. No. 6 & 9 above, Letter of proposal is revised and revised letter of proposal is attached herewith.
16.			In accordance with Sl. No. 10 above, Bid Security Performa is revised and revised Bid Security Performa is attached herewith.
17.			In accordance with Sl. No. 11 above, “ 05 Annexure-A to Section-III ” is revised and revised “ 05 Annexure-A to Section-III ” is attached herewith.

Package Name:
Spec. No.:

Letter of Proposal

(To be Submitted in First Envelope Bid i.e. in Technical Cover on Portal)

Proposal Ref. No.

Date:

To,

C&M

Central Transmission Utility of India Limited

(A wholly owned subsidiary of POWERGRID)

10th floor, IRCON International Tower-1, Plot No. 16

Sector-32, Gurugram – 122003, Haryana

Name of Package:

Dear Sir,

1.0 Having examined the RfP Documents, including Amendment/Addenda the receipt of which is hereby acknowledged, we the undersigned, offer to deliver services as per provisions of Terms of Reference (ToR) under the above-named package in full conformity with the said RfP Documents. In accordance with provisions of the RfP Documents, we hereby submit our Proposal, in two envelopes i.e. First Envelope & Second Envelope (to be opened subsequently).

1.1 We meet eligibility requirements and have no conflict of interest in accordance with Clause 2.5 Section-III (Conditions of Contract).

1.2 We shall render all the services under the subject assignment from within India only. No services are envisaged to be taken from sources / personnel from abroad.

2.0 Attachments to the Letter of Proposal:

Package Name:
Spec. No.:

2.1 In line with the requirement of the RfP Documents, we enclose herewith the following Attachments to this Letter of Proposal:

- (a) Attachment 1 : Bid Security or documentary evidence in support of exemption of Bid Security (*submission of Hard copy in "Original" and uploading of Scanned Copy*).
- (b) Attachment 2 : Bidder's Credentials towards Technical Evaluation Criteria (*uploading of Scanned Copy and Uploading of Scanned Copies of documentary evidence in support of Bidder's qualification*)

The documentary evidence of the Bidder's eligibility to bid shall establish to the Employer's satisfaction that the Bidder, at the time of submission of its bid, is eligible as defined in ITB Clause 2.

The documentary evidence defining (i) the constitution or legal status; (ii) The principal place of business; (iii) The place of incorporation (for bidders who are corporations); or the place of registration and the nationality of the Owners (for applicants who are partnerships or individually-owned firms); (iv) In support of meeting the Technical experience, self-certified copy of Contract/ Award Letter and Utility Certificate.

The complete annual reports together with Audited statement of accounts of the company for last three years of its own (separate) immediately preceding the date of submission of bid. The Bidder shall also furnish documentary evidence/ declaration regarding Financial re-structuring of the company, if any.

If the opening of the bids pursuant to Clause 19.0 or the Technical Evaluation pursuant to ITB Clause 26.2 is carried out after 30th September, the bidder shall be required to submit the complete annual reports together with Audited statement of accounts of the company for the immediately preceding Financial Year except in cases where the Board of the Company/ Registrar of Companies has granted extension of time for finalization of accounts, for which the bidder has to submit requisite documentary evidence. In case of Bidder's failure to submit the same along with the Bid or subsequently pursuant to Clause 20.0, the Bid shall be rejected.

- (c) Attachment 3 : Undertaking regarding unconditional acceptance of Provisions of RfP documents (*uploading of Scanned Copy*)
- (d) Attachment 4 : Information for E-payment, PF details and declaration regarding Micro/Small & Medium Enterprises (*uploading of Scanned Copy*)
- (e) Attachment 5 : Power of Attorney (*submission of Hard copy in "Original" and uploading of Scanned Copy*)

Package Name:
Spec. No.:

A power of attorney, duly notarized, indicating that the person(s) signing the Proposal has(ve) the authority to sign the Proposal and thus that the Proposal is binding upon the Bidder during full period of its validity, in accordance with Clause 12.0 below.

Further, Bidder shall furnish copy of partnership deed, in case of partnership firm, Memorandum and Articles of Association, in case of limited company, ownership certificate in case of sole or proprietorship firm.

Bidder shall furnish this PoA in its own format.

- (f) Attachment 6 : Certification by the Bidder as per DoE Order in line with Clause 2.2 (*uploading of Scanned Copy*)
- (g) Attachment 7 : Affidavit of Self certification regarding Minimum Local Content in line with PPP-MII order (*submission of Hard Copy in 'Original'*), to be submitted on a non-judicial stamp paper of Rs. 100/-.

In line with the PPP-MII order, the bidder shall submit the Affidavit of self-certification, in original, indicating the percentage of Local Content and certifying that the item offered meets the Minimum Local Content and shall give details of the location(s) at which value addition is made, as prescribed in the PPP-MII Order, on a non-judicial stamp paper of Rs. 100/-.

Further, Self-certification submitted by the bidder may be verified randomly by the committee constituted as per PPP-MII order. In case of false documents/ misrepresentation of the facts, requisite action against such bidder will be taken based on the recommendation of the committee and in line with provisions of the Integrity pact.

Bidder may note that the other directions of Nodal Ministry as identified under PPP-MII order shall also be suitably considered in regard to verification/ action of the certificate

- (h) Attachment 8 : Declaration by the Bidder regarding events encountered pursuant to Clause 2.4 (*uploading of Scanned Copy*)
- (i) Attachment 9 : Integrity Pact (*submission of Hard copy in "Original" and uploading of Scanned Copy*)

The Bidder shall complete the accompanying Integrity Pact, which shall be applicable for bidding as well as contract execution, duly signed on each page by the person signing the bid and shall be returned by the Bidder in two (2) originals alongwith the Techno - Commercial

Package Name:
Spec. No.:

Part in a separate envelope, duly superscripted with 'Integrity Pact'. The Bidder shall submit the Integrity Pact on a non-judicial stamp paper of Rs. 100/-.

- (j) Attachment 10 : KMP Declaration (*uploading of Scanned Copy*)
- (k) Attachment 11 : Information regarding Ex-employees of CTUIL/ POWERGRID in our Organization (*uploading of Scanned Copy*)
- (l) Attachment 12 : Declaration by the bidder for 'Code of Integrity for Public procurement' (*uploading of Scanned Copy*)

The bidder shall furnish in its bid the declaration about abiding by a 'Code of Integrity for Public Procurement' in accordance with Clause 38, Section-III-Conditions of Contracts.

Bidder's failure to submit the 'Declaration for Code of Integrity for Public procurement' along with the Bid or subsequently pursuant to Clause 20 of Section-III shall lead to outright rejection of the Bid

3.0 We are a Micro and Small Enterprise (MSE) registered with, a designated Authority of GoI under the Public Procurement Policy for MSEs Order, 2012, Notification dated 01/06/2020 read in conjunction with related notifications issued from time to time for such enterprises. (To be filled by MSE Company only).

4.0 We have understood the instructions and the terms and conditions mentioned in the enquiry furnished by you and have thoroughly examined the terms and conditions laid down by you in the RfP documents for Engagement of consultant and are fully aware of the nature of consultancy services required.

4.1 We declare that as specified in Clause 9.0 of Section-III: Conditions of Contracts of RfP Documents, prices quoted by us shall be Firm & Fixed and shall not be subject to any adjustment during course of the Contract.

5.0 We declare that we are making the offer on a single source responsibility basis.

6.0 Our Proposal shall remain valid for acceptance for a period of 180 (One Hundred and Eighty) days from Bid submission end date of the First Envelope Proposal.

7.0 We have not made any deviations from the requirement of the RfP document and we have also not made any tampering or changes in the RfP documents on which the Proposal is being submitted and if any tampering or changes are detected at any stage, we understand the Proposal will invite summary rejection /the contract will be liable to be terminated, even if Award has been issued.

Package Name:
Spec. No.:

- 8.0 We understand that you are not bound to accept the lowest or any Proposal you may receive.
- 9.0 We are aware that the Price Schedule do not generally give a full description of the Work to be performed and we shall be deemed to have read the Terms of Reference and other sections of the RfP Documents to ascertain the full scope of Work while filling-in the rates and prices in Second Envelope.
- 10.0 We declare that prices quoted by us in second envelope includes all charges including GST. However, we understand that the GST shall be paid as per GeM terms & Conditions. We further agree that the entered prices shall be deemed to cover for the full scope as aforesaid, including overheads and profits.
- 11.0 We hereby declare that only the company, persons of firms interested in this proposal as principal or principals are named herein and that no other company person or firm other than the one mentioned herein have any interest in this proposal or in the contract to be entered into, if are awarded this contract, and that this proposal is made without any connection with any other persons, firm or party, likewise submitting a proposal and that this proposal in all respect for and in good faith without collusion or fraud.
- 12.0 We, hereby, declare that we, along with our associate/Collaborators/Sub-contractors/sub-vendors/ consultants/ service providers shall strictly adhere to the Whistle Blower and Fraud Prevention Policy of Employer.
- We, along with our associate/Collaborators/Sub-contractors/sub-vendors/ consultants/ service providers shall observe the highest standard of ethics and shall not indulge or allow anybody else working in their organisation to indulge in fraudulent activities during execution of the contract and would immediately appraise the Employer about any fraud or suspected fraud as soon as it comes to our notice.

Date :

Printed Name :

Place :

Designation :

**PROPOSAL SECURITY FORM
(for the bank Guarantee)**

((To be stamped in accordance with Stamp Act, the Non-Judicial Stamp Paper should be in the name of the issuing Bank. For the purpose of verification/confirmation of this Bank Guarantee by the Employer, the Bank shall indicate 2 official email ids of the authorized signatories from Issuing Branch and also of the designated higher office (Corporate Office, Zonal Office etc) in the covering letter of the Bank forwarding the Bank Guarantee.))

Bank Guarantee No.:
Date:

To: *(insert Name and Address of Employer)*

WHEREAS M/s. *(Insert name of Bidder)*..... having its Registered/Head Office at *(Insert address of the Bidder)* (Hereinafter called "the Bidder" **which expression shall include its successors, administrators, executors and assigns**) has submitted its Proposal for the performance of the Contract for *(Enter Package Name)*, under **Specification No.:** (Hereinafter called "the Bid")

KNOW ALL PERSONS by these present that WE *(insert name & address of the issuing bank)* having its Registered/Head Office at*(insert address of registered office of the bank)*..... (hereinafter called "the Bank" **which expression shall include its successors, administrators, executors and assigns**), are bound unto Central Transmission Utility of India Limited (hereinafter called "the Employer") in the sum of*(insert amount of Bid Security in figures & words)*..... for which payment well and truly to be made to the said Employer, the Bank binds itself, its successors and assigns by these presents.

Sealed with the Common Seal of the said Bank this day of 20....

THE CONDITIONS of this obligation are:

- (1) If the Bidder withdraws its Proposal during the period of proposal validity specified by the Bidder in the Bid Form; or
- (2) In case the Bidder does not withdraw the deviations proposed by him, if any, at the cost of withdrawal stated by him in the bid; or
- (3) If a Bidder does not accept the corrections to arithmetical errors identified during preliminary evaluation of his proposal pursuant to Clause 31.0 of Section-III, Conditions of Contract; or
- (4) In the case of a successful Bidder, if the Bidder fails within the specified time limit

- (i) to sign the Contract Agreement, in accordance with Clause 36.0 of Section-III (Conditions of Contract), or
 - (ii) to furnish the required performance security(ies), in accordance with Clause 37.0 of Section-III (Conditions of Contract) and/or to keep the proposal security valid as per the requirement of Clause 11.3 of Section-III (Conditions of Contract).
- or

(6) In any other case specifically provided for in RfP Document.

WE undertake to pay to the Employer up to the above amount upon receipt of its first written demand, without the Employer having to substantiate its demand, provided that in its demand the Employer will note that the amount claimed by it is due to it, owing to the occurrence of any of the above-named CONDITIONS or their combination, and specifying the occurred condition or conditions.

This guarantee will remain in full force up to and including (*insert date in line with Clause 11.3 of Section-IV, Conditions of Contract*)....., and any demand in respect thereof must reach the Bank not later than the above date.

Notwithstanding anything contained herein:

- 1. Our liability under this Bank Guarantee shall not exceed _____ (*value in figures*)_____ [*value in words*]_____.
- 2. This Bank Guarantee shall be valid upto _____(*validity date*)_____.
- 3. We are liable to pay the guaranteed amount or any part thereof under this Bank Guarantee only & only if we receive a written claim or demand on or before _____ (*validity date*) _____

For and on behalf of the Bank

[*Signature of the authorised signatory(ies)*]

Signature_____

Name_____

Designation_____

POA Number_____

Contact Number(s): Tel._____ Mobile_____

Fax Number_____

email _____

Common Seal of the Bank_____

Witness:

Signature_____

Name_____

Address_____

Contact Number(s): Tel._____ Mobile_____

email _____

Note:

1. The Bank Guarantee should be in accordance with the proforma as provided. However, in case the issuing bank insists for additional paragraph regarding applicability of ICC publication No: 758, the following may be added at the end of the proforma of the Bank Guarantee [*i.e., end paragraph of the Bank Guarantee preceding the signature(s) of the issuing authority(ies) of the Bank Guarantee*]:

“This Guarantee is subject to Uniform Rules for Demand Guarantee, ICC publication No. 758.”

2. **At the time of issuance of the Bank Guarantee (including its extensions) through SFMS facility, the issuing bank will input the IFSC code of Beneficiary Bank as mentioned at *Clause 11.4 of Section-III, Conditions of Contract* in their Trade Finance Portal.**

Additional paragraph regarding issuance of the Bank Guarantee through SFMS Platform (if applicable), the following should be added at the end of the proforma of the Bank Guarantee [*i.e., end paragraph of the Bank Guarantee preceding the signature(s) of the issuing authority(ies) of the Bank Guarantee*]:

“This Guarantee has been issued using SFMS Platform and the requisite communication in this regard has been forwarded to the Beneficiary Bank.”

**PROPOSAL SECURITY FORM
(For Insurance Surety Bond)**

(To be stamped in accordance with Stamp Act of India)

Insurance Surety Bond No.:

Date:

To: (insert Name and Address of Employer)

WHEREAS M/s. (Insert name of Bidder)..... having its Registered/Head Office at (Insert address of the Bidder) (Hereinafter called "the Bidder" which expression shall include its successors, administrators, executors and assigns) has submitted its Bid for the performance of the Contract for '.....', under Specification No.: (Hereinafter called "the Bid")

KNOW ALL PERSONS by these present that WE (*insert name & address of the Insurer*) having its Registered/Head Office at(*insert address of registered office of the Insurer*)..... (hereinafter called "**the Insurer**" which expression shall include its successors, administrators, executors and assigns), are bound unto(*insert name of Employer*)..... (hereinafter called "the Employer") in the sum of(*insert amount of Bid Security in figures & words*)..... for which payment well and truly to be made to the said Employer, the **Insurer** binds itself, its successors and assigns by these presents.

Sealed with the Common Seal of the said **Insurer** this day of 20....

THE CONDITIONS of this obligation are:

- (1) If the Bidder withdraws its Proposal during the period of proposal validity specified by the Bidder in the Bid Form; or
- (2) In case the Bidder does not withdraw the deviations proposed by him, if any, at the cost of withdrawal stated by him in the bid; or
- (3) If a Bidder does not accept the corrections to arithmetical errors identified during preliminary evaluation of his proposal pursuant to Clause 31.0 of Section-III, Conditions of Contract; or
- (4) In the case of a successful Bidder, if the Bidder fails within the specified time limit
 - (i) to sign the Contract Agreement, in accordance with Clause 36.0 of Section-III (Conditions of Contract), or

(ii) to furnish the required performance security(ies), in accordance with Clause 37.0 of Section-III (Conditions of Contract) and/or to keep the proposal security valid as per the requirement of Clause 11.3 of Section-III (Conditions of Contract).

or

(6) In any other case specifically provided for in RfP Document.

WE undertake to pay to the Employer up to the above amount upon receipt of its first written demand, without the Employer having to substantiate its demand, provided that in its demand the Employer will note that the amount claimed by it is due to it, owing to the occurrence of any of the above-named CONDITIONS or their combination, and specifying the occurred condition or conditions.

This guarantee will remain in full force up to and including (*insert date in line with Clause 11.3 of Section-IV, Conditions of Contract*), and any demand in respect thereof must reach the **Insurer** not later than the above date.

Notwithstanding anything contained herein:

1. Our liability under this **Insurance Surety Bond** shall not exceed _____ (*value in figures*)_____ [*value in words*]_____].
2. This **Insurance Surety Bond** shall be valid upto _____(*validity date*)_____.
3. We are liable to pay the guaranteed amount or any part thereof under this **Insurance Surety Bond** only & only if we receive a written claim or demand on or before _____ (*validity date*) _____

For and on behalf of the **Insurer**

[*Signature of the authorised signatory(ies)*]

Signature_____

Name_____

Designation_____

Contact Number(s): Tel._____ Mobile_____

Fax Number_____

email _____

Common Seal _____

Witness:

Signature_____

Name_____

Address_____

Contact Number(s): Tel._____Mobile_____

email_____

Note:

- 1. The Insurance Surety Bond shall be from an Insurer as per guidelines issued by Insurance Regulatory and Development Authority of India (IRDAI) as amended from time to time.**
- 2. The Employer shall be the Creditor, the Bidder shall be the Principal debtor and the Insurance company/Insurer shall be the Surety in respect of the Insurance Surety Bond to be issued by the Insurer.**
- 3. The Insurance Surety Bond should be on Non-Judicial stamp paper/e-stamp paper of appropriate value as per Stamp Act prevailing in the state(s) where the Insurance Surety Bond is submitted or is to be acted upon or the rate prevailing in State where the Insurance Surety Bond is executed, whichever is higher. The Stamp Paper/e-stamp paper shall be purchased in the name of Bidder/Insurer issuing the Insurance Surety Bond.**
- 4. While getting the Insurance Surety Bond issued, Bidders are required to ensure compliance to the points mentioned in Form of Insurance Surety Bond.**

Annexure-A to Section-III: Conditions of Contract

ANENXURE-A

**1. PROFORMA BANK GUARANTEE FOR CONTRACT PERFORMANCE
(for the Bank Guarantee)**

(To be stamped in accordance with Stamp Act)

The non-judicial stamp paper should be in the name of issuing bank

Bank Guarantee No.

Date.....

NOA/Contract No.....

.....[Name of Independent Engineer].....

To: [Name and address of the Employer]

Dear Ladies and/or Gentlemen,

We refer to the Contract ("the Contract")

Generated through GeM portal on(insert date of the GeM Contract Order).....
between you and M/s (Name of Independent Engineer),

(or)

vide GeM Contract Order Generated through GeM portal on (insert date of the
GeM Contract Order)....by you to M/s (Name of Independent
Engineer),

having its Principal place of business at(Address of Independent Engineer)
..... and Registered Office at(Registered address of Independent
Engineer) ("**the Independent
Engineer**") concerning (Indicate brief scope of work)
for the complete execution of the (insert name of Package alongwith name of the
Project)..... [Applicable for Bank Guarantees issued by Consultant for those Contracts
awarded to them]

By this letter we, the undersigned,(insert name & address of the issuing bank)
....., a Bank (which expression shall include its successors, administrators, executors
and assigns) organized under the laws of and having its
Registered/Head Office at(insert address of registered office of the bank)..... do
hereby irrevocably guarantee payment to you up to i.e., five
percent (5%) of the Contract Price until ninety (90) days beyond scheduled date of final
acceptance of work i.e., upto and inclusive of (dd/mm/yy).

Annexure-A to Section-III: Conditions of Contract

We undertake to make payment under this Letter of Guarantee upon receipt by us of your first written demand signed by your duly authorized officer declaring the *Independent Engineer* to be in default under the Contract and without cavil or argument any sum or sums within the above-named limits, without your need to prove or show grounds or reasons for your demand and without the right of the *Independent Engineer* to dispute or question such demand.

Our liability under this Letter of Guarantee shall be to pay to you whichever is the lesser of the sum so requested or the amount then guaranteed hereunder in respect of any demand duly made hereunder prior to expiry of the Letter of Guarantee, without being entitled to inquire whether or not this payment is lawfully demanded.

This letter of Guarantee shall remain in full force and shall be valid from the date of issue until ninety (90) days beyond scheduled date of final acceptance of work i.e. upto and inclusive of (dd/mm/yy) and shall be extended from time to time for such period (not exceeding one year), as may be desired by M/s. on whose behalf this Letter of Guarantee has been given.

Except for the documents herein specified, no other documents or other action shall be required, notwithstanding any applicable law or regulation.

Our liability under this Letter of Guarantee shall become null and void immediately upon its expiry, whether it is returned or not, and no claim may be made hereunder after such expiry or after the aggregate of the sums paid by us to you shall equal the sums guaranteed hereunder, whichever is the earlier.

All notices to be given under shall be given by registered (airmail) posts to the addressee at the address herein set out or as otherwise advised by and between the parties hereto.

We hereby agree that any part of the Contract may be amended, renewed, extended, modified, compromised, released or discharged by mutual agreement between you and the *Independent Engineer*, and this security may be exchanged or surrendered without in any way impairing or affecting our liabilities hereunder without notices to us and without the necessity for any additional endorsement, consent or guarantee by us, provided, however, that the sum guaranteed shall not be increased or decreased.

No action, event or condition which by any applicable law should operate to discharge us from liability hereunder shall have any effect and we hereby waive any right we may have to apply such law so that in all respects our liability hereunder shall be irrevocable and, except as stated herein, unconditional in all respects.

“Notwithstanding anything contained herein:

Annexure-A to Section-III: Conditions of Contract

1. Our liability under this Bank Guarantee shall not exceed _____ (value in figures)_____ [_____ (value in words)_____].
2. This Bank Guarantee shall be valid upto _____(validity date)_____.
3. We are liable to pay the guaranteed amount or any part thereof under this Bank Guarantee only & only if we receive a written claim or demand on or before _____ (validity date) _____."

For and on behalf of the Bank

[Signature of the authorised signatory(ies)]

Signature_____

Name_____

Designation_____

POA Number_____

Contact Number(s): Tel._____ Mobile_____

Fax Number_____

email _____

Common Seal of the Bank_____

Witness:

Signature_____

Name_____

Address_____

Contact Number(s): Tel._____ Mobile_____

email _____

Note :

Annexure-A to Section-III: Conditions of Contract

1. For the purpose of executing the Bank Guarantee, the non-judicial stamp papers of appropriate value shall be purchased in the name of Bank who issues the 'Bank Guarantee'.
2. The Bank Guarantee shall be signed on all the pages by the Bank Authorities indicating their POA nos. and should invariably be witnessed.
3. The Bank Guarantee should be in accordance with the proforma as provided. However, in case the issuing bank insists for additional paragraph regarding applicability of ICC Publication No. 758, the following may be added at the end of the proforma of the Bank Guarantee [*i.e., end paragraph of the Bank Guarantee preceding the signature(s) of the issuing authority(ies) of the Bank Guarantee*]:

Quote

This guarantee is subjected to uniform Rules for Demand Guarantee, ICC publication No. 758.

Unquote

4. **At the time of issuance of the Bank Guarantee (including its extensions) through SFMS facility, the issuing bank will input the IFSC code of Beneficiary Bank as mentioned at clause 12.1.4 Section-III, conditions of contract in their Trade Finance Portal.**
Additional paragraph regarding issuance of the Bank Guarantee through SFMS Platform (if applicable), the following should be added at the end of the proforma of the Bank Guarantee [*i.e., end paragraph of the Bank Guarantee preceding the signature(s) of the issuing authority(ies) of the Bank Guarantee*]:

"This Guarantee has been issued using SFMS Platform and the requisite communication in this regard has been forwarded to the Beneficiary Bank."

2. PERFORMANCE SECURITY FORM

(For Insurance Surety Bond)

Annexure-A to Section-III: Conditions of Contract

(To be stamped in accordance with Stamp Act of India)

Insurance Surety Bond No.:

Date:

NOA/Contract No.....

.....[Name of Contract].....

To: [Name and address of the Owner]

Dear Ladies and/or Gentlemen,

We refer to the Contract ("the Contract")

vide notification of award issued on (insert date of the notification of award)
...by you to M/s (Name of Contractor),

(or)

signed on(insert date of the Contract)..... between you and M/s
(Name of Contractor),

having its Principal place of business at(Address of Contractor) and Registered Office at(Registered address of Contractor) ("the Contractor") concerning (Indicate brief scope of work) for the complete execution of the (insert name of Package alongwith name of the Project) [Applicable for **Insurance Surety Bond** issued by Contractor/Associate for those Contracts awarded to them]

Or

We refer to the Contract

signed on(insert date of the Contract)..... between you and M/s
(Name of Contractor),

(or)

vide notification of award issued on(insert date of the notification of award)..... by you to M/s (Name of Contractor)

having its Principal place of business at(Address of Contractor) and Registered Office at(Registered address of Contractor) ("the Contractor") and the Contract ("the Contract") signed on(insert date of the Contract)..... between you and M/s (Name of Associate), having its Principal place of business at(Address of Associate) and Registered Office at

Annexure-A to Section-III: Conditions of Contract

.....(Registered address of Associate), the Associate of the Contractor for executing the Facilities concerning (Indicate brief scope of work) for the complete execution of the (insert name of Package alongwith name of the Project)..... [Applicable for **Insurance Surety Bond** to be issued by Contractor against those Contracts awarded to their Associate]

By this letter we, the undersigned,(insert name & address of the issuing **Insurer**), a **Insurer** (which expression shall include its successors, administrators, executors and assigns) organized under the laws of and having its Registered/Head Office at(insert address of registered office of the **Insurer**) do hereby irrevocably guarantee payment to you up to i.e., five percent (5%) of the Contract Price until ninety (90) days beyond the Defect Liability Period i.e., upto and inclusive of (dd/mm/yy).

We undertake to make payment under this **Insurance Surety Bond** upon receipt by us of your first written demand signed by your duly authorized officer declaring the Contractor to be in default under the Contract and without cavil or argument any sum or sums within the above named limits, without your need to prove or show grounds or reasons for your demand and without the right of the Contractor to dispute or question such demand.

Our liability under this **Insurance Surety Bond** shall be to pay to you whichever is the lesser of the sum so requested or the amount then guaranteed hereunder in respect of any demand duly made hereunder prior to expiry of the Letter of Guarantee, without being entitled to inquire whether or not this payment is lawfully demanded.

This **Insurance Surety Bond** shall remain in full force and shall be valid from the date of issue until ninety (90) days beyond the Defect Liability Period of the Facilities i.e. upto and inclusive of (dd/mm/yy) and shall be extended from time to time for such period (not exceeding one year), as may be desired by M/s. on whose behalf this Letter of Guarantee has been given.

Except for the documents herein specified, no other documents or other action shall be required, notwithstanding any applicable law or regulation.

Our liability under this **Insurance Surety Bond** shall become null and void immediately upon its expiry, whether it is returned or not, and no claim may be made hereunder after such expiry or after the aggregate of the sums paid by us to you shall equal the sums guaranteed hereunder, whichever is the earlier.

All notices to be given under shall be given by registered (airmail) posts to the addressee at the address herein set out or as otherwise advised by and between the parties hereto.

We hereby agree that any part of the Contract may be amended, renewed, extended, modified, compromised, released or discharged by mutual agreement between you and the Contractor, and this security may be exchanged or surrendered without in any way

Annexure-A to Section-III: Conditions of Contract

impairing or affecting our liabilities hereunder without notices to us and without the necessity for any additional endorsement, consent or guarantee by us, provided, however, that the sum guaranteed shall not be increased or decreased.

No action, event or condition which by any applicable law should operate to discharge us from liability hereunder shall have any effect and we hereby waive any right we may have to apply such law so that in all respects our liability hereunder shall be irrevocable and, except as stated herein, unconditional in all respects.

Notwithstanding anything contained herein:

1. Our liability under this **Insurance Surety Bond** shall not exceed _____ (*value in figures*) _____ [*value in words*] _____].
2. This **Insurance Surety Bond** shall be valid upto _____ (*validity date*) _____.
3. We are liable to pay the guaranteed amount or any part thereof under this **Insurance Surety Bond** only & only if we receive a written claim or demand on or before _____ (*validity date*) _____.

For and on behalf of the **Insurer**

[*Signature of the authorised signatory(ies)*]

Signature _____

Name _____

Designation _____

Contact Number(s): Tel. _____ Mobile _____

Fax Number _____

email _____

Common Seal of the Insurer _____

Witness:

Signature _____

Name _____

Address _____

Contact Number(s): Tel. _____ Mobile _____

email _____

Annexure-A to Section-III: Conditions of Contract

Note:

1. The Insurance Surety Bond should be on Non-Judicial stamp paper/e-stamp paper of appropriate value as per Stamp Act prevailing in the state(s) where the Insurance Surety Bond is submitted or is to be acted upon or the rate prevailing in State where the Insurance Surety Bond is executed, whichever is higher. The Stamp Paper/e-stamp paper shall be purchased in the name of Bidder/Insurer issuing the Insurance Surety Bond.
2. The Insurance Surety Bond shall be signed on all the pages by the Insurer Authorities and should invariably be witnessed.
3. The Insurance Surety Bond shall be from an Insurer as per guidelines issued by Insurance Regulatory and Development Authority of India (IRDAI) as amended from time to time.
4. The Employer shall be the Creditor, the Bidder shall be the Principal debtor and the Insurance company/Insurer shall be the Surety in respect of the Insurance Surety Bond to be issued by the Insurer.
5. While getting the Insurance Surety Bond issued, Contractors/ Suppliers are required to ensure compliance to the points mentioned in Form of Insurance Surety Bond.

1.0 Code of Integrity for Public Procurement

1.1 Employer as well as bidders, suppliers, contractors and consultants should observe the highest standard of ethics and should not indulge in the following prohibited practices, either directly or indirectly, at any stage during the procurement process or during execution of resultant contracts:

- i) “Corrupt practice”: making offers, solicitation or acceptance of bribe, rewards or gifts or any material benefit, in exchange for an unfair advantage in the procurement process or to otherwise influence the procurement process or contract execution;
- ii) “Fraudulent practice”: any omission or misrepresentation that may mislead or attempt to mislead so that financial or other benefits may be obtained or an obligation avoided. This includes making false declaration or providing false information for participation in a tender process or to secure a contract or in execution of the contract;
- iii) “Anti-competitive practice”: any collusion, bid rigging or anti-competitive arrangement, or any other practice coming under the purview of The Competition Act, 2002, between two or more bidders, with or without the knowledge of the Employer, that may impair the transparency, fairness and the progress of the procurement process or to establish bid prices at artificial, noncompetitive levels;
- iv) “Coercive practice”: harming or threatening to harm, persons or their property to influence their participation in the procurement process or affect the execution of a contract;
- v) “Conflict of interest”: any personal, financial, or business relationship between the bidder and any personnel of the procuring entity who are directly or indirectly related to the procurement or execution process of the contract, which can affect the decision of the procuring entity directly or indirectly.
- vi) “Undue Advantage”: improper use of information obtained by the bidder from the procuring entity with an intent to gain an unfair advantage in the procurement process or for personal gain. This also includes if the bidder (or his allied firm) provided services for the need assessment/ procurement planning of the tender process in which it is participating;
- vii) “Obstructive practice”: materially impede the Employer’s investigation into allegations of one or more of the above mentioned prohibited practices either by deliberately destroying, falsifying, altering; or by concealing of evidence material to the investigation; or by making false statements to investigators and/or by threatening, harassing or intimidating any party to prevent it from disclosing its knowledge of matters relevant to the investigation or from pursuing the investigation; or by impeding the Employer’s rights of audit or access to information.

1.2 Obligations for Proactive Disclosures

- i) POWERGRID as well as bidders, suppliers, contractors and consultants, are obliged under Code of Integrity for Public Procurement to suo-moto proactively declare any conflicts of interest (coming under the definition mentioned above – pre-existing or as and as soon as these arise at any stage) in any procurement process or execution of contract. Failure to do so would amount to violation of this code of integrity; and
- ii) Any bidder must declare, whether asked or not in a bid document, any previous transgressions of such a code of integrity with any entity in any country during the last three years or of being debarred by any other procuring entity. Failure to do so would amount to violation of this code of integrity.
- iii) To encourage voluntary disclosures, such declarations would not mean automatic disqualification for the bidder making such declarations. The declared conflict of interest may be evaluated and mitigation steps, if possible, may be taken by POWERGRID. Similarly voluntary reporting of previous transgressions of Code of Integrity elsewhere may be evaluated and barring cases of various grades of debarment, an alert watch may be kept on the bidder's actions in the tender and subsequent contract.

1.3 Punitive Provisions: Without prejudice to and in addition to the rights of POWERGRID to other penal provisions as per the Bidding Documents or Contract, if POWERGRID comes to a conclusion that a (prospective) bidder/supplier, directly or through an agent, has violated this code of integrity in competing for the contract or in executing a contract, POWERGRID may take appropriate measures including one or more of the following:

- i) if the bid(s) is under consideration in any procurement
 - a) Forfeiture or encashment of Bid Security
 - b) calling off of any pre-contract negotiations, and;
 - c) rejection and exclusion of the bidder from the procurement process
- ii) if a contract has already been awarded
 - a) Cancellation/termination of the contract in question;
 - b) Forfeiture or encashment of Contract Performance Guarantee (CPG) of the contract in question;
- iii) Provisions in addition to above:
 - a) Removal from the list of registered suppliers and banning/debarment of the bidder/contractor from participation in future procurements in line with POWERGRID's policy for "*Black-Listing of Firms / Banning of Business*".

- b) In case of anti-competitive practices, information for further processing may be filed with the Competition Commission of India;
- c) Initiation of suitable disciplinary or criminal proceedings against any individual or staff found responsible.

1.4 In pursuance to this policy, the Employer will have the right to require that the provision be included in Bidding Documents and in contracts, requiring Bidders, suppliers, and contractors and their sub-contractors to permit the Employer to inspect their accounts and records and other documents relating to bid submission and contract performance under this project only and to have them audited by auditors appointed by the Employer.

-----End of Appendix-II of SCC-----

(Declaration by the bidder for 'Code of Integrity for Public procurement')

Bidder's Name and Address:

To:

Name :

Address :

C&M

Central Transmission Utility of India Limited

(A wholly owned subsidiary of POWERGRID)

10th floor, IRCON International Tower-1, Plot No. 16

Sector-32, Gurugram - 122003, Haryana

Dear Sir,

1.0 We have read the provisions of the bidding documents regarding abiding by the 'Code of Integrity for Public Procurement'. Accordingly, we hereby declare that we shall abide by the 'Code of Integrity for Public Procurement' as mentioned under Clause 38, Section-III, Conditions of Contracts of the Bidding Documents.

The details of any previous transgressions of the code of integrity with any entity in any country during the last three years or of being debarred by any other Procuring Entity are as under:

(a)

(b)

(c)

2.0 We also accept that in case of violation/transgression of this code by us in competing for or in executing the Contract, Employer has the right to take punitive measures as per the provisions of the Bidding Documents and/or CTUIL/POWERGRID's policy and procedure.

Date:

Name and Signature:

Place:

Designation:

सेंट्रल ट्रांसमिशन यूटिलिटी ऑफ इंडिया लिमिटेड
CENTRAL TRANSMISSION UTILITY OF INDIA LIMITED
(Wholly Owned Subsidiary of Power Grid Corporation of India Limited)
(A Government of India Enterprise)

REQUEST FOR PROPOSAL (RfP)

(Section - I: Request for Proposal)

for

Appointment of Independent Engineer for "Transmission system for evacuation of power from Rajasthan REZ Ph-IV (Part-3: 6GW) [Bikaner complex]: Part-B"

(Spec. No. CTUIL/IE/2024-25/58)

(This document is meant for exclusive purpose of bidding against this specification only and shall not be transferred, reproduced or otherwise used for purpose other than that for which it is specifically issued)

REQUEST FOR PROPOSALS (RfP)

(Domestic Competitive Bidding)

(SINGLE STAGE TWO ENVELOPE BIDDING)

DATE : 25.11.2024

FUNDING : DOMESTIC

1.0 This Request for Proposal (RfP) for the subject package have been published on [25.11.2024](#) on CTUIL's website, GeM (Government e-marketplace) portal (link provided at para 9.0 below) and on Government of India's Central Public Procurement Portal (<https://eprocure.gov.in>). Any Corrigendum and/or amendments, etc. shall also be published only on the above website/portals.

2.0 Central Transmission Utility of India Limited (CTUIL), (wholly Owned Subsidiary of Power Grid Corporation of India Limited) a Government of India Enterprise incorporated under the Companies Act, 2013, having its Registered Office at "Saudamini", Plot No.-2, Sector 29, Gurgaon-122001, Haryana (hereinafter referred to as 'CTUIL'/'Owner'/'Employer') has decided to engage an **Appointment of Independent Engineer for "Transmission system for evacuation of power from Rajasthan REZ Ph-IV (Part-3: 6GW) [Bikaner complex]: Part-B"**.

3.0 **Scope of work:**

3.1 The detailed scope of work and deliverables covered under the subject package **Appointment of Independent Engineer for "Transmission system for evacuation of power from Rajasthan REZ Ph-IV (Part-3: 6GW) [Bikaner complex]: Part-B"** are given in Section - II: Terms of Reference (ToR) of the Bidding Documents for following Transmission Scheme:

Scope of Work of the Transmission Scheme:

Sl. No.	Scope of the Transmission Scheme	Scheduled COD in months from Effective date
1	Establishment of 765/400kV, 6x1500 MVA S/s at suitable location near Siwani (Distt. Bhiwani) along with 2x240 MVAr (765kV) Bus Reactor & 2x125 MVAr (420kV) Bus Reactor Siwani S/s- AIS <ul style="list-style-type: none">• 765/400 kV 1500 MVA ICTs- 6 Nos. (19x500 MVA including one spare unit)	11/11/2026 (24 Months)

	<ul style="list-style-type: none"> • 765 kV ICT bays-6 Nos. • 400 kV ICT bays- 6 Nos. • 765 kV line bays – 2 Nos. (for 765kV interconnection with Bikaner-IV PS) • 400 kV line bays – 4 Nos. (for 400kV interconnections) • 240 MVA_r Bus Reactor-2 Nos. (7x80 MVA_r, including one spare unit) • 765 kV Bus reactor bays-2 Nos. • 125 MVA_r Bus Reactor-2 Nos. • 400 kV Bus reactor bays- 2 Nos. • 400kV Sectionalizer bay: 1 set • 400kV bays: 2 Nos. (for STATCOM) <p>Future provisions at Siwani S/s: Space for</p> <ul style="list-style-type: none"> • <i>765 kV line bays along with switchable line reactors – 8Nos.</i> • <i>765 kV Bus Reactor along with bay: 1 No.</i> • <i>400 kV line bays along with switchable line reactor –8 Nos.</i> • <i>400 kV Bus Reactor along with bays: 1 No.</i> • <i>400 kV Sectionalizer bay: 1 set</i> 	
2	<p>Bikaner-IV PS – Siwani 765 kV D/C (2nd) line along with 240 MVA_r switchable line reactor for each circuit at each end Line Length -237 kms (Approx.)</p> <ul style="list-style-type: none"> • 765 kV, 240 MVA_r switchable line reactors at Bikaner-IV PS end– 2 Nos. • 765 kV, 240 MVA_r switchable line reactors at Siwani S/s end– 2 Nos. • Switching equipment for 765kV, 240 MVA_r switchable line reactors at Bikaner-IV PS end – 2 Nos. • Switching equipment for 765kV, 240 MVA_r switchable line reactors at Siwani S/s end – 2 Nos. 	
3	<p>STATCOM (2x±300MVA_r) along with MSC (4x125 MVA_r) & MSR (2x125 MVA_r) at Siwani S/s</p>	
4	<p>Siwani – Sonipat (PG) 400 kV D/C line (Quad) along with 63 MVA_r switchable line</p>	

	reactor for each circuit at Siwani S/s end Line Length -136 kms (Approx.) • 420 kV, 63 MVAR switchable line reactors at Siwani S/s end– 2 Nos. • Switching equipment for 420kV, 63 MVAR switchable line reactors at Siwani S/s end – 2 Nos.	
5	Siwani – Jind (PG) 400 kV D/C line (Quad) Line Length -94 kms (Approx.)	
6	2 Nos. 400 kV line bays each at Jind (PG) & Sonipat (PG) S/s • 400 kV line bays at Jind (PG) S/s – 2 Nos. • 400 kV line bays at Sonipat (PG) S/s – 2 Nos.	
7	2 Nos. 765 kV line bays at Bikaner-IV PS • 765 kV line bays at Bikaner-IV PS – 2 Nos.	

The detailed **Qualifying Requirements (QR) and Technical Evaluation Criteria** have been provided in the Bidding Document.

- 4.0 The **completion period** for the subject packages shall be the period as specified in Special Conditions of Contract (Section – IV) of the bidding documents.
- 5.0 CTUIL intends to use **domestic funding** for eligible payments under the contract for the packages mentioned above.
- 6.0 CTUIL, therefore, invites Proposals through GeM portal for **Appointment of Independent Engineer for “Transmission system for evacuation of power from Rajasthan REZ Ph-IV (Part-3: 6GW) [Bikaner complex]: Part-B”** on Domestic Competitive Bidding basis for engagement of Independent Engineer using **Quality and Cost Based Selection (QCBS)** procedures under secured e-procurement procedure.

The following documents constitute the RfP document to enable Bidders to submit their Proposals:

- a) Section – I: Request for Proposals;
 - b) Section – II: Terms of Reference (ToR);
 - c) Section – III: Conditions of Contract;
 - d) Section – IV: Special Conditions of Contract;
 - e) Section- V: Proposal Forms (Technical & Financial), Attachments & Schedule
- 6.1 This Request for Proposals extended through media, website, written communication or by any other means, and issuance of RfP Documents shall not be construed to mean that the prospective Bidders to whom the Request for

Proposal has been extended and/or RfP Documents have been issued is deemed to be an eligible Bidder. The eligibility of the Bidders shall be determined as per the provisions of RfP Documents.

6.2 Bidding will be conducted through Open Tender bidding procedures as per the provisions of RfP Documents and the contract shall be executed as per the provisions of the Contract. The respective rights of the Employer and the Independent Engineer shall be governed by the RfP Documents.

7.0 The complete Bidding Documents are available on GeM portal <https://bidplus.gem.gov.in/all-bids> . Interested bidders shall download the Bidding Documents from the GeM portal, as per the provisions available therein.

Bidders shall ensure that their bids, complete in all respects, are submitted online through said Portal only. No DEVIATION in this regard is acceptable.

8.0 Interested bidders have to necessarily register themselves on the GeM portal <https://mkp.gem.gov.in/registration/signup#!/seller> to participate in the bidding under this Request for Proposal.

Bidders are advised to start the registration process on the e-Procurement Portal, as it may take a few days so as to avoid any delay in bid submission (upload) stage. Bidders may visit/communicate to GeM helpdesk regarding any query related to GeM portal.

It shall be the sole responsibility of the interested bidders to get themselves registered at the aforesaid portal and for any assistance during bid submission, system settings etc. for which they are required to contact GeM helpdesk: <https://gem.gov.in/contactUs>

Toll Free Numbers (Inbound): Call

1800-419-3436 / 1800-102-3436

(9:00 am - 10:00 pm Mon to Sat)

HelpDesk Outbound No's : 07556681401, 07556685120, 01169095625

Railway Helpline: 011-44022666

Defence Helpline: 0755-6681450

Email: helpdesk-gem@gov.in

**HelpDesk Walk-In Address: 2nd Floor, Jeevan Tara Building, 5-Sansad Marg,
Near Patel Chowk, New Delhi-110001**

They may obtain further information regarding this RfP from the office of Manager/ Engineer, CTUIL at the address given at **para 14.0** below from 15:00 hours to 17:00 hours on all working days.

For proper uploading of the proposals on the portal namely <https://gem.gov.in/> (hereinafter referred to as the 'portal'), it shall be the sole responsibility of the bidders to apprise themselves adequately regarding all the relevant procedures and provisions as detailed at the portal as well as by contacting **GeM portal** directly, as and when required, for which contact details are mentioned above. The Employer in no case shall be responsible for any issues related to timely or properly uploading/submission of the bid in accordance with the relevant provisions of the Bidding Documents.

9.0 A **Single Stage Two Envelope Bidding Procedure** will be adopted and will proceed as detailed in the Bidding Documents.

10.0 **e-Reverse Auction (e-RA)**

The electronic Reverse Auction (e-RA) is not applicable.

11.0 A **pre-bid meeting** will be held on **02.12.2024 at 1100 Hrs. (IST)** to clarify the bidder's various issues raised in accordance with clause **5.2** of Section - III: Conditions of Contracts.

12.0 **Soft Copy Part of the Proposals** must be uploaded under Single Stage Two Envelope Bidding Procedure on the GeM portal at or before **15:00 hours on 16.12.2024**. The e-Procurement system would not allow any late submission of proposals through the portal after the due date & time as specified.

Hard Copy Part of the Proposals must be submitted under Single Stage Two Envelope Bidding Procedure at the address given at para 14.0 below at or before **15:00 hours on 16.12.2024**. Late submission of proposals shall not be allowed.

First Envelope i.e., Techno-Commercial Part shall be opened on **16.12.2024** in the presence of the bidders' representatives who choose to attend in person at the address at para 15.0 below at **15:30 hours** or may be viewed by the bidders by logging in to the portal. Second Envelope i.e., Price Part of qualified bidders shall be opened in the presence of the bidders' representatives who choose to attend at the time and date and at the address given in the intimation for opening of Second Envelope through GeM portal itself in accordance with **Clause 21.0 of Section - III: Conditions of Contracts** or may be viewed by the bidders by logging in to the GeM portal.

All proposals must be accompanied by **Proposal Security in line with Clause 11.0 of Section-III/Section-IV of Bidding Document**. Proposal Securities must be submitted either in physical form or paid online.

Proposal Securities, Integrity Pact, Power of Attorney must be submitted in physical form or documentary evidence of online payment of the specified amount to CTUIL at the address given at para 14.0 below on or before **15:00 hours on**

16.12.2024. CTUIL shall not be responsible for any postal delay in respect of submission of hard copy part of the bids.

13.0 CTUIL reserves the right to cancel/withdraw this Request for Proposals without assigning any reason and shall bear no liability whatsoever consequent upon such a decision.

14.0 All correspondence with regards to the above shall be to the following address:

(By Post/In Person)

Central Transmission Utility of India Limited
(A wholly owned subsidiary of POWERGRID)
10th floor, IRCON International Tower-1, Plot No. 16
Sector-32, Gurugram – 122001, Haryana

Kind Attention: Mr. Dwaipayan Sen (Manager, C&M-CTUIL /
Mr. Rahul (Manager, C&M-CTUIL)

Mobile: +91-9205287422/9205472328

Email: dwaipayan@powergrid.in; rahul.prasad@powergrid.in

Note: Bidders may download the word file of the RfP document from CTUIL Portal.

----- End of RfP -----

TERMS OF REFERENCE (TOR)

for

Appointment of Independent Engineer for "Transmission system for evacuation of power from Rajasthan REZ Ph-IV (Part-3: 6GW) [Bikaner complex]: Part-B"

(Spec. No. CTUIL/IE/2024-25/58)

CONTENTS

S. No.	Description	Page No.
1	Introduction & Background	3
2	The Independent Engineer	3
3	Objective of the Assignment	3
4	Scope of Work	4
5	Dispute Resolution	9
6	Authorised Signatories	9
7	Deliverables	10
8	Team Composition	11
9	Termination of Appointment	13

TERMS OF REFERENCE (TOR) FOR INDEPENDENT ENGINEER

1. Introduction & Background

- 1.1 These Terms of Reference for the Independent Engineer (the “TOR”) are being specified pursuant to the Transmission Service Agreement (TSA) entered into between the Employer (the “CTUIL”) and Transmission Service Provider (the “TSP”) for the transmission project “**Transmission system for evacuation of power from Rajasthan REZ Ph-IV (Part-3: 6GW) [Bikaner complex]: Part-B**” under Tariff Based Competitive Bidding (TBCB) route (**copy of which is annexed hereto and marked as Annexure-A1 to form part of this TOR**).

2. The Independent Engineer (IE)

- 2.1 The Independent Engineer shall be a company registered or incorporated in India as per Companies Act, 2013 or Companies Act, 1956.
- 2.2 The Independent Engineers’ team of key personnel will comprise Project Manager, and experts in different disciplines, having requisite experience of similar type of works (as mentioned in clause 8.1) required for the contract. The Independent Engineer will have to deploy only personnel who have the specified relevant qualification and experience.
- 2.3 The Independent Engineer shall discharge its duties in a fair, impartial and efficient manner, consistent with the highest standards of professional integrity and Good Industry Practice. Independent Engineer shall not have any affiliation with any Transmission Service Provider (TSP) undertaking the subject transmission scheme.

3. Objective of the Assignment

- 3.1 The overall objective of the assignment is to monitor the execution/construction of substations, transmission lines, underground cables, communication systems etc on behalf of the employer (CTUIL) for the transmission projects awarded to the TSP under Tariff Based Competitive Bidding (TBCB) route within the framework of TSA.

3.2 Roles and functions of Independent Engineer

The role and functions of the Independent Engineer shall include the following:

- a) Progress Monitoring
- b) Ensuring Quality

- c) Determining the costs of any works or services and/or their reasonableness during construction phase;
- d) Determining the period or any extension thereof, for performing any duty or obligation during construction phase;
- e) Determining the valuation of the Project Assets.
- f) Assisting the employer in resolution of disputes and determining validity of change in law or force majeure conditions and their effects on the parties (employer, TSP, CEA or any related agency).
- g) Undertaking all other duties and functions in accordance with the Transmission Service Agreement.

4. Scope of Work

4.1 Transmission Line

Independent Engineer shall check in accordance with the provisions of RfP (for TBCB projects):

1. Selection of tower type provided by TSP has been as per regulations/specifications mentioned in the RfP.
2. Tower has been prototype tested as per relevant standards.
3. Applicability of multicircuit towers in line passing through forest areas as per provisions of RfP and regulations/ specifications.
4. Detailed specifications of conductor meeting the functional specifications specified in RFP.
5. Specifications of Transmission line equipment (i.e. insulator, earthwire, OPGW, associated accessories, hardware fittings, aviation lights etc) with respect to the regulations/standards and specifications mentioned in RfP document by going through GTP, drawings & test reports provided by TSP.

4.2 Substation

Independent Engineer shall check in accordance with the provisions of RfP (for TBCB projects):

1. SLD & GA prepared by TSP for conformity with the present scope of work as well as future provisions.
2. Switching Scheme, Installation type (AIS/GIS/Hybrid/MTS), feeder distribution /bay configuration and ratings of bus-bars/bay equipment of the substation in accordance with the provisions of RfP.
3. Specifications of the substation equipment (i.e. Circuit Breakers, Isolators, Instrument Transformers, Surge Arrestors, Protection system, PLCC, Communication equipment, Transformers, Reactors, auxiliaries etc.) installed by TSP with respect to the regulations/standards and specifications mentioned in RfP document by going through GTP, drawings, type test reports provided by TSP.
4. Ratings of auxiliary system viz LT Transformers, battery banks, battery chargers, LT switchgear, DG Set, Fire protection system, Visual monitoring system installed by TSP and ensure that selected rating is suitable for the scope of work (present scope & future provisions).
5. Coverage/suitability of bus-bar protection and Substation Automation System (SAS) for the complete scope of work (present scope & future provisions).
6. Line Gantry/Towers for adjacent future line bay are suitable for extension, wherever applicable.
7. Specifications of the STATCOM equipment (**if applicable**) including MSR, MSC, VSC Valves, coupling transformer, MV switchgear, instrument transformer, surge arrester etc. installed by TSP with respect to the regulations/standards and specifications mentioned in RfP document by going through GTP, drawings, type test reports provided by TSP.

The independent Engineer shall review the GTP, Drawings & Test reports (type, routine, acceptance tests) provided by TSP and any abnormality observed with respect to RfP provisions shall be reported by IE to employer immediately.

4.3 Quality & Construction Monitoring

1. The Independent Engineer shall follow up with the TSP to get the approved MQP & FQP submitted after award of contract(s) on priority and maximum within one hundred and twenty (120) days from the Effective Date of TSA.
2. The Independent Engineer, through its Field Engineer would check the records maintained by TSP, and verify that the Project is built and completed in good

workmanship using sound engineering & construction practices; using materials/equipment that are newly manufactured as per the MQP and following the approved FQP for construction, erection, testing & commissioning.

3. The Independent Engineer shall verify, through documentation provided by TSP (i.e. GTP, drawings, test reports, MQP etc.), that following major substation equipment/ items, transmission line materials have been provided in accordance with relevant CEA Regulations and Indian Standards (in case Indian Standards for any particular equipment/ system/ process is not available, IEC/ IEEE or equivalent International Standards and Codes shall be followed).
 - Transformers, Reactors, Circuit Breakers, Instrument Transformers, Surge Arresters, Protection relays, clamps & connectors, GIS equipment/bus duct etc.
 - Equipment in terminal stations of HVDC installations including Thyristor/ IGBT valves, Converter Transformers, smoothing reactors, Transformer bushings and wall bushings etc.
 - Towers and gantry structures inside the AC/DC substation.
 - Transmission line towers/poles, Conductors, earthwire, OPGW, insulator, associated accessories, hardware fittings for insulators, aviation lights etc.
4. The Independent Engineer shall monitor the quality of construction materials, foundation and workmanship through visual inspection, documentation & test reports etc. provided by TSP (FQP etc) and through field visits, wherever required.
5. The Independent Engineer shall verify that the Tower types installed for crossing power lines, railways, national highways and state highways by TSP has been in accordance with the RfP. Further, IE shall also verify compliance to rules/regulations of railways and other relevant Highway authorities for crossings of power lines, railways, national highways and state highways.
6. Independent Engineer shall ensure conformity of the conductor specifications with the functional specifications specified in RFP.
7. The Independent Engineer shall verify that Site Acceptance Test (SAT)/ pre-commissioning tests of all major substation equipment, component, system, facilities have been successfully carried out before commissioning by checking the records maintained by TSP. Further, Independent Engineer shall ensure that

the Type tests, FAT and SAT reports are available at the substation / terminal station of HVDC installations for future ready reference.

8. Independent Engineer (Project Manager/ Experts) shall carry out inspections during the Project execution, as and when deemed necessary **or as directed by Employer.**
9. Independent Engineer shall check that TSP is following Cyber security compliances, import from neighbouring countries as per Finance ministry regulations, Make in India compliances, MLC compliances and any other statutory regulations imposed by the Govt. from time to time as required under RfP/TSA.
10. The Independent Engineer shall assist in taking remedial action to avoid slippages leading to delay in completion of works by the TSP.
11. The Independent Engineer shall also assist in any allied activities deemed necessary for successful and timely completion of work during contract execution.

4.4 Progress Monitoring

1. The Independent Engineer shall follow up with the TSP to get the Project Execution Plan submitted after award of contract(s) on priority and maximum within one hundred and twenty (120) days from the Effective Date of Transmission Service Agreement (TSA).

The Project Execution Plan submitted by the TSP shall comprise detailed schedule of all the equipment/items/materials required for the Project, right from placement of award till the dispatch from works and receipt at the site. Further, it should also include various stages of the construction schedule up to the commissioning of the Project.

The Independent Engineer shall review Project Execution Plan submitted by the TSP which includes organization structure, time plan and methodology for executing the Project, award of major contracts, designing, engineering, procurement, shipping, construction, testing and commissioning in conformity with the Scheduled COD as specified in Schedule 2 of Transmission Service Agreement (TSA).

2. Independent Engineer shall review the monthly progress reports to be submitted by TSP. The forms for submission of monthly progress report shall be finalised by Independent Engineer with the TSP. The reports should mention likely

completion date of each Element with regard to the Project and its execution (in accordance with prescribed form).

3. The Independent Engineer shall monitor the development of the Project for its timely completion. The progress shall be reviewed by the Independent Engineer against the Project Execution Plan. The Independent Engineer shall prepare its report on monthly basis and submit the same to Employer highlighting the progress achieved till the end of respective month vis-à-vis milestone activities, areas of concern, if any, which may result in delay in the timely completion of the Project.
4. The monthly progress report shall include an overview of the status of work at site, quality of construction, safety measures/aspects, the source of materials used and conformity of Construction Works with the Scope of the Project with high resolution photographs of the inspected equipment/site works. Further, status of ROW, forest clearance, PTCC clearance, approval of Supreme Court appointed committee for GIB areas etc. to be mentioned in the progress report.
5. The monthly progress report shall include the compliance of all the equipment/materials received at site in particular month with respect to provisions of RfP/standards/ regulations. In case of any non-conformity in product/services/work, analysis shall be carried out by the Independent Engineer and corrective actions shall be suggested for any work, whenever there is any deviation observed in the drawings, specifications/ parameters, work methods or construction.
6. The Independent Engineer shall review the detailed bar (GANTT) chart of the Project outlining each activity (taking longer than one Month), linkages as well as durations as submitted by the TSP.

The Independent Engineer shall monitor the progress of works as per the approved GANTT bar chart, certify the achievement of contractual milestones defined and keep TSP advised about possible bottlenecks while recommending actions to mitigate the same.

They shall compile systematic records of TSP's site activities to adequately document the progress and performance of the work. These records shall support determination of responsibility for slow progress of contracts.

7. Independent Engineer shall verify the readiness of the elements including the statutory clearances & completion of civil works, fixing of all components and finalisation of punch points (if any) prior to charging of the elements.

8. The reports/observations of the IE shall be submitted to both the Employer and the TSP and suggest corrective measures, if any.

4.5 Other duties and functions

1. Independent Engineer shall undertake all other duties and functions in accordance with the Transmission Service Agreement, whenever referred by the Employer.
2. Independent Engineer shall depute its substation/ transmission line experts for witnessing the type tests/ FAT at manufacturers location whenever desired by the Employer. The travel/ accommodation expenses of the same shall be reimbursed as per the rates mentioned in bidding document.

5. Dispute Resolution:

- 5.1 Any disputes with regard to works being executed by the TSP shall be resolved in the most amicable manner in accordance with the provisions of the contract.
- 5.2 The Independent Engineer shall examine and make recommendations on claims received from the TSPs for time extension, extra work or expenses etc. arising due to change in law or Force Majeure. In this respect, the Independent Engineer shall certify positive and negative quantity deviation with respect to the contracted quantities, review justification and costing prepared by the TSP.

The proposals for cost variations shall be processed in the shortest possible time duly coordinated with the TSP and the Employer.
- 5.3 If Transmission Service Agreement (TSA) is terminated on account of Force Majeure Events, non-requirement of any Element or Project during Construction, Employer's non-fulfilment of Role & TSP's Event of Default, the TSP shall be entitled for Termination Payment equivalent to valuation of Project Assets. The Independent Engineer shall determine the valuation of the Project Assets in case of such events as required under Transmission Service Agreement, whenever referred by Employer.
- 5.4 The Independent Engineer shall determine the costs of any works or services and/or their reasonableness during construction phase as required under Transmission Service Agreement, whenever referred by Employer.
- 5.5 The Independent Engineer shall assist the Parties in resolution of Disputes, whenever such dispute is referred by Employer.

5.6 Organize and conduct meetings as desired by Employer and submit reports/ proceedings of the meetings to Employer.

6. Authorised signatories

Independent Engineer shall designate and notify up to 2 (two) persons employed in its firm to sign for and on behalf of the Independent Engineer, and any communication or document required to be signed by the Independent Engineer shall be valid and effective only if signed by any of the designated persons; provided that the Independent Engineer may, by notice in writing, substitute any of the designated persons by any of its employees.

7. Deliverables:

The Independent Engineer shall be responsible for following deliverables (the “Deliverables”) during the course of this Consultancy.

7.1 Monthly Report

The progress of the TBCB projects shall be reviewed by the Independent Engineer against the Project Execution Plan of TSP. The Independent Engineer shall prepare its report on monthly basis and submit the same to Employer highlighting the progress achieved till the end of respective month vis-a-vis milestone activities, areas of concern, if any, which may result in delay in timely completion of the Project.

Such progress report shall include an overview of the status, progress, quality and safety of construction, including the work methodology adopted, the materials used and their sources, and conformity of Construction Works with the Scope of the Project and the Specifications and Standards along with High resolution photographs of the inspected equipment. Based on the progress, Employer and/ or CEA shall issue written instructions to the TSP to take corrective measures, as may be prudent for the timely completion of the Project.

7.2 Completion Report

Final completion report of the project in respect of all elements of the Project shall be compiled along with as-built SLD, GA, earthing drawing and shall be submitted to the Employer.

7.3 Documentation

The Independent Engineer shall provide to Employer soft copies of the following documents/ details, as and when finalized by TSP:

- Co-ordinates of substation land.
- SLD, General Arrangement & Electrical layout drawing of substation
- Earthmat layout
- SAS Architecture
- Bus bar protection scheme
- Fire Protection system layout
- LT Switchgear layout
- Foundation & cable trench layout
- Route survey of Transmission line
- Type & number of Towers finalized for Transmission line including river, railway, highway crossing etc.

8. Team Composition

The Independent Engineer shall provide experienced personnel to carry out the assignment throughout the duration of the project management services in accordance with task/requirement of the project.

8.1 The team shall include the following key personnel:

Sl. No.	Position	Experience and Qualification requirements of key experts
1.	Team Leader cum Project Manager	The Team Leader shall be responsible for overall coordination of the consultancy services to ensure satisfactory fulfillment of contracted services. He shall join important review meetings in Employer offices/ at sites and otherwise, also keep himself updated about the progress of the assignment and provide guidance to team, as needed. He shall be responsible for submission of the progress and other reports included in the assignment. He shall coordinate with all stakeholders (including senior state government officials and Client management) and oversee

Sl. No.	Position	Experience and Qualification requirements of key experts
		<p>satisfactory delivery of services.</p> <p>He/ She should be Graduate in Electrical/ Mechanical / Civil Engineering having at least 8 years' experience in EHV transmission projects and have worked in at least two (2) assignments for 345kV or above transmission project as team leader/Project Manager.</p>
2.	Substation Expert	Graduate in Electrical Engineering having at least 5 years' experience in EHV transmission substation projects and have worked in at least two (2) assignments for 345kV or above substation projects.
3.	Transmission Line Expert	Graduate in Electrical/ Civil Engineering having at least 5 years' experience in EHV transmission line projects and have worked in at least two (2) assignments for 345kV or above transmission line projects.
4.	Field Engineer-I (Substation)	Graduate/Diploma in Electrical/Civil Engineering having at least 2 years' experience in construction of EHV transmission substation projects. Field Engineer shall be posted at site during contract period.
5.	Field Engineer-II (Substation)	Graduate/Diploma in Electrical/Civil Engineering having at least 2 years' experience in construction of EHV transmission substation projects. Field Engineer shall be posted at site during contract period.
6.	Field Engineer-I (Transmission Line):	Graduate/Diploma in Electrical/Civil Engineering having at least 2 years' experience in construction of EHV transmission line projects. Field Engineer shall be posted at site during contract period.

Sl. No.	Position	Experience and Qualification requirements of key experts
7.	Field Engineer-II (Transmission Line):	Graduate/Diploma in Electrical/Civil Engineering having at least 2 years' experience in construction of EHV transmission line projects. Field Engineer shall be posted at site during contract period.

Note: The Key Personnel shall preferably be an employee of Bidder. In case the Key Personnel is being hired by the bidder, the bidder needs to furnish a declaration with bid mentioning the nature of engagement to ensure his availability in the event of award. After award of contract, hiring agreement between Independent Engineer & Key personnel shall be furnished by successful bidder to CTU within 15 days from the issuance of GeM Contract Orders.

9. Termination of appointment

9.1 If the TSP has reason to believe that the Independent Engineer is not discharging its duties and functions in a fair, efficient and diligent manner, it may make a written representation to the Employer and seek termination of the appointment of the Independent Engineer.

Upon receipt of such representation, the Employer shall hold a tripartite meeting with the TSP and Independent Engineer for an amicable resolution, and the decision of Employer shall be final.

9.2 The Employer may, in its discretion, terminate the appointment of the Independent Engineer at any time.

TRANSMISSION SERVICE AGREEMENT

FOR

**DEVELOPMENT AND OPERATION OF INTER-
STATE TRANSMISSION SYSTEM**

**FOR TRANSMISSION OF ELECTRICITY
THROUGH TARIFF BASED COMPETITIVE
BIDDING FOR**

**TRANSMISSION SYSTEM FOR EVACUATION OF
POWER FROM RAJASTHAN REZ PH-IV
(PART-3: 6 GW) [BIKANER
COMPLEX]: PART B**

BETWEEN THE

**CENTRAL TRANSMISSION UTILITY OF INDIA
LIMITED
(NODAL AGENCY)**

AND

BIKANER B POWER TRANSMISSION LIMITED

November....., 2024

CONTENTS

1	Definitions and Interpretations.....	6
2	Effectiveness and Term of Agreement.....	18
3	Conditions Subsequent.....	20
4	Development of the Project.....	24
5	Construction of the Project.....	28
6	Connection and commissioning of the Project.....	33
7	Operation and Maintenance of the Project.....	38
8	Availability of the project.....	39
9	Insurances.....	40
10	Billing And Payment of Transmission Charges.....	42
11	Force Majeure.....	43
12	Change in Law.....	48
13	Events of Default and Termination.....	51
14	Liability and Indemnification.....	56
15	Assignments and Charges.....	61
16	Governing Law and Dispute Resolution.....	63
17	Representation and Warranties.....	65
18	Independent Engineer.....	67
19	Miscellaneous Provisions.....	69

THIS TRANSMISSION SERVICE AGREEMENT (hereinafter referred to as “TSA” or “Agreement” or “the Agreement” or “this Agreement”) is made on the [Insert day] of..... [Insert month] of Two Thousand and 2024

BETWEEN:

The **Central Transmission Utility of India Limited**, having its registered address at "Saudamini",1st Floor, Plot No. 2, Sector-29, Gurugram-122001, Haryana and correspondence address at 5th to10th Floor, Ircon International Tower, Tower no-1, Plot no -16 , Sector-32, Gurugram, Haryana-122003, acting as a Nodal Agency (referred to as the “Nodal Agency”), which expression shall unless repugnant to the context or meaning thereof include its successors, and permitted assigns) as Party of the one part;

AND

Bikaner B Power Transmission Limited incorporated under the Companies Act, 2013, having its registered office at Core-4, Scope Complex 7, Lodhi Road Delhi, South Delhi, Delhi 110003 (herein after referred to as “Transmission Service Provider” or “TSP” or “ISTS Licensee”, which expression shall unless repugnant to the context or meaning thereof include its successors, and permitted assigns) as Party of the other part;

(“Nodal Agency” and “TSP” are individually referred to as “Party” and collectively as the “Parties”)

AND WHEREAS:

- A) In accordance with the Bidding Guidelines, the Bid Process Coordinator (hereinafter referred to as BPC) had initiated a competitive e-reverse bidding process through issue of RFP for selecting a Successful Bidder to build, own, operate and transfer the Project comprising of the Elements mentioned in Schedule 1 (hereinafter referred to as the Project)
- B) Pursuant to the said e-reverse bidding process, the BPC has identified the Successful Bidder, who will be responsible to set up the Project on build, own, operate and transfer basis to provide Transmission Service in accordance with the terms of this Agreement and the Transmission License.
- C) The Selected Bidder have submitted the Contract Performance Guarantee and acquired one hundred percent (100%) of the equity shareholding of Bikaner B Power Transmission Limited, along with all its related assets and liabilities in terms of the provisions of the Share Purchase Agreement.
- D) The TSP has agreed to make an application for a Transmission License to the Commission for setting up the Project on build, own, operate and transfer basis.
- E) The TSP has further agreed to make an application to the Commission for the adoption of the Transmission Charges under Section 63 of the Electricity Act, 2003, along with a certification from the Bid Evaluation Committee in accordance with the Bidding Guidelines issued by Ministry of Power, Government of India.
- F) The TSP has agreed to execute the agreement(s) required, if any, under Sharing Regulations within fifteen (15) days from the date of grant of Transmission License from the Commission.
- G) The TSP agrees to the terms and conditions laid down under Sharing Regulations, for making available the ISTS and charge the Transmission Charges in accordance with the terms and conditions of Sharing Regulations.
- H) The billing, collection and disbursement of the Transmission Charges by the CTU to the ISTS Licensee shall be governed as per Sharing Regulations.
- I) The terms and conditions stipulated in the Transmission License issued by the Commission to the TSP shall be applicable to this Agreement and the TSP agrees to comply with these terms and conditions. In case of inconsistency between the Transmission License terms & conditions and the conditions of this Agreement, the conditions stipulated in the Transmission License granted by the Commission shall prevail.

NOW, THEREFORE, IN CONSIDERATION OF THE PREMISES AND MUTUAL AGREEMENTS, COVENANTS AND CONDITIONS SET FORTH HEREIN, IT IS HEREBY AGREED BY AND BETWEEN THE PARTIES HERETO AS FOLLOWS:

ARTICLE: 1

1 DEFINITIONS AND INTERPRETATIONS

1.1 Definitions:

- 1.1.1 The words / expressions used in this Agreement, unless as defined below or repugnant to the context, shall have the same meaning as assigned to them by the Electricity Act, 2003 and the rules or regulations framed there under including those issued / framed by the Commission (as defined hereunder), as amended or re-enacted from time to time or the General Clauses Act, failing which it shall bear its ordinary English meaning.

The words/expressions when used in this Agreement shall have the respective meanings as specified below:

“Acquisition Price” shall have the same meaning as defined in the Share Purchase Agreement;

“Act” or **“Electricity Act”** or **“Electricity Act 2003”** shall mean the Electricity Act, 2003 and any amendments made to the same or any succeeding enactment thereof;

“Affiliate” shall mean a company that either directly or indirectly

- i. controls or
- ii. is controlled by or
- iii. is under common control with

a Bidding Company (in the case of a single company) or a Member (in the case of a Consortium) and **“control”** means ownership by one entity of at least twenty six percent (26%) of the voting rights of the other entity;

“Availability” in relation to the Project or in relation to any Element of the Project, for a given period shall mean the time in hours during that period the Project is capable to transmit electricity at its Rated Voltage and shall be expressed in percentage of total hours in the given period and shall be calculated as per the procedure contained in Appendix –IV to Central Electricity Regulatory Commission (Terms and Conditions of Tariff) Regulations, 2024, attached herewith in Schedule 6;

“Bid” shall mean technical bid and financial bid submitted by the Bidder, in response to the RFP, in accordance with the terms and conditions of the RFP;

“Bid Deadline” shall mean the last date and time for submission of the Bid in response to RFP, as specified in the RFP;

“Bidding Company” shall refer to such single company that has made a Response to RFP for the Project;

“Bidding Consortium / Consortium” shall refer to a group of companies that has collectively made a Response to RFP for the Project;

“Bid Documents” or **“Bidding Documents”** shall mean the RFP, along with all attachments thereto or clarifications thereof;

“Bidding Guidelines” shall mean the “Tariff Based Competitive Bidding Guidelines for Transmission Service” and “Guidelines for Encouraging Competition in Development of Transmission Projects” issued by Government of India, Ministry of Power under Section – 63 of the Electricity Act as amended from time to time;

“Bid Process Coordinator” or **“BPC”** shall mean a person or its authorized representative as notified by the Government of India, responsible for carrying out the process for selection of Bidder who will acquire Transmission Service Provider;

“Bill” shall mean any bill raised by the CTU on the DICs to recover the Transmission Charges pursuant to the Sharing Regulations;

“Business Day” shall mean a day other than Sunday or a statutory holiday, on which the banks remain open for business in the State in which the Nodal Agency’s registered office is located and the concerned TSP are located;

“CEA” shall mean the Central Electricity Authority constituted under Section - 70 of the Electricity Act;

“Change in law” shall have the meaning ascribed thereto in Article 12;

“Commercial Operation Date” or **“COD”** shall mean the date as per Article 6.2;

“Commission” or **“CERC”** shall mean the Central Electricity Regulatory Commission referred to in sub-section (1) of Section 76 of the Electricity Act, 2003 or its successors and assigns;

“Competent Court of Law” shall mean the Supreme Court or any High Court, or any tribunal or any similar judicial or quasi-judicial body in India that has jurisdiction to adjudicate upon issues relating to the Project;

“Connection Agreement” shall mean the agreement between the CTU or STU or any other concerned parties and the TSP, setting out the terms relating to the connection of the Project to the Inter-connection Facilities and use of the Inter State Transmission System as per the provisions of the IEGC, as the case may be;

“Consultation Period” shall mean the period of sixty (60) days or such longer period as the Parties may agree, commencing from the date of issue of a TSP’s Preliminary Notice or a Nodal Agency’s Preliminary Termination Notice, as provided in Article 13 of this Agreement, for consultation between the Parties to mitigate the consequence of the relevant event having regard to all the circumstances;

“Consents, Clearances and Permits” shall mean all authorizations, licenses, approvals, registrations, permits, waivers, privileges, acknowledgements, agreements, or concessions required to be obtained from or provided by any concerned authority for the development, execution and operation of Project including without any limitation for the construction, ownership, operation and maintenance of the Transmission Lines and/or sub-stations;

“Construction Period” shall mean the period from (and including) the Effective Date of the Transmission Service Agreement up to (but not including) the COD of the Element of the Project in relation to an Element and up to (but not including) the COD of the Project in relation to the Project;

“Contractors” shall mean the engineering, procurement, construction, operation & maintenance contractors, surveyors, advisors, consultants, designers, suppliers to the TSP and each of their respective sub-contractors (and each of their respective successors and permitted assigns) in their respective capacities as such;

“Contract Performance Guarantee” shall mean the irrevocable unconditional bank guarantee, submitted and to be submitted by the TSP or by the Selected Bidder on behalf of the TSP to the Nodal Agency from a bank mentioned in Annexure 17 of the RFP, in the form attached here to as Schedule 8, in accordance with Article 3 of this Agreement and which shall include the additional bank guarantee furnished by the TSP under this Agreement;

“Contract Year”, for the purpose of payment of Transmission Charges, shall mean the period beginning on the COD, and ending on the immediately succeeding March 31 and thereafter each period of 12 months beginning on April 1 and ending on March 31 provided that the last Contract Year shall end on the last day of the term of the TSA;

“CTU” or **“Central Transmission Utility”** shall have same meaning as defined in the Electricity Act, 2003;

“Day” shall mean a day starting at 0000 hours and ending at 2400 hours;

“D/C” shall mean Double Circuit;

“Designated ISTS Customers” or **“DICs”** shall have the meaning as ascribed in the Sharing Regulations;

“Dispute” shall mean any dispute or difference of any kind between the Parties, in connection with or arising out of this Agreement including any issue on the interpretation and scope of the terms of this Agreement as provided in Article 16;

“Effective Date” for the purposes of this Agreement, shall have the same meaning as per Article 2.1 of this Agreement;

“Electrical Inspector” shall mean a person appointed as such by the Government under sub-section (1) of Section 162 of the Electricity Act 2003 and also includes Chief Electrical Inspector;

“Electricity Rules 2005” shall mean the rules framed pursuant to the Electricity Act 2003 and as amended from time to time;

“Element” shall mean each Transmission Line or each circuit of the Transmission Lines (where there are more than one circuit) or each bay of Substation or switching station or HVDC terminal or inverter station of the Project, including ICTs, Reactors, SVC, FSC, etc. forming part of the ISTS, which will be owned, operated and maintained by the concerned ISTS Licensee, and which has a separate Scheduled COD as per Schedule 2 of this Agreement and has a separate percentage for recovery of Transmission Charges on achieving COD as per Schedule 5 of this Agreement;

“Event of Default” shall mean the events as defined in Article 13 of this Agreement;

“Expiry Date” shall be the date which is thirty five (35) years from the COD of the Project;

“Financial Closure” shall mean the first Business Day on which funds are made available to the TSP pursuant to the Financing Agreements;

“Financially Evaluated Entity” shall mean the company which has been evaluated for the satisfaction of the financial requirement set forth in the RFP;

“Financing Agreements” shall mean the agreements pursuant to which the TSP is to finance the Project including the loan agreements, security documents, notes, indentures, security agreements, letters of credit and other documents, as may be amended, modified, or replaced from time to time, but without in anyway increasing the liabilities of the Designated ISTS Customers / Nodal Agency;

“Financial Year” shall mean a period of twelve months at midnight Indian Standard Time (IST) between 1st April & 31st March;

“Force Majeure” and **“Force Majeure Event”** shall have the meaning assigned thereto in Article 11;

“GOI” shall mean Government of India;

“Grid Code” / “IEGC” shall mean the Grid Code specified by the Central Commission under Clause (h) of sub-section (1) of Section 79 of the Electricity Act;

“Independent Engineer” shall mean an agency/ company, appointed by Nodal Agency in accordance with the Guidelines for Encouraging Competition in Development of Transmission Projects.

“Indian Governmental Instrumentality” shall mean Government of India, Government of any State in India or any ministry, department, board, authority, agency, corporation, commission under the direct or indirect control of Government of India or any State Government or both, any political sub-division of any of them including any court or Commission or tribunal or judicial or quasi-judicial body in India but excluding the CTU, TSP and the Designated ISTS Customers;

“Insurances” shall mean the insurance cover to be obtained and maintained by the TSP in accordance with Article 9 of this Agreement;

“Interconnection Facilities” shall mean the facilities as may be set up for transmission of electricity through the use of the Project, on either one or both side of generating station's / CTU's / STU's / ISTS Licensee's / Designated ISTS Customer's substations (as the case may be) which shall include, without limitation, all other transmission lines, gantries, sub-stations and associated equipments not forming part of the Project;

“ISTS Licensee” shall be the TSP under this Agreement, consequent to having been awarded a Transmission License by the CERC and shall be referred to as the TSP or the ISTS Licensee, as the context may require in this Agreement;

“Law” or “Laws” in relation to this Agreement, shall mean all laws including electricity laws in force in India and any statute, ordinance, rule, regulation, notification, order or code, or any interpretation of any of them by an Indian Governmental Instrumentality having force of law and shall include all rules, regulations, decisions and orders of the Commission;

“Lead Member of the Bidding Consortium” or “Lead Member” shall mean a company who commits at least 26% equity stake in the Project, meets the technical requirement as specified in the RFP and so designated by other Member(s) in Bidding Consortium;

“Lenders” means the banks, financial institutions, multilateral funding agencies, non banking financial companies registered with the Reserve Bank of India (RBI), insurance companies registered with the Insurance Regulatory & Development Authority (IRDA), pension funds regulated by the Pension Fund Regulatory & Development Authority (PFRDA), mutual funds registered with Securities & Exchange Board of India (SEBI), etc., including their successors and assigns, who have agreed on or before COD of the Project to provide the TSP with the debt financing described in the capital structure schedule, and any successor banks or financial institutions to whom their interests under the Financing Agreements may be transferred or assigned;

Provided that, such assignment or transfer shall not relieve the TSP of its obligations to the Nodal Agency under this Agreement in any manner and shall also does not lead to an increase in the liability of the Nodal Agency;

“Lenders Representative” shall mean the person notified by the Lender(s) in writing as being the representative of the Lender(s) or the Security Trustee and such person may from time to time be replaced by the Lender(s) pursuant to the Financing Agreements by written notice to the TSP;

“Letter of Intent” or **“LOI”** shall have the same meaning as in the RFP;

“Member in a Bidding Consortium / Member” shall mean each company in the Bidding Consortium;

“Month” shall mean a period of thirty (30) days from (and excluding) the date of the event;

“Monthly Transmission Charges” for any Element of the Project, after COD of the Element till COD of the Project, and for the Project after COD of the Project, shall mean the amount of Transmission Charges as specified in Schedule 5 of this Agreement multiplied by no. of days in the relevant month and divided by no. of days in the year;

“National Load Despatch Centre” shall mean the centre established as per sub-section (1) of Section 26 of the Electricity Act 2003;

“Nodal Agency” shall mean CTU, which shall execute and implement the Transmission Service Agreement (TSA);

Provided that while taking major decisions, CTU shall consult CEA on technical matters and any other matter it feels necessary.

“Notification” shall mean any notification, issued in the Gazette of India;

“Operating Period” for any Element of the Project shall mean the period from (and including) the COD of such Element of the Project, up to (and including) the Expiry Date and for the Project, shall mean the period from (and including) the COD of the Project, up to (and including) the Expiry Date;

“Parent Company” shall mean an entity that holds at least twenty six percent (26%) of the paid-up equity capital directly or indirectly in the Bidding Company or in the Member in a Bidding Consortium, as the case may be;

“Preliminary Termination Notice” shall mean a Nodal Agency’s Preliminary Termination Notice as defined in Article 13 of this Agreement;

“Project” shall mean Transmission system for evacuation of power from Rajasthan REZ Ph-IV (Part-3: 6 GW) [Bikaner complex]: Part B, as detailed in Schedule 1 of this Agreement;

“Project Assets” shall mean all physical and other assets relating to and forming part of the Project including:

- (a) rights over the Site for substations, ROW for transmission lines;
- (b) tangible & intangible assets such as civil works and equipment including foundations, embankments, pavements, electrical systems, communication systems, relief centres, administrative offices, Sub-stations, software, tower and sub-stations designs etc;
- (c) project facilities situated on the Site;
- (d) all rights of the TSP under the project agreements;
- (e) financial assets, such as receivables, security deposits etc;
- (f) insurance proceeds; and
- (g) Applicable Permits and authorisations relating to or in respect of the Transmission System;”

“Project Execution Plan” shall mean the plan referred to in Article 3.1.3(c) hereof;

“Prudent Utility Practices” shall mean the practices, methods and standards that are generally accepted internationally from time to time by electric transmission utilities for the purpose of ensuring the safe, efficient and economic design, construction, commissioning, operation, repair and maintenance of the Project and which practices, methods and standards shall be adjusted as necessary, to take account of:

- (i) operation, repair and maintenance guidelines given by the manufacturers to be incorporated in the Project,
- (ii) the requirements of Law, and
- (iii) the physical conditions at the Site;
- (iv) the safety of operating personnel and human beings;

“Rated Voltage” shall mean voltage at which the Transmission System is designed to operate or such lower voltage at which the line is charged, for the time being, in consultation with the Central Transmission Utility;

“Rebate” shall have the meaning as ascribed to in Article 10.3 of this Agreement;

“RFP” shall mean Request for Proposal dated 06.06.2024 along with all schedules, annexures and RFP Project Documents attached thereto, issued by the BPC for tariff based competitive bidding process for selection of Bidder as TSP to execute the Project, including any modifications, amendments or alterations thereto;

“RFP Project Documents” shall mean the following documents to be entered into in respect of the Project, by the Parties to the respective agreements:

- a. Transmission Service Agreement,
- b. Share Purchase Agreement,
- c. Agreement(s) required under Sharing Regulations and
- d. Any other agreement as may be required;

“RLDC” shall mean the relevant Regional Load Dispatch Centre as defined in the Electricity Act, 2003, in the region(s) in which the Project is located;

“RPC” shall mean the relevant Regional Power Committee established by the Government of India for the specific Region(s) in accordance with the Electricity Act, 2003 for facilitating integrated operation of the Power System in that Region;

“Scheduled COD” in relation to an Element(s) shall mean the date(s) as mentioned in Schedule 2 as against such Element(s) and in relation to the Project, shall mean the date as mentioned in Schedule 2 as against such Project, subject to the provisions of Article 4.4 of this Agreement, or such date as may be mutually agreed among the Parties;

“Scheduled Outage” shall mean the final outage plan as approved by the RPC as per the provisions of the Grid Code;

“Selected Bid” shall mean the technical Bid and the Final Offer of the Selected Bidder submitted during e-reverse bidding, which shall be downloaded and attached in Schedule 7 on or prior to the Effective Date;

“Share Purchase Agreement” shall mean the agreement amongst REC Power Development and Consultancy Limited, Bikaner B Power Transmission Limited and the Successful Bidder for the purchase of one hundred (100%) per cent of the shareholding of the Bikaner B Power Transmission Limited for the Acquisition Price, by the Successful Bidder on the terms and conditions as contained therein;

“Sharing Regulations” shall mean the Central Electricity Regulatory Commission (Sharing of Inter-State Transmission Charges and Losses) Regulations, 2020 and as amended from time to time;

“Site” in relation to a substation, switching station or HVDC terminal or inverter station, shall mean the land and other places upon which such station / terminal is to be established;

“SLDC” shall mean the State Load Despatch Centre established as per sub-section (1) of Section 31 of the Electricity Act 2003;

“STU” or **“State Transmission Utility”** shall be the Board or the Government company, specified as such by the State Government under sub-section (1) of Section 39 of the Electricity Act 2003;

“Successful Bidder” or **“Selected Bidder”** shall mean the Bidder selected pursuant to the RFP and who has to acquire one hundred percent (100%) equity shares of Bikaner B Power Transmission Limited, along with all its related assets and liabilities, which will be responsible as the TSP to establish the Project on build, own, operate and transfer basis as per the terms of the TSA and other RFP Project Documents;

“TSP’s Preliminary Notice” shall mean a notice issued by the TSP in pursuant to the provisions of Article 13.3 of this Agreement;

“Target Availability” shall have the meaning as ascribed hereto in Article 8.2 of this Agreement;

“Technically Evaluated Entity” shall mean the company which has been evaluated for the satisfaction of the technical requirement set forth in RFP;

“Termination Notice” shall mean a Nodal Agency’s Termination Notice given by the Nodal Agency to the TSP pursuant to the provisions of Articles 3.3.2,

3.3.4, 4.4.2, 5.8, 13.2 and 13.3 of this Agreement for the termination of this Agreement;

“Term of Agreement” for the purposes of this Agreement shall have the meaning ascribed thereto in Article 2.2 of this Agreement;

“Transmission Charges” shall mean the Final Offer of the Selected Bidder during the e-reverse bidding and adopted by the Commission, payable to the TSP as per Sharing Regulations;

“Transmission License” shall mean the license granted by the Commission in terms of the relevant regulations for grant of such license issued under the Electricity Act;

“Transmission Service” shall mean making the Project available as per the terms and conditions of this Agreement and Sharing Regulations;

“Unscheduled Outage” shall mean an interruption resulting in reduction of the Availability of the Element(s) / Project (as the case may be) that is not a result of a Scheduled Outage or a Force Majeure Event.

“Ultimate Parent Company” shall mean an entity which owns at least twenty six percent (26%) equity in the Bidding Company or Member of a Consortium, (as the case may be) and in the Technically Evaluated Entity and / or Financially Evaluated Entity (as the case may be) and such Bidding Company or Member of a Consortium, (as the case may be) and the Technically Evaluated Entity and / or Financially Evaluated Entity (as the case may be) shall be under the direct control or indirectly under the common control of such entity;

1.2 Interpretation:

Save where the contrary is indicated, any reference in this Agreement to:

“Agreement” shall be construed as including a reference to its Schedules, Appendices and Annexures;

“Rupee”, “Rupees” and “Rs.” shall denote lawful currency of India;

“crore” shall mean a reference to ten million (10,000,000) and a **“lakh”** shall mean a reference to one tenth of a million (1,00,000);

“encumbrance” shall be construed as a reference to a mortgage, charge, pledge, lien or other encumbrance securing any obligation of any person or any other type of preferential arrangement (including, without limitation, title transfer and retention arrangements) having a similar effect;

"holding company" of a company or corporation shall be construed as a reference to any company or corporation of which the other company or corporation is a subsidiary;

"indebtedness" shall be construed so as to include any obligation (whether incurred as principal or surety) for the payment or repayment of money, whether present or future, actual or contingent;

"person" shall have the meaning as defined in Section 2 (49) of the Act;

"subsidiary" of a company or corporation (the holding company) shall be construed as a reference to any company or corporation:

- (i) which is controlled, directly or indirectly, by the holding company, or
- (ii) more than half of the issued share capital of which is beneficially owned, directly or indirectly, by the holding company, or
- (iii) which is a subsidiary of another subsidiary of the holding company,

for these purposes, a company or corporation shall be treated as being controlled by another if that other company or corporation is able to direct its affairs and/or to control the composition of its board of directors or equivalent body;

"winding-up", "dissolution", "insolvency", or "reorganization" in the context of a company or corporation shall have the same meaning as defined in the Companies Act, 1956/ Companies Act, 2013 (as the case may be).

- 1.2.1 Words importing the singular shall include the plural and vice versa.
- 1.2.2 This Agreement itself or any other agreement or document shall be construed as a reference to this or to such other agreement or document as it may have been, or may from time to time be, amended, varied, novated, replaced or supplemented.
- 1.2.3 A Law shall be construed as a reference to such Law including its amendments or re-enactments from time to time.
- 1.2.4 A time of day shall, save as otherwise provided in any agreement or document be construed as a reference to Indian Standard Time.
- 1.2.5 Different parts of this Agreement are to be taken as mutually explanatory and supplementary to each other and if there is any inconsistency between or among the parts of this Agreement, they shall be interpreted in a harmonious manner so as to give effect to each part.

Transmission Service Agreement

- 1.2.6 The tables of contents and any headings or sub-headings in this Agreement have been inserted for ease of reference only and shall not affect the interpretation of this Agreement.
- 1.2.7 All interest payable under this Agreement shall accrue from day to day and be calculated on the basis of a year of three hundred and sixty five (365) days.
- 1.2.8 The words “hereof” or “herein”, if and when used in this Agreement shall mean a reference to this Agreement.
- 1.2.9 The contents of Schedule 7 shall be referred to for ascertaining accuracy and correctness of the representations made by the Selected Bidder in Article 17.2.1 hereof.

ARTICLE: 2

2 EFFECTIVENESS AND TERM OF AGREEMENT

2.1 Effective Date:

This Agreement shall be effective from later of the dates of the following events:

- a. The Selected Bidder, on behalf of the TSP, has provided the Contract Performance Guarantee, as per terms of Article 3.1 of this Agreement; and
- b. The Selected Bidder has acquired for the Acquisition Price, one hundred percent (100%) of the equity shareholding of REC Power Development and Consultancy Limited in Bikaner B Power Transmission Limited along with all its related assets and liabilities as per the provisions of the Share Purchase Agreement. and
- c. The Agreement is executed and delivered by the Parties;

2.2 Term and Termination:

2.2.1 Subject to Article 2.2.3 and Article 2.4, this Agreement shall continue to be effective in relation to the Project until the Expiry Date, when it shall automatically terminate.

2.2.2 Post the Expiry Date of this Agreement, the TSP shall ensure transfer of Project Assets to CTU or its successors or an agency as decided by the Central Government at zero cost and free from any encumbrance and liability. The transfer shall be completed within 90 days of expiry of this Agreement failing which CTU shall be entitled to take over the Project Assets Suo moto.

2.2.3 This Agreement shall terminate before the Expiry Date in accordance with Article 13 or Article 3.3.2 or Article 3.3.4.

2.3 Conditions prior to the expiry of the Transmission License

2.3.1 In order to continue the Project beyond the expiry of the Transmission License, the TSP shall be obligated to make an application to the Commission at least two (2) years before the date of expiry of the Transmission License, seeking the Commission's approval for the extension of the term of the Transmission License up to the Expiry Date.

- 2.3.2 The TSP shall timely comply with all the requirements that may be laid down by the Commission for extension of the term of the Transmission License beyond the initial term of twenty-five (25) years & upto the Expiry Date and the TSP shall keep the Nodal Agency fully informed about the progress on its application for extension of the term of the Transmission License.

2.4 Survival:

The expiry or termination of this Agreement shall not affect any accrued rights, obligations/ roles and liabilities of the Parties under this Agreement, including the right to receive liquidated damages as per the terms of this Agreement, nor shall it effect the survival of any continuing obligations/ roles for which this Agreement provides, either expressly or by necessary implication, which are to survive after the Expiry Date or termination including those under Articles 3.3.3, 3.3.5, Article 9.3 (Application of Insurance Proceeds), Article 11 (Force Majeure), Article 13 (Events of Default and Termination), Article 14 (Liability & Indemnification), Article 16 (Governing Law & Dispute Resolution), Article 19 (Miscellaneous).

2.5 Applicability of the provisions of this Agreement

- 2.5.1 For the purpose of Availability, Target Availability and the computation of Availability, Incentive, Penalty, the provisions provided in this Agreement shall apply and any future modifications in the relevant Rules and Regulations shall not be applicable for this Project.
- 2.5.2 For the purposes of this Agreement for ISTS systems developed under the tariff based competitive bidding framework, the provisions relating to the definitions (Availability and COD), Article 3 (Contract Performance Guarantee and Conditions Subsequent), Article 5 (Construction of the Project), Article 6 (Connection and Commissioning of the Project), Article 8 (Target Availability and calculation of Availability), Article 11 (Force Majeure), Article 12 (Change in Law), Article 13 (Event of Default), Article 14 (Indemnification), Article 15 (Assignment and Charges), Articles 16.1, 16.2 and 16.4 (Governing Laws and Dispute Resolution) and Article 17 (representation and warranties of the ISTS Licensee) of this agreement shall supersede the corresponding provisions under Sharing Regulations.

ARTICLE: 3

3 CONDITIONS SUBSEQUENT

3.1 Satisfaction of conditions subsequent by the TSP

3.1.1 Within ten (10) days from the date of issue of Letter of Intent, the Selected Bidder, shall:

- a. Provide the Contract Performance Guarantee, and
- b. Acquire, for the Acquisition Price, one hundred percent (100%) equity shareholding of Bikaner B Power Transmission Limited from REC Power Development and Consultancy Limited, who shall sell to the Selected Bidder, the equity shareholding of Bikaner B Power Transmission Limited, along with all its related assets and liabilities.
- c. Execute this Agreement;

The TSP shall, within five (5) working days from the date of acquisition of SPV by the Selected Bidder, undertake to apply to the Commission for the grant of Transmission License and for the adoption of tariff as required under section-63 of the Electricity Act.

The Selected Bidder, on behalf of the TSP, will provide to the Central Transmission Utility of India Limited (being the Nodal Agency) the Contract Performance Guarantee for an amount of Rs. 139.50 Crore (Rupees One Hundred Thirty Nine Crore Fifty Lakh only).

3.1.2 The Contract Performance Guarantee shall be initially valid for a period up to three (3) months after the Scheduled COD of the Project and shall be extended from time to time to be valid for a period up to three (3) months after the COD of the Project. In case the validity of the Contract Performance Guarantee is expiring before the validity specified in this Article, the TSP shall, at least thirty (30) days before the expiry of the Contract Performance Guarantee, replace the Contract Performance Guarantee with another Contract Performance Guarantee or extend the validity of the existing Contract Performance Guarantee until the validity period specified in this Article.

3.1.3 The TSP agrees and undertakes to duly perform and complete the following activities within six (6) months from the Effective Date (except for c) below), unless such completion is affected due to any Force Majeure Event, or if any of the activities is specifically waived in writing by the Nodal Agency:

- a. To obtain the Transmission License for the Project from the Commission;

- b. To obtain the order for adoption of Transmission Charges by the Commission, as required under Section 63 of the Electricity Act 2003;
- c. To submit to the Nodal Agency, CEA & Independent Engineer, the Project Execution Plan, immediately after award of contract(s) and maximum within one hundred and twenty (120) days from the Effective Date. Also, an approved copy each of Manufacturing Quality Plan (MQP) and Field Quality Plan (FQP) would be submitted to Independent Engineer & Nodal Agency in the same time period. The TSP's Project Execution Plan should be in conformity with the Scheduled COD as specified in Schedule 2 of this Agreement, and shall bring out clearly the organization structure, time plan and methodology for executing the Project, award of major contracts, designing, engineering, procurement, shipping, construction, testing and commissioning to commercial operation;
- d. To submit to the Nodal Agency, CEA & Independent Engineer a detailed bar (GANTT) chart of the Project outlining each activity (taking longer than one Month), linkages as well as durations;
- e. To submit to the Nodal Agency, CEA & Independent Engineer detailed specifications of conductor meeting the functional specifications specified in RFP;
- f. To achieve Financial Closure;
- g. To provide an irrevocable letter to the Lenders duly accepting and acknowledging the rights provided to the Lenders under the provisions of Article 15.3 of this Agreement and all other RFP Project Documents;
- h. To award the Engineering, Procurement and Construction contract ("EPC contract") for the design and construction of the Project and shall have given to such Contractor an irrevocable notice to proceed; and
- i. To sign the Agreement(s) required, if any, under Sharing Regulations.

3.2 Recognition of Lenders' Rights by the Nodal Agency

- 3.2.1 The Nodal Agency hereby accepts and acknowledges the rights provided to the Lenders as per Article 15.3 of this Agreement and all other RFP Project Documents.

3.3 Consequences of non-fulfilment of conditions subsequent

3.3.1 If any of the conditions specified in Article 3.1.3 is not duly fulfilled by the TSP even within three (3) Months after the time specified therein, then on and from the expiry of such period and until the TSP has satisfied all the conditions specified in Article 3.1.3, the TSP shall, on a monthly basis, be liable to furnish to Central Transmission Utility of India Limited (being the Nodal Agency) additional Contract Performance Guarantee of Rupees Thirteen Crore Ninety Five Lakh Only (Rs. 13.95 Crore) within two (2) Business Days of expiry of every such Month. Such additional Contract Performance Guarantee shall be provided to Central Transmission Utility of India Limited (being the Nodal Agency) in the manner provided in Article 3.1.1 and shall become part of the Contract Performance Guarantee and all the provisions of this Agreement shall be construed accordingly. Central Transmission Utility of India Limited (being the Nodal Agency) shall be entitled to hold and / or invoke the Contract Performance Guarantee, including such additional Contract Performance Guarantee, in accordance with the provisions of this Agreement.

3.3.2 Subject to Article 3.3.4, if:

- (i) the fulfilment of any of the conditions specified in Article 3.1.3 is delayed beyond nine (9) Months from the Effective Date and the TSP fails to furnish additional Contract Performance Guarantee to the Nodal Agency in accordance with Article 3.3.1 hereof; or
- (ii) the TSP furnishes additional Performance Guarantee to the Nodal Agency in accordance with Article 3.3.1 hereof but fails to fulfil the conditions specified in Article 3.1.3 within a period of twelve (12) months from the Effective Date,

the Nodal Agency shall have the right to terminate this Agreement, by giving a Termination Notice to the TSP, in writing, of at least seven (7) days, with a copy to CEA and the Lenders' Representative in order to enable the Lenders to exercise right of substitution in accordance with Article 15.3 of this Agreement.

3.3.3 If the Nodal Agency elects to terminate this Agreement as per the provisions of Article 3.3.2, the TSP shall be liable to pay to the Nodal Agency an amount of Rs. 139.50 Crore (Rupees One Hundred Thirty Nine Crore Fifty Lakh only) as liquidated damages. The Nodal Agency shall be entitled to recover this amount of damages by invoking the Contract Performance Guarantee to the extent of liquidated damages, which shall be required by the Nodal Agency, and the balance shall be returned to TSP, if any.

It is clarified for removal of doubt that this Article shall survive the termination

of this Agreement.

- 3.3.4 In case of inability of the TSP to fulfil the conditions specified in Article 3.1.3 due to any Force Majeure Event, the time period for fulfilment of the condition subsequent as mentioned in Article 3.1.3, may be extended for a period of such Force Majeure Event. Alternatively, if deemed necessary, this Agreement may be terminated by the Nodal Agency by giving a Termination Notice to the TSP, in writing, of at least seven (7) days, with a copy to CEA and the Lenders' Representative in order to enable the Lenders to exercise right of substitution in accordance with Article 15.3 of this Agreement and the Contract Performance Guarantee shall be returned as per the provisions of Article 6.5.1.

Provided, that due to the provisions of this Article 3.3.4, any increase in the time period for completion of conditions subsequent mentioned under Article 3.1.3, shall lead to an equal increase in the time period for the Scheduled COD. If the Scheduled COD is extended beyond a period of one hundred eighty (180) days due to the provisions of this Article 3.3.4, the TSP will be allowed to recover the interest cost during construction corresponding to the period exceeding one hundred eighty (180) days by adjustment in the Transmission Charges in accordance with Schedule 9.

- 3.3.5 Upon termination of this Agreement as per Articles 3.3.2 and 3.3.4, the Nodal Agency may take steps to bid out the Project again.
- 3.3.6 The Nodal agency, on the failure of the TSP to fulfil its obligations, if it considers that there are sufficient grounds for so doing, apart from invoking the Contract Performance Guarantee under para 3.3.3 may also initiate proceedings for blacklisting the TSP as per provisions of Article 13.2 of TSA.

3.4 Progress Reports

The TSP shall notify the Nodal Agency and CEA in writing at least once a Month on the progress made in satisfying the conditions subsequent in Articles 3.1.3.

ARTICLE: 4

4 DEVELOPMENT OF THE PROJECT

4.1 TSP's obligations in development of the Project:

Subject to the terms and conditions of this Agreement, the TSP at its own cost and expense shall observe, comply with, perform, undertake and be responsible:

- a. for procuring and maintaining in full force and effect all Consents, Clearances and Permits, required in accordance with Law for development of the Project;
- b. for financing, constructing, owning and commissioning each of the Element of the Project for the scope of work set out in Schedule 1 of this Agreement in accordance with:
 - i. the Electricity Act and the Rules made thereof;
 - ii. the Grid Code;
 - iii. the CEA Regulations applicable, and as amended from time to time, for Transmission Lines and sub-stations:
 - the Central Electricity Authority (Technical Standards for Connectivity to the Grid) Regulations, 2007;
 - Central Electricity Authority (Technical Standards for construction of Electrical Plants and Electric Lines) Regulation, 2010;
 - Central Electricity Authority (Grid Standard) Regulations, 2010;
 - Central Electricity Authority (Safety requirements for construction, operation and maintenance of Electrical Plants and Electrical Lines) Regulation, 2011;
 - Central Electricity Authority (Measures relating to Safety and Electricity Supply) Regulation, 2010;
 - Central Electricity Authority (Technical Standards for Communication System in Power System Operation) Regulations, 2020.
 - iv. Safety/ security Guidelines laid down by the Government;
 - v. Prudent Utility Practices, relevant Indian Standards and the Law;

Transmission Service Agreement

not later than the Scheduled COD as per Schedule 2 of this Agreement;

- c. for entering into a Connection Agreement with the concerned parties in accordance with the Grid Code.
- d. for owning the Project throughout the term of this Agreement free and clear of any encumbrances except those expressly permitted under Article 15 of this Agreement;
- e. to co-ordinate and liaise with concerned agencies and provide on a timely basis relevant information with regard to the specifications of the Project that may be required for interconnecting the Project with the Interconnection Facilities;
- f. for providing all assistance to the Arbitrators as they may require for the performance of their duties and responsibilities;
- g. to provide to the Nodal Agency and CEA, on a monthly basis, progress reports with regard to the Project and its execution (in accordance with prescribed form) to enable the CEA to monitor and co-ordinate the development of the Project matching with the Interconnection Facilities;
- h. to comply with Ministry of Power order no. 25-11/6/2018 – PG dated 02.07.2020 as well as other Guidelines issued by Govt. of India pertaining to this;
- i. to procure the products associated with the Transmission System as per provisions of Public Procurement (Preference to Make in India) orders issued by Ministry of Power vide orders No. 11/5/2018 - Coord. dated 28.07.2020 for transmission sector, as amended from time to time read with Department for Promotion of Industry and Internal Trade (DPIIT) orders in this regard (Procuring Entity as defined in above orders shall deemed to have included Selected Bidder and/ or TSP).

Also, to comply with Department of Expenditure, Ministry of Finance vide Order (Public Procurement No 1) bearing File No. 6/18/2019-PPD dated 23.07.2020, Order (Public Procurement No 2) bearing File No. 6/18/2019-PPD dated 23.07.2020 and Order (Public Procurement No. 3) bearing File No. 6/18/2019-PPD, dated 24.07.2020, as amended from time to time, regarding public procurement from a bidder of a country, which shares land border with India;

- j. to submit to Nodal Agency information in the prescribed format [To be devised by Nodal Agency] for ensuring compliance to Article 4.1 i) above.
- k. to comply with all its obligations undertaken in this Agreement.

4.2 Roles of the Nodal Agency in implementation of the Project:

4.2.1 Subject to the terms and conditions of this Agreement, the Nodal Agency shall be the holder and administrator of this Agreement and shall inter alia:

- a. appoint an Independent Engineer within 90 days of the Effective Date
- b. provide letters of recommendation to the concerned Indian Governmental Instrumentality, as may be requested by the TSP from time to time, for obtaining the Consents, Clearances and Permits required for the Project;
- c. coordinate among TSP and upstream/downstream entities in respect of Interconnection Facilities; and
- d. monitor the implementation of the Agreement and take appropriate action for breach thereof including revocation of guarantees, cancellation of Agreement, blacklisting etc
- e. provide all assistance to the Arbitrators as required for the performance of their duties and responsibilities; and
- f. perform any other responsibility (ies) as specified in this Agreement.

4.3 Time for Commencement and Completion:

- a. The TSP shall take all necessary steps to commence work on the Project from the Effective Date of the Agreement and shall achieve Scheduled COD of the Project in accordance with the time schedule specified in Schedule 2 of this Agreement;
- b. The COD of each Element of the Project shall occur no later than the Scheduled COD or within such extended time to which the TSP shall be entitled under Article 4.4 hereto.

4.4 Extension of time:

4.4.1 In the event that the TSP is unable to perform its obligations for the reasons solely attributable to the Nodal Agency, the Scheduled COD shall be extended, by a 'day to day' basis, subject to the provisions of Article 13.

4.4.2 In the event that an Element or the Project cannot be commissioned by its Scheduled COD on account of any Force Majeure Event as per Article 11, the Scheduled COD shall be extended, by a 'day to day' basis for a period of such Force Majeure Event. Alternatively, if deemed necessary, the Nodal Agency may terminate the Agreement as per the provisions of Article 13.4 by giving a Termination Notice to the TSP, in writing, of at least seven (7) days, with a copy to CEA and the Lenders' Representative in order to enable the Lenders to exercise right of substitution in accordance with Article 15.3 of this Agreement.

4.4.3 If the Parties have not agreed, within thirty (30) days after the affected Party's performance has ceased to be affected by the relevant circumstance, on how long the Scheduled COD should be deferred by, any Party may raise the Dispute to be resolved in accordance with Article 16.

4.5 Metering Arrangements:

4.5.1 The TSP shall comply with all the provisions of the IEGC and the Central Electricity Authority (Installation and Operation of Meters) Regulations, 2006 as amended from time to time, with regard to the metering arrangements for the Project. The TSP shall fully cooperate with the CTU / STU / RLDC and extend all necessary assistance in taking meter readings.

4.6 Interconnection Facilities:

4.6.1 Subject to the terms and conditions of this Agreement, the TSP shall be responsible for connecting the Project with the interconnection point(s) specified in Schedule 1 of this Agreement. The Interconnection Facilities shall be developed as per the scope of work and responsibilities assigned in Schedule 1 of this Agreement. The Nodal Agency shall be responsible for coordinating to make available the Interconnection Facilities.

4.6.2 In order to remove any doubts, it is made clear that the obligation of the TSP within the scope of the project is to construct the Project as per Schedule-1 of this Agreement and in particular to connect it to the Interconnection Facilities as specified in this Agreement.

ARTICLE: 5

5 CONSTRUCTION OF THE PROJECT

5.1 TSP's Construction Responsibilities:

- 5.1.1 The TSP, at its own cost and expense, shall be responsible for designing, constructing, erecting, testing and commissioning each Element of the Project by the Scheduled COD in accordance with the Regulations and other applicable Laws specified in Article 4.1 of this Agreement.
- 5.1.2 The TSP acknowledges and agrees that it shall not be relieved from any of its obligations under this Agreement or be entitled to any extension of time or any compensation whatsoever by reason of the unsuitability of the Site or Transmission Line route(s).
- 5.1.3 The TSP shall be responsible for obtaining all Consents, Clearances and Permits related but not limited to road / rail / river / canal / power line / crossings, Power and Telecom Coordination Committee (PTCC), defence, civil aviation, right of way / way-leaves and environmental & forest clearances from relevant authorities required for developing, financing, constructing, maintaining/renewing all such Consents, Clearances and Permits in order to carry out its obligations under this Agreement in general and shall furnish to the Nodal Agency such copy/ies of each Consents, Clearances and Permits, on demand. Nodal Agency shall provide letters of recommendation to the concerned Indian Governmental Instrumentality, as may be requested by the TSP from time to time, for obtaining the Consents, Clearances and Permits required for the Project.
- 5.1.4 The TSP shall be responsible for:
- (a) acquisition of land for location specific substations, switching stations or HVDC terminal or inverter stations. Also, the actual location of Greenfield substations (Switching Stations or HVDC Terminal or Inverter Stations) for a generation pooling substation and for load serving substations in the scope of TSP shall not be beyond 3 Km radius of the location proposed by the BPC in the survey report. However, actual location of any Greenfield Intermediate Substations in the scope of TSP shall not be beyond 10 Km radius of the location proposed by the BPC in the Survey Report;
 - (b) final selection of Site including its geo-technical investigation;

- (c) survey and geo-technical investigation of line route in order to determine the final route of the Transmission Lines;
- (d) seeking access to the Site and other places where the Project is being executed, at its own risk and costs, including payment of any crop, tree compensation or any other compensation as may be required.

5.1.5 In case the Project involves any resettlement and rehabilitation, the resettlement and rehabilitation package will be implemented by the State Government authorities, for which the costs is to be borne by the TSP and no changes would be allowed in the Transmission Charges on account of any variation in the resettlement and rehabilitation cost. The TSP shall provide assistance on best endeavour basis, in implementation of the resettlement and rehabilitation package, if execution of such package is in the interest of expeditious implementation of the Project and is beneficial to the Project affected persons.

5.2 Appointing Contractors:

- 5.2.1 The TSP shall conform to the requirements as provided in this Agreement while appointing Contractor(s) for procurement of goods & services.
- 5.2.2 The appointment of such Contractor(s) shall neither relieve the TSP of any of its obligations under this Agreement nor make the Nodal Agency liable for the performance of such Contractor(s).

5.3 Monthly Progress Reporting:

The TSP shall provide to the CEA, Nodal Agency & Independent Engineer, on a monthly basis, progress reports along with likely completion date of each Element with regard to the Project and its execution (in accordance with prescribed form). The Nodal Agency/ CEA shall monitor the development of the Project for its timely completion for improving and augmenting the electricity system as a part of its statutory responsibility.

5.4 Quality of Workmanship:

The TSP shall ensure that the Project is designed, built and completed in a good workmanship using sound engineering and construction practices, and using only materials and equipment that are new and manufactured as per the MQP and following approved FQP for erection, testing & commissioning and complying with Indian /International Standards such that, the useful life of the Project will be at least thirty five (35) years from the COD of the Project.

The TSP shall ensure that all major substation equipment / component (e.g. transformers, reactors, Circuit Breakers, Instrument Transformers (IT), Surge

Arresters (SA), Protection relays, clamps & connectors etc.), equipment in terminal stations of HVDC installations including Thyristor/ IGBT valves, Converter Transformers, smoothing reactors, Transformer bushings and wall bushings, GIS bus ducts, towers and gantry structures and transmission towers or poles and line materials (conductors, earthwire, OPGW, insulator, accessories for conductors, OPGW & earthwires, hardware fittings for insulators, aviation lights etc), facilities and system shall be designed, constructed and tested (Type test, Routine tests, Factory Acceptance Test (FAT)) in accordance with relevant CEA Regulations and Indian Standards. In case Indian Standards for any particular equipment/ system/ process is not available, IEC/ IEEE or equivalent International Standards and Codes shall be followed.

5.5 Progress Monitoring & Quality Assurance:

5.5.1 The Project Execution Plan submitted by the TSP in accordance with Article 3.1.3 c) shall comprise of detailed schedule of all the equipments/items /materials required for the Project, right from procurement of raw material till the dispatch from works and receipt at the site. Further, it should also include various stages of the construction schedule up to the commissioning of the Project.

5.5.2 Nodal Agency, CEA & Independent Engineer shall have access at all reasonable times to the Site and to the Manufacturer's works and to all such places where the Project is being executed.

5.5.3 Independent Engineer shall ensure conformity of the conductor specifications with the functional specifications specified in RFP.

5.5.4 The Independent Engineer shall monitor the following during construction of the Project:

- a) Quality of equipments, material, foundation, structures and workmanship etc. as laid down in Article 5.4 and 6.1.4 of the TSA. Specifically, quality of Sub-station equipments, transmission line material and workmanship etc. would be checked in accordance with the Article 5.4.
- b) Progress in the activities specified in Condition Subsequent
- c) Verification of readiness of the elements including the statutory clearances & completion of civil works, fixing of all components and finalisation of punch points (if any) prior to charging of the elements
- d) Progress of construction of substation and Transmission Lines

- 5.5.5 The progress shall be reviewed by the Independent Engineer against the Project Execution Plan. The Independent Engineer shall prepare its report on monthly basis and submit the same to Nodal Agency highlighting the progress achieved till the end of respective month vis-à-vis milestone activities, areas of concern, if any, which may result in delay in the timely completion of the Project. Based on the progress, Nodal Agency and/ or CEA shall issue written instructions to the TSP to take corrective measures, as may be prudent for the timely completion of the Project. In case of any deficiency, the Nodal Agency would be at liberty to take action in accordance with the procedure of this Agreement.
- 5.5.6 For any delay in commissioning any critical Element(s), as identified in Schedule 1 & Schedule 2 of this Agreement, beyond a period of 45 days shall lead to a sequestration of 10% of the Contract Performance Guarantee.

5.6 Site regulations and Construction Documents

The TSP shall abide by the Safety Rules and Procedures as mentioned in Schedule 3 of this Agreement

The TSP shall retain at the Site and make available for inspection at all reasonable times, copies of the Consents, Clearances and Permits, construction drawings and other documents related to construction.

5.7 Supervision of work:

The TSP shall provide all necessary superintendence for execution of the Project and its supervisory personnel shall be available to provide full-time superintendence for execution of the Project. The TSP shall provide skilled personnel who are experienced in their respective fields.

5.8 Remedial Measures:

The TSP shall take all necessary actions for remedying the shortfall in achievement of timely progress in execution of the Project, if any, as intimated by the Independent Engineer and/ or CEA and/ or the Nodal Agency. However, such intimation by the Independent Engineer and/ or CEA and/ or the Nodal Agency and the subsequent effect of such remedial measures carried out by the TSP shall not relieve the TSP of its obligations in the Agreement. Independent Engineer and/ or CEA and/ or the Nodal Agency may carry out random inspections during the Project execution, as and when deemed necessary by it. If the shortfalls as intimated to the TSP are not remedied to the satisfaction of the CEA and/ or the Nodal Agency, this Agreement may be terminated by the Nodal Agency by giving a Termination Notice to the TSP, in writing, of at least seven (7) days, with a copy to CEA and the Lenders' Representative in order to enable the

Transmission Service Agreement

Lenders to exercise right of substitution in accordance with Article 15.3 of this Agreement.

ARTICLE: 6

6 CONNECTION AND COMMISSIONING OF THE PROJECT

6.1 Connection with the Inter-Connection Facilities:

- 6.1.1 The TSP shall give the RLDC(s), CTU, / STU, as the case may be, and any other agencies as required, at least sixty (60) days advance written notice of the date on which it intends to connect an Element of the Project, which date shall not be earlier than its Scheduled COD or Schedule COD extended as per Article 4.4.1 & 4.4.2 of this Agreement, unless mutually agreed to by Parties. Further, any preponing of COD of any element prior to Scheduled COD must be approved by the Nodal Agency.
- 6.1.2 The RLDC / SLDC (as the case may be) or the CTU / STU (as the case may be), for reasonable cause, including non-availability of Interconnection Facilities as per Article 4.2, can defer the connection for up to fifteen (15) days from the date notified by the TSP pursuant to Article 6.1.1, if it notifies to the TSP in writing, before the date of connection, of the reason for the deferral and when the connection is to be rescheduled. However, no such deferment on one or more occasions would be for more than an aggregate period of thirty (30) days. Further, the Scheduled COD would be extended as required, for all such deferments on “day to day” basis.
- 6.1.3 Subject to Articles 6.1.1 and 6.1.2, any Element of Project may be connected with the Interconnection Facilities when:
- a. it has been completed in accordance with this Agreement and the Connection Agreement;
 - b. it meets the Grid Code, Central Electricity Authority (Technical Standards for Connectivity to the Grid) Regulations, 2007 as amended from time to time and all other Indian legal requirements, and
 - c. The TSP has obtained the approval in writing of the Electrical Inspector certifying that the Element is ready from the point of view of safety of supply and can be connected with the Interconnection Facilities.
 - d. It has satisfactorily met all the testing requirements as per Articles 6.1.4.

6.1.4 Site Acceptance Test (SAT)/ pre-commissioning tests of all major substation equipment, component, system, facilities shall be successfully carried out before commissioning. The Type tests, FAT and SAT reports should be available at the substation / terminal station of HVDC installations for ready reference of operation and maintenance staff and has to be made available to the Independent Engineer appointed for quality monitoring or their authorised representatives, as and when they wish to examine the same.

6.2 Commercial Operation:

6.2.1 An Element of the Project shall be declared to have achieved COD twenty four (24) hours following the connection of the Element with the Interconnection Facilities pursuant to Article 6.1 or seven (7) days after the date on which it is declared by the TSP to be ready for charging but is not able to be charged for reasons not attributable to the TSP subject to Article 6.1.2.

Provided that an Element shall be declared to have achieved COD only after all the Element(s), if any, which are pre-required to have achieved COD as defined in Schedule 2 of this Agreement, have been declared to have achieved their respective COD.

6.2.2 Once any Element of the Project has been declared to have achieved deemed COD as per Article 6.2.1 above, such Element of the Project shall be deemed to have Availability equal to the Target Availability till the actual charging of the Element and to this extent, TSP shall be eligible for the Monthly Transmission Charges applicable for such Element

6.3 Compensation for Direct Non Natural Force Majeure Event or Indirect Non Natural Force Majeure Event or Natural Force Majeure Event (affecting the Nodal Agency)

6.3.1 If the TSP is otherwise ready to connect the Element(s) of the Project and has given due notice, as per provisions of Article 6.1.1, to the concerned agencies of the date of intention to connect the Element(s) of the Project, where such date is not before the Scheduled COD, but is not able to connect the Element(s) of the Project by the said date specified in the notice, due to Direct Non Natural Force Majeure Event or Indirect Non Natural Force Majeure Event or Natural Force Majeure Event affecting the Nodal Agency, provided such Direct Non Natural Force Majeure Event or Indirect Non Natural Force Majeure Event or Natural Force Majeure Event affecting the Nodal Agency has continued for a period of more than three (3) continuous or non-continuous Months, the TSP shall, until the effects of the Direct Non Natural Force Majeure Event or of Indirect Non Natural Force Majeure Event or Natural Force Majeure Event affecting the

Nodal Agency no longer prevent the TSP from connecting the Element(s) of the Project, be deemed to have achieved COD relevant to that date and to this extent, be deemed to have been providing Transmission Service with effect from the date notified, and shall be treated as follows:

- a. In case of delay due to Direct Non Natural Force Majeure Event, TSP is entitled for Transmission Charges calculated on Target Availability for the period of such events in excess of three (3) continuous or non continuous Months in the manner provided in (c) below.
- b. In case of delay due to Indirect Non Natural Force Majeure Event or Natural Force Majeure Event affecting the Nodal Agency, TSP is entitled for payment for debt service which is due under the Financing Agreements, subject to a maximum of Transmission Charges calculated on Target Availability, for the period of such events in excess of three (3) continuous or non continuous Months in the manner provided in (c) below.
- c. In case of delay due to Direct Non Natural Force Majeure Event or Indirect Non Natural Force Majeure Event or Natural Force Majeure Event affecting the Nodal Agency, the TSP is entitled for payments mentioned in (a) and (b) above, after commencement of Transmission Service, in the form of an increase in Transmission Charges. These amounts shall be paid from the date, being the later of a) the date of cessation of such Indirect Non Natural Force Majeure Event or Natural Force Majeure Event affecting the Nodal Agency and b) the completion of sixty (60) days from the receipt of the Financing Agreements by the Nodal Agency from the TSP.

Provided such increase in Transmission Charges shall be so as to put the TSP in the same economic position as the TSP would have been in case the TSP had been paid amounts mentioned in (a) and (b) above in a situation where the Force Majeure Event had not occurred.

For the avoidance of doubt, it is clarified that the charges payable under this Article 6.3.1 shall be recovered as per Sharing Regulations.

6.4 Liquidated Damages for Delay in achieving COD of Project:

- 6.4.1 If the TSP fails to achieve COD of any Element of the Project or the Project, by the Element's / Project's Scheduled COD or such Scheduled COD as extended under Articles 4.4.1 and 4.4.3, then the TSP shall pay to the Nodal Agency, a sum equivalent to 3.33% of Monthly Transmission Charges applicable for the Element of the Project [in case where no Elements have been defined, to be on

the Project as a whole] / Project, for each day of delay up to sixty (60) days of delay and beyond that time limit, at the rate of five percent (5%) of the Monthly Transmission Charges applicable to such Element / Project, as liquidated damages for such delay and not as penalty, without prejudice to any rights of the Nodal Agency under the Agreement.

- 6.4.2 The TSP's maximum liability under this Article 6.4 shall be limited to the amount of liquidated damages calculated in accordance with Article 6.4.1 for and up to six (6) months of delay for the Element or the Project.

Provided that, in case of failure of the TSP to achieve COD of the Element of the Project even after the expiry of six (6) months from its Scheduled COD, the provisions of Article 13 shall apply.

- 6.4.3 The TSP shall make payment to the Nodal Agency of the liquidated damages calculated pursuant to Article 6.4.1 within ten (10) days of the earlier of:
- a. the date on which the applicable Element achieves COD; or
 - b. the date of termination of this Agreement.

The payment of such damages shall not relieve the TSP from its obligations to complete the Project or from any other obligation and liabilities under the Agreement.

- 6.4.4 If the TSP fails to pay the amount of liquidated damages to the Nodal Agency within the said period of ten (10) days, the Nodal Agency shall be entitled to recover the said amount of the liquidated damages by invoking the Contract Performance Guarantee. If the then existing Contract Performance Guarantee is for an amount which is less than the amount of the liquidated damages payable by the TSP to the Nodal Agency under this Article 6.3 and the TSP fails to make payment of the balance amount of the liquidated damages not covered by the Contract Performance Guarantee, then such balance amount shall be deducted from the Transmission Charges payable to the TSP. The right of the Nodal Agency to encash the Contract Performance Guarantee is without prejudice to the other rights of the Nodal Agency under this Agreement.

- 6.4.5 For avoidance of doubt, it is clarified that amount payable by TSP under this Article is over and above the penalty payable by TSP under Article 5.5.6 of this Agreement.

6.5 Return of Contract Performance Guarantee

- 6.5.1 The Contract Performance Guarantee as submitted by TSP in accordance with Article 3.1.1 shall be released by the Nodal Agency within three (3) months

from the COD of the Project. In the event of delay in achieving Scheduled COD of any of the Elements by the TSP (otherwise than due to reasons as mentioned in Article 3.1.3 or Article 11) and consequent part invocation of the Contract Performance Guarantee by the Nodal Agency, Nodal Agency shall release the Contract Performance Guarantee, if any remaining unadjusted, after the satisfactory completion by the TSP of all the requirements regarding achieving the Scheduled COD of the remaining Elements of the Project. It is clarified that the Nodal Agency shall also return / release the Contract Performance Guarantee in the event of (i) applicability of Article 3.3.2 to the extent the Contract Performance Guarantee is valid for an amount in excess of Rs. 139.50 Crore (Rupees One hundred Thirty Nine Crore Fifty Lakh only), or (ii) termination of this Agreement by the Nodal Agency as mentioned under Article 3.3.4 of this Agreement.

- 6.5.2 The release of the Contract Performance Guarantee shall be without prejudice to other rights of the Nodal Agency under this Agreement.

ARTICLE: 7

7 OPERATION AND MAINTENANCE OF THE PROJECT

7.1 Operation and Maintenance of the Project:

The TSP shall be responsible for ensuring that the Project is operated and maintained in accordance with the regulations made by the Commission and CEA from time to time and provisions of the Act.

ARTICLE: 8

8 AVAILABILITY OF THE PROJECT

8.1 Calculation of Availability of the Project:

Calculation of Availability for the Elements and for the Project, as the case may be, shall be as per Appendix –IV to Central Electricity Regulatory Commission (Terms and Conditions of Tariff) Regulations, 2024, as applicable on the Bid Deadline and as appended in Schedule 6 of this Agreement.

8.2 Target Availability:

The Target Availability of each Element and the Project shall be 98%.

Payment of monthly Transmission charges based on actual availability will be calculated as per para 1.2 of Schedule 4 of this Agreement.

If the availability of any Element or the Project is below the Target Availability, for six consecutive months in a Contract Year, the DIC(s) or the Nodal Agency may issue a show cause notice to the TSP, asking them to show cause as to why the Transmission Service Agreement be not terminated, and if no satisfactory cause is shown it may terminate the Agreement. If the Nodal Agency is of the opinion that the transmission system is of critical importance, it may carry out or cause to carry the operation and maintenance of transmission system at the risk and cost of TSP.

ARTICLE: 9

9 INSURANCES

9.1 Insurance:

9.1.1 The TSP shall effect and maintain or cause to be effected and maintained during the Construction Period and the Operating Period, adequate Insurances against such risks, with such deductibles including but not limited to any third party liability and endorsements and co-beneficiary/insured, as may be necessary under

- a. any of the Financing Agreements,
- b. the Laws, and
- c. in accordance with Prudent Utility Practices.

The Insurances shall be taken effective from a date prior to the date of the Financial Closure till the Expiry Date.

9.2 Evidence of Insurance cover:

9.2.1 The TSP shall furnish to the Nodal Agency copies of certificates and policies of the Insurances, as and when the Nodal Agency may seek from the TSP as per the terms of Article 9.1

9.3 Application of Insurance Proceeds:

9.3.1 Save as expressly provided in this Agreement, the policies of Insurances and the Financing Agreements, the proceeds of any insurance claim made due to loss or damage to the Project or any part of the Project shall be first applied to reinstatement, replacement or renewal of such loss or damage.

9.3.2 If a Natural Force Majeure Event renders the Project no longer economically and technically viable and the insurers under the Insurances make payment on a “total loss” or equivalent basis, the portion of the proceeds of such Insurance available to the TSP (after making admissible payments to the Lenders as per the Financing Agreements) shall be allocated only to the TSP. Nodal Agency and / or concerned Designated ISTS Customers shall have no claim on such proceeds of the Insurance.

9.3.3 Subject to the requirements of the Lenders under the Financing Agreements, any dispute or difference between the Parties as to whether the Project is no longer economically and technically viable due to a Force Majeure Event or whether that event was adequately covered in accordance with this Agreement by the Insurances shall be determined in accordance with Article 16.

9.4 Effect on liability of the Nodal Agency / Designated ISTS Customers

9.4.1 The Nodal Agency and / or the Designated ISTS Customers shall have no financial obligations or liability whatsoever towards the TSP in respect of this Article 9.

ARTICLE: 10

10 BILLING AND PAYMENT OF TRANSMISSION CHARGES

10.1 Subject to provisions of this Article 10, the Monthly Transmission Charges shall be paid to the TSP, in Indian Rupees, on monthly basis as per the provisions of the Sharing Regulations, from the date on which an Element(s) has achieved COD until the Expiry Date of this Agreement, unless terminated earlier and in line with the provisions of Schedule 4 of this Agreement.

10.2 Calculation of Monthly Transmission Charges:

The Monthly Transmission Charges for each Contract Year including Incentive & Penalty payment shall be calculated in accordance with the provisions of Schedule 4 of this Agreement.

10.3 Rebate & Late Payment Surcharge:

The rebate and late payment surcharge shall be governed as per Sharing Regulations.

10.4 Disputed Bills, Default in payment by the Designated ISTS Customers & Annual Reconciliation:

Any Disputed Bill, Default in payment by the Designated ISTS Customers & Annual Reconciliation shall be governed as per Sharing Regulations.

ARTICLE: 11

11 FORCE MAJEURE

11.1 Definitions

11.1.1 The following terms shall have the meanings given hereunder.

11.2 Affected Party

11.2.1 An Affected Party means any Party whose performance has been affected by an event of Force Majeure.

11.2.2 Any event of Force Majeure shall be deemed to be an event of Force Majeure affecting the TSP only if the Force Majeure event affects and results in, late delivery of machinery and equipment for the Project or construction, completion, commissioning of the Project by Scheduled COD and/or operation thereafter;

11.3 Force Majeure

A 'Force Majeure' means any event or circumstance or combination of events and circumstances including those stated below that wholly or partly prevents or unavoidably delays an Affected Party in the performance of its obligations/ roles under this Agreement, but only if and to the extent that such events or circumstances are not within the reasonable control, directly or indirectly, of the Affected Party and could not have been avoided if the Affected Party had taken reasonable care or complied with Prudent Utility Practices:

(a) Natural Force Majeure Events:

- i. act of God, including, but not limited to drought, fire and explosion (to the extent originating from a source external to the Site), earthquake, volcanic eruption, landslide, flood, cyclone, typhoon, tornado, or exceptionally adverse weather conditions, which are in excess of the statistical measures for the last hundred (100) years; and
- ii. epidemic/ pandemic notified by Indian Governmental Instrumentality.

(b) Non-Natural Force Majeure Events :

- i. Direct Non-Natural Force Majeure Events

- Nationalization or compulsory acquisition by any Indian Governmental Instrumentality of any material assets or rights of the Affected Party; or
 - the unlawful, unreasonable or discriminatory revocation of, or refusal to renew, any Consents, Clearances and Permits required by the Affected Party to perform their obligations/ roles under the RFP Project Documents or any unlawful, unreasonable or discriminatory refusal to grant any other Consents, Clearances and Permits required for the development/ operation of the Project, provided that a Competent Court of Law declares the revocation or refusal to be unlawful, unreasonable and discriminatory and strikes the same down; or
 - any other unlawful, unreasonable or discriminatory action on the part of an Indian Governmental Instrumentality which is directed against the Project, provided that a Competent Court of Law declares the action to be unlawful, unreasonable and discriminatory and strikes the same down.
- ii. Indirect Non - Natural Force Majeure Events
- act of war (whether declared or undeclared), invasion, armed conflict or act of foreign enemy, blockade, embargo, revolution, riot, insurrection, terrorist or military action; or
 - radio active contamination or ionising radiation originating from a source in India or resulting from any other Indirect Non Natural Force Majeure Event mentioned above, excluding circumstances where the source or cause of contamination or radiation is brought or has been brought into or near the Site by the Affected Party or those employed or engaged by the Affected Party; or
 - industry-wide strikes and labour disturbances, having a nationwide impact in India.

11.4 Force Majeure Exclusions

11.4.1 Force Majeure shall not include (i) any event or circumstance which is within the reasonable control of the Parties and (ii) the following conditions, except to the extent that they are consequences of an event of Force Majeure:

- (a) Unavailability, late delivery, or changes in cost of the machinery, equipment, materials, spare parts etc. for the Project;

- (b) Delay in the performance of any Contractors or their agents;
- (c) Non-performance resulting from normal wear and tear typically experienced in transmission materials and equipment;
- (d) Strikes or labour disturbance at the facilities of the Affected Party;
- (e) Insufficiency of finances or funds or the Agreement becoming onerous to perform; and
- (f) Non-performance caused by, or connected with, the Affected Party's:
 - i. negligent or intentional acts, errors or omissions;
 - ii. failure to comply with an Indian Law; or
 - iii. breach of, or default under this Agreement or any Project Documents.
- (g) Any error or omission in the survey report provided by BPC during the bidding process.

11.5 Notification of Force Majeure Event

11.5.1 The Affected Party shall give notice to the other Party of any event of Force Majeure as soon as reasonably practicable, but not later than seven (7) days after the date on which such Party knew or should reasonably have known of the commencement of the event of Force Majeure. If an event of Force Majeure results in a breakdown of communications rendering it unreasonable to give notice within the applicable time limit specified herein, then the Party claiming Force Majeure shall give such notice as soon as reasonably practicable after reinstatement of communications, but not later than one (1) day after such reinstatement.

Provided that, such notice shall be a pre-condition to the Affected Party's entitlement to claim relief under this Agreement. Such notice shall include full particulars of the event of Force Majeure, its effects on the Party claiming relief and the remedial measures proposed. The Affected Party shall give the other Party regular reports on the progress of those remedial measures and such other information as the other Party may reasonably request about the Force Majeure.

11.5.2 The Affected Party shall give notice to the other Party of (i) the cessation of the relevant event of Force Majeure; and (ii) the cessation of the effects of such event of Force Majeure on the performance of its rights or obligations/ roles under this Agreement, as soon as practicable after becoming aware of each of

these cessations.

11.6 Duty to perform and duty to mitigate

To the extent not prevented by a Force Majeure Event, the Affected Party shall continue to perform its obligations/ roles as provided in this Agreement. The Affected Party shall use its reasonable efforts to mitigate the effect of any event of Force Majeure as soon as practicable.

11.7 Available Relief for a Force Majeure Event

Subject to this Article 11,

- (a) no Party shall be in breach of its obligations/ roles pursuant to this Agreement to the extent that the performance of its obligations/ roles was prevented, hindered or delayed due to a Force Majeure Event;
- (b) each Party shall be entitled to claim relief for a Force Majeure Event affecting its performance in relation to its obligations/ roles under Articles 3.3.4, 4.4.2 and 6.3.1 of this Agreement.
- (c) For the avoidance of doubt, it is clarified that the computation of Availability of the Element(s) under outage due to Force Majeure Event, as per Article 11.3 affecting the TSP shall be as per Appendix –IV to Central Electricity Regulatory Commission (Terms and Conditions of Tariff) Regulations, 2024 as on Bid Deadline. For the event(s) for which the Element(s) is/are deemed to be available as per Appendix –IV to Central Electricity Regulatory Commission (Terms and Conditions of Tariff) Regulations, 2024, then the Transmission Charges, as applicable to such Element(s), shall be payable as per Schedule 4, for the duration of such event(s).
- (d) For so long as the TSP is claiming relief due to any Force Majeure Event under this Agreement, the Nodal Agency may, if it so desires, from time to time on one (1) day notice, inspect the Project and the TSP shall provide the Nodal Agency's personnel with access to the Project to carry out such inspections.
- (e) For avoidance of doubt, the TSP acknowledges that for extension of Scheduled COD a period up to one hundred eighty (180) days due to Force Majeure event, no compensation on the grounds such as interest cost, incident expenditure, opportunity cost will be made to the TSP. However, if Scheduled COD is extended beyond a period of one hundred eighty (180) days due to Force Majeure event, the TSP will be allowed to recover the

Transmission Service Agreement

interest cost during construction corresponding to the period exceeding one hundred eighty (180) days by adjustment in the Transmission Charges in accordance with Schedule 9.

ARTICLE: 12

12 CHANGE IN LAW

12.1 Change in Law

12.1.1 Change in Law means the occurrence of any of the following after the Bid Deadline resulting into any additional recurring / non-recurring expenditure by the TSP or any savings of the TSP:

- the enactment, coming into effect, adoption, promulgation, amendment, modification or repeal (without re-enactment or consolidation) in India, of any Law, including rules and regulations framed pursuant to such Law, subject to the provisions under Article 12.1.2;
- a change in the interpretation or application of any Law by any Indian Governmental Instrumentality having the legal power to interpret or apply such Law, or any Competent Court of Law;
- the imposition of a requirement for obtaining any Consents, Clearances and Permits which was not required earlier;
- a change in the terms and conditions prescribed for obtaining any Consents, Clearances and Permits or the inclusion of any new terms or conditions for obtaining such Consents, Clearances and Permits;
- any change in the licensing regulations of the Commission, under which the Transmission License for the Project was granted if made applicable by such Commission to the TSP;
- change in wind zone; or
- any change in tax or introduction of any tax made applicable for providing Transmission Service by the TSP as per the terms of this Agreement.

12.1.2 Notwithstanding anything contained in this Agreement, Change in Law shall not cover any change:

- a) Taxes on corporate income; and
- b) Withholding tax on income or dividends distributed to the shareholders of the TSP.

12.2 Relief for Change in Law

12.2.1 During Construction Period, the impact of increase/decrease in the cost of the Project on the Transmission Charges shall be governed by the formula given in Schedule 9 of this Agreement.

12.2.2 During the Operation Period:

During the operation period, if as a result of Change in Law, the TSP suffers or is benefited from a change in costs or revenue, the aggregate financial effect of which exceeds 0.30% (zero point three percent) of the Annual Transmission Charges in aggregate for a Contract Year, the TSP may notify so to the Nodal Agency and propose amendments to this Agreement so as to place the TSP in the same financial position as it would have enjoyed had there been no such Change in Law resulting in change in costs or revenue as aforesaid.

12.2.3 For any claims made under Articles 12.2.1 and 12.2.2 above, the TSP shall provide to the Nodal Agency documentary proof of such increase / decrease in cost of the Project / revenue for establishing the impact of such Change in Law.

In cases where Change in Law results in decrease of cost and it comes to the notice of Nodal Agency that TSP has not informed Nodal Agency about such decrease in cost, Nodal Agency may initiate appropriate claim.

12.3 Notification of Change in Law:

- 12.3.1 If the TSP is affected by a Change in Law in accordance with Article 12.1 and wishes to claim relief for such Change in Law under this Article 12, it shall give notice to Nodal Agency of such Change in Law as soon as reasonably practicable after becoming aware of the same.
- 12.3.2 The TSP shall also be obliged to serve a notice to the Nodal Agency even when it is beneficially affected by a Change in Law.
- 12.3.3 Any notice served pursuant to Articles 12.3.1 and 12.3.2 shall provide, amongst other things, precise details of the Change in Law and its estimated impact on the TSP.

12.4 Payment on account of Change in Law

- 12.4.1 The payment for Change in Law shall be through a separate Bill. However, in case of any change in Monthly Transmission Charges by reason of Change in Law, as determined in accordance with this Agreement, the Bills to be raised by the Nodal Agency after such change in Transmission Charges shall appropriately reflect the changed Monthly Transmission Charges.

ARTICLE: 13

13 EVENTS OF DEFAULT AND TERMINATION

13.1 TSP's Event of Default

The occurrence and continuation of any of the following events shall constitute a TSP Event of Default, unless any such TSP Event of Default occurs as a result of any non-fulfilment of its obligations as prescribed under this Agreement by the Nodal Agency or a Force Majeure Event:

- a. After having taken up the construction of the Project, the abandonment by the TSP or the TSP's Contractors of the construction of the Project for a continuous period of two (2) months and such default is not rectified within thirty (30) days from the receipt of notice from the Nodal Agency in this regard;
- b. The failure to commission any Element of the Project by the date falling six (6) months after its Scheduled COD unless extended by Nodal Agency as per provisions of this Agreement;
- c. If the TSP:
 - i. assigns, mortgages or charges or purports to assign, mortgage or charge any of its assets or rights related to the Project in contravention of the provisions of this Agreement; or
 - ii. transfers or novates any of its obligations pursuant to this Agreement, in a manner contrary to the provisions of this Agreement;

Except where such transfer is in pursuance of a Law and

- it does not affect the ability of the transferee to perform, and such transferee has the financial and technical capability to perform, its obligations under this Agreement;
- is to a transferee who assumes such obligations under the Project and this Agreement remains effective with respect to the transferee;

- d. If:

Transmission Service Agreement

- i. The TSP becomes voluntarily or involuntarily the subject of any bankruptcy or insolvency or winding up proceedings and such proceedings remain uncontested for a period of thirty (30) days; or
- ii. any winding up or bankruptcy or insolvency order is passed against the TSP; or
- iii. the TSP goes into liquidation or dissolution or a receiver or any similar officer is appointed over all or substantially all of its assets or official liquidator is appointed to manage its affairs, pursuant to Law,

Provided that a dissolution or liquidation of the TSP will not be a TSP's Event of Default, where such dissolution or liquidation of the TSP is for the purpose of a merger, consolidation or reorganization with the prior approval of the Commission as per the provisions of Central Electricity Regulatory Commission (Procedure, terms and Conditions for grant of Transmission License and other related matters) Regulations, 2006 or as amended from time to time; or

- e. Failure on the part of the TSP to comply with the provisions of Article 19.1 of this Agreement; or
- f. the TSP repudiates this Agreement and does not rectify such breach even within a period of thirty (30) days from a notice from the Nodal Agency in this regard; or
- g. after Commercial Operation Date of the Project, the TSP fails to achieve monthly Target Availability of 98%, for a period of six (6) consecutive months or within a non-consecutive period of six (6) months within any continuous aggregate period of eighteen(18) months except where the Availability is affected by Force Majeure Events as per Article 11; or
- h. any of the representations and warranties made by the TSP in Article 17 of this Agreement being found to be untrue or inaccurate. Further, in addition to the above, any of the undertakings submitted by the Selected Bidder at the time of submission of the Bid being found to be breached or inaccurate, including but not limited to undertakings from its Parent Company / Affiliates related to the minimum equity obligation; or

- i. the TSP fails to complete / fulfil all the activities / conditions within the specified period as per Article 3; or
- j. except for the reasons solely attributable to Nodal Agency, the TSP is in material breach of any of its obligations under this Agreement and such material breach is not rectified by the TSP within thirty (30) days of receipt of notice in this regard from the Nodal Agency; or
- k. the TSP fails to take the possession of the land required for location specific substations, switching stations or HVDC terminal or inverter stations and / or fails to pay the requisite price to the parties and / or any State Government authority from whom the land is acquired, within twelve (12) months from the Effective Date.

13.2 Termination Procedure for TSP Event of Default

- a. Upon the occurrence and continuance of any TSP's Event of Default under Article 13.1 the Nodal Agency may serve notice on the TSP, with a copy to the CEA and the Lenders' Representative, of their intention to terminate this Agreement (a "Nodal Agency's Preliminary Termination Notice"), which shall specify in reasonable detail, the circumstances giving rise to such Nodal Agency's Preliminary Termination Notice.
- b. Following the issue of a Nodal Agency's Preliminary Termination Notice, the Consultation Period shall apply and would be for the Parties to discuss as to what steps shall be taken with a view to mitigate the consequences of the relevant Event of Default having regard to all the circumstances.
- c. During the Consultation Period, the Parties shall, save as otherwise provided in this Agreement, continue to perform their respective obligations/ roles under this Agreement, and the TSP shall not remove any material, equipment or any part of the Project, without prior consent of the Nodal Agency.

Following the expiry of the Consultation Period, unless the Parties shall have otherwise agreed to the contrary or the circumstances giving rise to Nodal Agency's Preliminary Termination Notice shall have ceased to exist or shall have been remedied, this Agreement may be terminated by the Nodal Agency by giving a Termination Notice to the TSP, in writing, of at least seven (7) days, with a copy to CEA and the Lenders' Representative in order to enable the Lenders to exercise right of substitution in accordance with Article 15.3 of this Agreement.

Further, the Nodal Agency may also initiate proceedings to blacklist the TSP & its Affiliates from participation in any RFP issued by BPCs for a period of 5 years.

13.3 Procedure for Nodal Agency's non-fulfilment of Role

- a. Upon the Nodal Agency not being able to fulfil its role under Article 4.2, the TSP may serve notice on the Nodal Agency, with a copy to CEA and the Lenders' Representative (a "TSP's Preliminary Notice"), which notice shall specify in reasonable detail the circumstances giving rise to such non-fulfilment of role by the Nodal Agency.
- b. Following the issue of a TSP's Preliminary Notice, the Consultation Period shall apply.
- c. The Consultation Period would be for the Parties to discuss as to what steps shall be taken with a view to mitigate the consequences of the relevant non-fulfilment of role by the Nodal Agency including giving time extension to TSP, having regard to all the circumstances.
- d. During the Consultation Period, both Parties shall, save as otherwise provided in this Agreement, continue to perform their respective obligations/ roles under this Agreement.

13.4 Termination due to Force Majeure

- 13.4.1 In case the Parties could not reach an agreement pursuant to Articles 3.3.4 and 4.4.2 of this Agreement and the Force Majeure Event or its effects continue to be present, the Nodal Agency shall have the right to cause termination of the Agreement. In case of such termination, the Contract Performance Guarantee shall be returned to the TSP as per the provisions of Article 6.5.1.

13.4.2 In case of termination of this Agreement, the TSP shall provide to the Nodal Agency the full names and addresses of its Contractors as well as complete designs, design drawings, manufacturing drawings, material specifications and technical information, as required by the Nodal Agency within thirty (30) days of Termination Notice.

13.5 Termination or amendment due to non-requirement of any Element or Project during construction

13.5.1 In case any Element or Project, which is under construction, is no longer required due to any reason whatsoever, the Nodal Agency may issue a notice to this effect to the TSP.

13.5.2 Nodal agency may also issue notice to the TSP seeking their response to the proposed termination/ amendment (as the case may be) of the Agreement. The Nodal Agency shall issue copy of such notice to Lenders. In the notice, Nodal Agency shall also include an assessment of the physical progress made by TSP in the Element/ Project (as the case may be) that is no longer required.

13.5.3 The TSP shall neither carry out further investment nor carry out any work on the Element/ Project (as the case may be) that is no longer required after delivery of the notice.

13.5.4 After taking into account the comments of the TSP, the Nodal Agency may terminate the Agreement or amend it if both Parties agree to the amendment.

13.6 Revocation of the Transmission License

13.6.1 The Commission may, as per the provisions of the Electricity Act, 2003, revoke the Transmission License of the ISTS Licensee. Further, in such a case, the Agreement shall be deemed to have been terminated.

13.7 Termination Payment

13.7.1 If Agreement is terminated on account of Force Majeure Events, non-requirement of any Element or Project during Construction, Nodal Agency's non-fulfilment of Role & TSP's Event of Default, the TSP shall be entitled for Termination Payment equivalent to valuation of Project Assets. Upon payment, the Nodal Agency shall take over the Project Assets.

ARTICLE: 14

14 LIABILITY AND INDEMNIFICATION

14.1 Indemnity

14.1.1 The TSP shall indemnify, defend and hold the Nodal Agency harmless against:

- (a) any and all third party claims, actions, suits or proceedings against the Nodal Agency for any loss of or damage to property of such third party, or death or injury to such third party, arising out of a breach by the TSP of any of its obligations under this Agreement, except to the extent that any such claim, action, suit or proceeding has arisen due to a negligent act or omission, breach of this Agreement or non-fulfilment of statutory duty on the part of Nodal Agency; and
- (b) any and all losses, damages, costs and expenses including legal costs, fines, penalties and interest actually suffered or incurred by the Nodal Agency from third party claims arising by reason of:
 - i. a breach by the TSP of any of its obligations under this Agreement, (provided that this Article 14 shall not apply to such breaches by the TSP, for which specific remedies have been provided for under this Agreement) except to the extent that any such losses, damages, costs and expenses including legal costs, fines, penalties and interest (together to constitute “Indemnifiable Losses”) has arisen due to a negligent act or omission, breach of this Agreement or non-fulfilment of statutory duty on the part of the Nodal Agency, or
 - ii. any of the representations and warranties of the TSP under this Agreement being found to be inaccurate or untrue.

14.1.2 The Nodal Agency shall, in accordance with the Regulations framed by CERC in this regard, indemnify, defend and hold the TSP harmless against:

- (a) any and all third party claims, actions, suits or proceedings against the TSP, for any loss of or damage to property of such third party, or death or injury to such third party, arising out of any material breach by the Nodal Agency of any of their roles under this Agreement, except to the extent that any such claim, action, suit or proceeding has arisen due to a negligent act or omission, breach of this Agreement or breach of statutory duty on the part of the TSP, its Contractors, servants or agents; and

- (b) any and all losses, damages, costs and expenses including legal costs, fines, penalties and interest ('Indemnifiable Losses') actually suffered or incurred by the TSP from third party claims arising by reason of:
 - i. any material breach by the Nodal Agency of any of its roles under this Agreement (provided that, this Article 14 shall not apply to such breaches by the Nodal Agency, for which specific remedies have been provided for under this Agreement), except to the extent that any such Indemnifiable Losses have arisen due to a negligent act or omission, breach of this Agreement or breach of statutory duty on the part of the TSP, its Contractors, servants or agents or
 - ii. any of the representations and warranties of the Nodal Agency under this Agreement being found to be inaccurate or untrue.

14.2 Patent Indemnity:

14.2.1

- (a) The TSP shall, subject to the Nodal Agency's compliance with Article 14.2.1 (b), indemnify and hold harmless the Nodal Agency and its employees and officers from and against any and all suits, actions or administrative proceedings, claims, demands, losses, damages, costs, and expenses of whatsoever nature, including attorney's fees and expenses, which the Nodal Agency may suffer as a result of any infringement or alleged infringement of any patent, utility model, registered design, trademark, copyright or other intellectual property right registered or otherwise existing at the date of the Agreement by reason of the setting up of the Project by the TSP.

Such indemnity shall not cover any use of the Project or any part thereof other than for the purpose indicated by or to be reasonably inferred from the Agreement, any infringement resulting from the misuse of the Project or any part thereof, or any products produced in association or combination with any other equipment, plant or materials not supplied by the TSP, pursuant to the Agreement.

- (b) If any proceedings are brought or any claim is made against the Nodal Agency arising out of the matters referred to in Article 14.2.1(a), the Nodal Agency shall promptly give the TSP a notice thereof, and the TSP shall at its own expense take necessary steps and attend such proceedings or claim and any negotiations for the settlement of any such proceedings or claim. The TSP shall promptly notify the Nodal Agency of all actions

taken in such proceedings or claims.

- (c) If the TSP fails to notify the Nodal Agency within twenty-eight (28) days after receipt of such notice from the Nodal Agency under Article 14.2.1(b) above, that it intends to attend any such proceedings or claim, then the Nodal Agency shall be free to attend the same on their own behalf at the cost of the TSP. Unless the TSP has so failed to notify the Nodal Agency within the twenty eight (28) days period, the Nodal Agency shall make no admission that may be prejudicial to the defence of any such proceedings or claims.
- (d) The Nodal Agency shall, at the TSP's request, afford all available assistance to the TSP in attending to such proceedings or claim, and shall be reimbursed by the TSP for all reasonable expenses incurred in so doing.

14.2.2

- (a) The Nodal Agency, in accordance with the Regulations framed by CERC in this regard, subject to the TSP's compliance with Article 14.2.2(b) shall indemnify and hold harmless the TSP and its employees, officers from and against any and all suits, actions or administrative proceedings, claims, demands, losses, damages, costs and expenses of whatsoever nature, including attorney's fees and expenses, which the TSP may suffer as a result of any infringement or alleged infringement of any patent, utility model, registered design, trademark, copyright or other intellectual property right registered or otherwise existing at the date of the Agreement by reason of the setting up of the Project by the TSP.
- (b) If any proceedings are brought or any claim is made against the TSP arising out of the matters referred to in Article 14.2.2 (a) the TSP shall promptly give the Nodal Agency a notice thereof, and the Nodal Agency shall at its own expense take necessary steps and attend such proceedings or claim and any negotiations for the settlement of any such proceedings or claim. The Nodal Agency shall promptly notify the TSP of all actions taken in such proceedings or claims.
- (c) If the Nodal Agency fails to notify the TSP within twenty-eight (28) days after receipt of such notice from the TSP under Article 14.2.2(b) above, that it intends to attend any such proceedings or claim, then the TSP shall be free to attend the same on its own behalf at the cost of the Nodal Agency. Unless the Nodal Agency has so failed to notify the TSP within the twenty (28) days period, the TSP shall make no admission that may be prejudicial to the defence of any such proceedings or claim.

- (d) The TSP shall, at the Nodal Agency request, afford all available assistance to the Nodal Agency in attending to such proceedings or claim, and shall be reimbursed by the Nodal Agency for all reasonable expenses incurred in so doing.

14.3 Monetary Limitation of liability

- 14.3.1 A Party ("Indemnifying Party") shall be liable to indemnify the other Party ("Indemnified Party") under this Article 14 for any indemnity claims made in a Contract Year only up to an amount of Rupees Nine Crore Thirty Lakh Only (Rs. 9.30 Crore).

14.4 Procedure for claiming indemnity

- 14.4.1 Where the Indemnified Party is entitled to indemnification from the Indemnifying Party pursuant to Articles 14.1 or 14.2 the Indemnified Party shall promptly notify the Indemnifying Party of such claim, proceeding, action or suit referred to in Articles 14.1 or 14.2 in respect of which it is entitled to be indemnified. Such notice shall be given as soon as reasonably practicable after the Indemnified Party becomes aware of such claim, proceeding, action or suit. The Indemnifying Party shall be liable to settle the indemnification claim within thirty (30) days of receipt of the above notice.

Provided however that, if:

- i. the Parties choose to contest, defend or litigate such claim, action, suit or proceedings in accordance with Article 14.4.3 below; and
- ii. the claim amount is not required to be paid/deposited to such third party pending the resolution of the Dispute,

the Indemnifying Party shall become liable to pay the claim amount to the Indemnified Party or to the third party, as the case may be, promptly following the resolution of the Dispute, if such Dispute is not settled in favour of the Indemnified Party.

- 14.4.2 The Indemnified Party may contest, defend and litigate a claim, action, suit or proceeding for which it is entitled to be indemnified under Articles 14.1 or 14.2 and the Indemnifying Party shall reimburse to the Indemnified Party all reasonable costs and expenses incurred by the Indemnified Party. However, such Indemnified Party shall not settle or compromise such claim, action, suit or proceedings without first getting the consent of the Indemnifying Party, which consent shall not be unreasonably withheld or delayed.

- 14.4.3 An Indemnifying Party may, at its own expense, assume control of the defence of any proceedings brought against the Indemnified Party if it acknowledges its obligation to indemnify such Indemnified Party, gives such Indemnified Party prompt notice of its intention to assume control of the defence, and employs an independent legal counsel at its own cost that is reasonably satisfactory to the Indemnified Party.

14.5 Limitation on Liability

- 14.5.1 Except as expressly provided in this Agreement, neither the TSP nor the Nodal Agency nor their respective officers, directors, agents, employees or Affiliates (including, officers, directors, agents or employees of such Affiliates), shall be liable or responsible to the other Party or its Affiliates including its officers, directors, agents, employees, successors, insurers or permitted assigns for incidental, indirect or consequential, punitive or exemplary damages, connected with or resulting from performance or non-performance of this Agreement, or anything done in connection herewith, including claims in the nature of lost revenues, income or profits (other than payments expressly required and properly due under this Agreement), any increased expense of, reduction in or loss of transmission capacity or equipment used therefore, irrespective of whether such claims are based upon breach of warranty, tort (including negligence, whether of the Nodal Agency, the TSP or others), strict liability, contract, breach of statutory duty, operation of law or otherwise.

- 14.5.2 The Nodal Agency shall have no recourse against any officer, director or shareholder of the TSP or any Affiliate of the TSP or any of its officers, directors or shareholders for such claims excluded under this Article. The TSP shall also have no recourse against any officer, director or shareholder of the Nodal Agency, or any Affiliate of the Nodal Agency or any of its officers, directors or shareholders for such claims excluded under this Article.

14.6 Duty to Mitigate

The party entitled to the benefit of an indemnity under this Article 14 shall take all reasonable measures to mitigate any loss or damage which has occurred. If the Party fails to take such measures, the other Party's liabilities shall be correspondingly reduced.

ARTICLE: 15

15 ASSIGNMENTS AND CHARGES

15.1 Assignments:

15.1.1 This Agreement shall be binding upon, and inure to the benefit of the Parties and their respective successors and permitted assigns. This Agreement shall not be assigned by any Party, except as provided in Article 15.3.

15.2 Permitted Charges:

15.2.1 Neither Party shall create or permit to subsist any encumbrance over all or any of its rights and benefits under this Agreement.

15.2.2 However, the TSP may create any encumbrance over all or part of the receivables, or the Project Assets of the Project in favour of the Lenders or the Lenders' Representative on their behalf, as security for amounts payable under the Financing Agreements and any other amounts agreed by the Parties.

Provided that:

- i. the Lenders or the Lenders' Representative on their behalf shall have entered into the Financing Agreements and agreed in writing to the provisions of this Agreement; and
- ii. any encumbrance granted by the TSP in accordance with this Article 15.2.2 shall contain provisions pursuant to which the Lenders or the Lender's Representative on their behalf agrees unconditionally with the TSP to release from such encumbrances upon payment by the TSP to the Lenders of all amounts due under the Financing Agreements.

15.2.3 Article 15.2.1 does not apply to:

- a. liens arising by operation of law (or by an agreement evidencing the same) in the ordinary course of the TSP developing and operating the Project;
- b. pledges of goods, the related documents of title and / or other related documents, arising or created in the ordinary course of the TSP developing and operating the Project; or
- c. security arising out of retention of title provisions in relation to goods acquired in the ordinary course of the TSP developing and operating the Project.

15.3 Substitution Rights of the Lenders

- 15.3.1 The TSP would need to operate and maintain the Project under the provisions of this Agreement and cannot assign the Transmission License or transfer the Project or part thereof to any person by sale, lease, exchange or otherwise, without the prior approval of the Nodal Agency.
- 15.3.2 However, in the case of default by the TSP in debt repayments or in the case of default by the TSP as per Article 13 of this Agreement during the debt repayments, the Commission may, on an application from the Lenders, assign the Transmission License to the nominee of the Lenders subject to the fulfilment of the qualification requirements and provisions of the Central Electricity Regulatory Commission (Procedure, terms and Conditions for grant of Transmission License and other related matters) Regulations, 2006 and as amended from time to time.

ARTICLE: 16

16 GOVERNING LAW AND DISPUTE RESOLUTION

16.1 Governing Law:

This Agreement shall be governed by and construed in accordance with the Laws of India. Any legal proceedings in respect of any matters, claims or disputes under this Agreement shall be under the jurisdiction of appropriate courts in Delhi.

16.2 Amicable Settlement:

16.2.1 Either Party is entitled to raise any claim, dispute or difference of whatever nature arising under, out of or in connection with this Agreement, including its existence or validity or termination or whether during the execution of the Project or after its completion and whether prior to or after the abandonment of the Project or termination or breach of the Agreement by giving a written notice to the other Party, which shall contain:

- (i) a description of the Dispute;
- (ii) the grounds for such Dispute; and
- (iii) all written material in support of its claim.

16.2.2 The other Party shall, within thirty (30) days of issue of notice issued under Article 16.2.1, furnish:

- (i) counter-claim and defences, if any, regarding the Dispute; and
- (ii) all written material in support of its defences and counter-claim.

16.2.3 Within thirty (30) days of issue of notice by the Party pursuant to Article 16.2.1, if the other Party does not furnish any counter claim or defense under Article 16.2.2, or thirty (30) days from the date of furnishing counter claims or defence by the other Party, both the Parties to the Dispute shall meet to settle such Dispute amicably. If the Parties fail to resolve the Dispute amicably within thirty (30) days from the later of the dates mentioned in this Article 16.2.3, the Dispute shall be referred for dispute resolution in accordance with Article 16.3.

16.3 Dispute Resolution:

All Disputes shall be adjudicated by the Commission.

16.4 Parties to Perform Obligations:

Transmission Service Agreement

Notwithstanding the existence of any Dispute and difference referred to the Commission as provided in Article 16.3 and save as the Commission may otherwise direct by a final or interim order, the Parties hereto shall continue to perform their respective obligations/ roles (which are not in dispute) under this Agreement.

ARTICLE: 17

17 REPRESENTATION AND WARRANTIES

17.1 Representation and warranties of the Nodal Agency

17.1.1 The Nodal Agency hereby represents and warrants to and agrees with the TSP as follows and acknowledges and confirms that the TSP is relying on such representations and warranties in connection with the transactions described in this Agreement:

- a. It has all requisite powers and authority to execute and consummate this Agreement;
- b. This Agreement is enforceable against the Nodal Agency in accordance with its terms;
- c. The consummation of the transactions contemplated by this Agreement on the part of Nodal Agency will not violate any provision of nor constitute a default under, nor give rise to a power to cancel any charter, mortgage, deed of trust or lien, lease, agreement, license, permit, evidence of indebtedness, restriction, or other contract to which the Nodal Agency is a Party or to which the Nodal Agency is bound, which violation, default or power has not been waived;

17.2 Representation and Warranties of the TSP:

17.2.1 The TSP hereby represents and warrants to and agrees with the Nodal Agency as follows and acknowledges and confirms that the Nodal Agency is relying on such representations and warranties in connection with the transactions described in this Agreement:

- a. It has all requisite powers and has been duly authorized to execute and consummate this Agreement;
- b. This Agreement is enforceable against it, in accordance with its terms;
- c. The consummation of the transactions contemplated by this Agreement on the part of the TSP will not violate any provision of nor constitute a default under, nor give rise to a power to cancel any charter, mortgage, deed of trust or lien, lease, agreement, license, permit, evidence of indebtedness, restriction, or other contract to which the TSP is a Party or to which the TSP is bound which violation, default or power has not been waived;
- d. The TSP is not insolvent and no insolvency proceedings have been instituted, nor threatened or pending by or against the TSP;

Transmission Service Agreement

- e. There are no actions, suits, claims, proceedings or investigations pending or, to the best of the TSP's knowledge, threatened in writing against the TSP at law, in equity, or otherwise, and whether civil or criminal in nature, before or by, any court, commission, arbitrator or governmental agency or authority, and there are no outstanding judgments, decrees or orders of any such courts, commission, arbitrator or governmental agencies or authorities, which materially adversely affect its ability to execute the Project or to comply with its obligations under this Agreement.

17.2.2 The TSP makes all the representations and warranties above to be valid as on the Effective Date of this Agreement.

ARTICLE: 18

18 INDEPENDENT ENGINEER

18.1 Appointment of Independent Engineer

The Nodal Agency shall appoint an agency/ company as Independent Engineer as per framework provided in the Guidelines for Encouraging Competition in Development of Transmission Projects for selection of Independent Engineer.

18.2 Roles and functions of Independent Engineer

The role and functions of the Independent Engineer shall include the following:

- a. Progress Monitoring as required under this Agreement;
- b. Ensuring Quality as required under this Agreement;
- c. determining, as required under the Agreement, the costs of any works or services and/or their reasonableness during construction phase;
- d. determining, as required under the Agreement, the period or any extension thereof, for performing any duty or obligation during construction phase;
- e. determining, as required under the Agreement, the valuation of the Project Assets.
- f. Assisting the Parties in resolution of Disputes and
- g. Undertaking all other duties and functions in accordance with the Agreement.

18.3 Remuneration of Independent Engineer

The fee and charges of the Independent Engineer shall be paid by the Nodal Agency as per terms & conditions of appointment.

18.4 Termination of appointment

18.4.1 The Nodal Agency may, in its discretion, terminate the appointment of the Independent Engineer at any time, but only after appointment of another Independent Engineer.

18.4.2 If the TSP has reason to believe that the Independent Engineer is not discharging its duties and functions in a fair, efficient and diligent manner, it may make a written representation to the Nodal Agency and seek termination of the appointment of the Independent Engineer. Upon receipt of such representation, the Nodal Agency shall hold a tripartite meeting with the TSP and Independent Engineer for an amicable

resolution, and the decision of Nodal agency is final. In the event that the appointment of the Independent Engineer is terminated hereunder, the Nodal Agency shall appoint forthwith another Independent Engineer.

18.5 Authorised signatories

The Nodal Agency shall require the Independent Engineer to designate and notify to the Nodal Agency up to 2 (two) persons employed in its firm to sign for and on behalf of the Independent Engineer, and any communication or document required to be signed by the Independent Engineer shall be valid and effective only if signed by any of the designated persons; provided that the Independent Engineer may, by notice in writing, substitute any of the designated persons by any of its employees.

ARTICLE: 19

19 MISCELLANEOUS PROVISIONS

19.1 Equity Lock-in Commitment:

19.1.1 The aggregate equity share holding of the Selected Bidder in the issued and paid up equity share capital of Bikaner B Power Transmission Limited shall not be less than Fifty one percent (51%) up to a period of one (1) year after COD of the Project.

Provided that, in case the Lead Member or Bidding Company is holding equity through Affiliate/s, Ultimate Parent Company or Parent Company, such restriction as specified above shall apply to such entities.

Provided further, that in case the Selected Bidder is a Bidding Consortium, the Lead Member shall continue to hold equity of at least twenty six percent (26%) upto a period of one (1) year after COD of the Project and any Member of such Bidding Consortium shall be allowed to divest its equity as long as the other remaining Members (which shall always include the Lead Member) hold the minimum equity specified above.

19.1.2 If equity is held by the Affiliates, Parent Company or Ultimate Parent Company of the Selected Bidder, then, subject to the second proviso to Article 19.1.1, such Affiliate, Parent Company or Ultimate Parent Company shall be eligible to transfer its shareholding in Bikaner B Power Transmission Limited to another Affiliate or to the Parent Company / Ultimate Parent Company of the Selected Bidder. If any such shareholding entity, qualifying as an Affiliate / Parent Company / Ultimate Parent Company, is likely to cease to meet the criteria to qualify as an Affiliate / Parent Company / Ultimate Parent Company, the shares held by such entity shall be transferred to another Affiliate / Parent Company / Ultimate Parent Company of the Selected Bidder.

19.1.3 Subject to Article 19.1.1, all transfer(s) of shareholding of Bikaner B Power Transmission Limited by any of the entities referred to in Article 19.1.1 and 19.1.2 above, shall be after prior written intimation to the Nodal Agency.

19.1.4 For computation of effective Equity holding, the Equity holding of the Selected Bidder or its Ultimate Parent Company in such Affiliate(s) or Parent Company and the equity holding of such Affiliate(s) or Ultimate Parent Company in Bikaner B Power Transmission Limited shall be computed in accordance with the example given below:

If the Parent Company or the Ultimate Parent Company of the Selected Bidder A directly holds thirty percent (30%) of the equity in Bikaner B Power

Transmission Limited then holding of Selected Bidder A in Bikaner B Power Transmission Limited shall be thirty percent (30%);

If Selected Bidder A holds thirty percent (30%) equity of the Affiliate and the Affiliate holds fifty percent (50%) equity in Bikaner B Power Transmission Limited, then, for the purposes of ascertaining the minimum equity/equity lock-in requirements specified above, the effective holding of Bidder A in Bikaner B Power Transmission Limited shall be fifteen percent (15%), (i.e., 30% x 50%)

19.1.5 The provisions as contained in this Article 19.1 shall override the terms of the consortium agreement submitted as part of the Bid.

19.1.6 The TSP shall be responsible to report to Nodal Agency, within thirty (30) days from the occurrence of any event that would result in any change in its equity holding structure from that which existed as on the date of signing of the Share Purchase Agreement. In such cases, the Nodal Agency would reserve the right to ascertain the equity holding structure and to call for all such required documents / information / clarifications as may be required.

19.2 Commitment of maintaining Qualification Requirement

19.2.1 The Selected Bidder will be required to continue to maintain compliance with the Qualification Requirements, as stipulated in RFP Document, till the COD of the Project. Where the Technically Evaluated Entity and/or the Financially Evaluated Entity is not the Bidding Company or a Member in a Bidding Consortium, as the case may be, the Bidding Company or Member shall continue to be an Affiliate of the Technically Evaluated Entity and/or Financially Evaluated Entity till the COD of the Project.

19.2.2 Failure to comply with the aforesaid provisions shall be dealt in the same manner as TSP's Event of Default as under Article 13 of this Agreement.

19.3 Language:

19.3.1 All agreements, correspondence and communications between the Parties relating to this Agreement and all other documentation to be prepared and supplied under the Agreement shall be written in English, and the Agreement shall be construed and interpreted in accordance with English language.

19.3.2 If any of the agreements, correspondence, communications or documents are prepared in any language other than English, the English translation of such agreements, correspondence, communications or documents shall prevail in matters of interpretation.

19.4 Affirmation

The TSP and the Nodal Agency, each affirm that:

1. neither it nor its respective directors, employees, or agents has paid or undertaken to pay or shall in the future pay any unlawful commission, bribe, pay-off or kick-back; and
2. it has not in any other manner paid any sums, whether in Indian currency or foreign currency and whether in India or abroad to the other Party to procure this Agreement, and the TSP and the Nodal Agency hereby undertake not to engage in any similar acts during the Term of Agreement.

19.5 Severability

The invalidity or enforceability, for any reason, of any part of this Agreement shall not prejudice or affect the validity or enforceability of the remainder of this Agreement, unless the part held invalid or unenforceable is fundamental to this Agreement.

19.6 Counterparts

This Agreement may be executed in one or more counterparts, each of which shall be deemed an original and all of which collectively shall be deemed one and the same Agreement.

19.7 Breach of Obligations/ Roles

The Parties acknowledge that a breach of any of the obligations/ roles contained herein would result in injuries. The Parties further acknowledge that the amount of the liquidated damages or the method of calculating the liquidated damages specified in this Agreement is a genuine and reasonable pre-estimate of the damages that may be suffered by the non-defaulting Party in each case specified under this Agreement.

19.8 Restriction of Shareholders / Owners Liability

19.8.1 Parties expressly agree and acknowledge that none of the shareholders of the Parties hereto shall be liable to the other Parties for any of the contractual obligations of the concerned Party under this Agreement.

19.8.2 Further, the financial liabilities of the shareholder(s) of each Party to this Agreement shall be restricted to the extent provided in the Indian Companies Act, 1956 / Companies Act, 2013 (as the case may be).

19.9 Taxes and Duties:

19.9.1 The TSP shall bear and promptly pay all statutory taxes, duties, levies and cess, assessed/levied on the TSP, its Contractors or their employees that are required to be paid by the TSP as per the Law in relation to the execution of the Project and for providing Transmission Service as per the terms of this Agreement.

19.9.2 The Nodal Agency shall be indemnified and held harmless by the TSP against any claims that may be made against the Nodal Agency in relation to the matters set out in Article 19.9.1.

19.9.3 The Nodal Agency shall not be liable for any payment of, taxes, duties, levies, cess whatsoever for discharging any obligation of the TSP by the Nodal Agency on behalf of TSP or its personnel, provided the TSP has consented in writing to the Nodal Agency for such work, for which consent shall not be unreasonably withheld.

19.10 No Consequential or Indirect Losses

The liability of the TSP shall be limited to that explicitly provided in this Agreement.

Provided that, notwithstanding anything contained in this Agreement, under no event shall the Nodal Agency or the TSP claim from one another any indirect or consequential losses or damages.

19.11 Discretion:

Except where this Agreement expressly requires a Party to act fairly or reasonably, a Party may exercise any discretion given to it under this Agreement in any way it deems fit.

19.12 Confidentiality

19.12.1 The Parties undertake to hold in confidence this Agreement and RFP Project Documents and not to disclose the terms and conditions of the transaction contemplated hereby to third parties, except:

- (a) to their professional advisors;
- (b) to their officers, contractors, employees, agents or representatives, financiers, who need to have access to such information for the proper performance of their activities; or
- (c) disclosures required under Law,

without the prior written consent of the other Parties.

Provided that, the TSP agrees and acknowledges that the Nodal Agency, may, at any time, disclose the terms and conditions of the Agreement and the RFP Project Documents to any person, to the extent stipulated under the Law and the Competitive Bidding Guidelines.

19.13 Order of priority in application:

Transmission Service Agreement

Save as provided in Article 2.5, in case of inconsistencies between the terms and conditions stipulated in Transmission License issued by the Commission to the TSP, agreement(s) executed between the Parties, applicable Law including rules and regulations framed thereunder, the order of priority as between them shall be the order in which they are placed below:

- terms and conditions of Transmission License;
- applicable Law, rules and regulations framed thereunder;
- this Agreement;
- Agreement(s), if any, under Sharing Regulations.

19.14 Independent Entity:

- 19.14.1 The TSP shall be an independent entity performing its obligations pursuant to the Agreement.
- 19.14.2 Subject to the provisions of the Agreement, the TSP shall be solely responsible for the manner in which its obligations under this Agreement are to be performed. All employees and representatives of the TSP or Contractors engaged by the TSP in connection with the performance of the Agreement shall be under the complete control of the TSP and shall not be deemed to be employees, representatives, Contractors of the Nodal Agency and nothing contained in the Agreement or in any agreement or contract awarded by the TSP shall be construed to create any contractual relationship between any such employees, representatives or Contractors and the Nodal Agency.

19.15 Amendments:

- 19.15.1 This Agreement may only be amended or supplemented by a written agreement between the Parties.

19.16 Waiver:

- 19.16.1 No waiver by either Party of any default or breach by the other Party in the performance of any of the provisions of this Agreement shall be effective unless in writing duly executed by an authorised representative of such Party.
- 19.16.2 Neither the failure by either Party to insist on any occasion upon the performance of the terms, conditions and provisions of this Agreement nor time or other indulgence granted by one Party to the other Parties shall act as a waiver of such breach or acceptance of any variation or the relinquishment of any such right or any other right under this Agreement, which shall remain in full force and effect.

19.17 Relationship of the Parties:

This Agreement shall not be interpreted or construed to create an association, joint venture, or partnership or agency or any such other relationship between the Parties or to impose any partnership obligation or liability upon either Party and neither Party shall have any right, power or authority to enter into any agreement or undertaking for, or act on behalf of, or to act as or be an agent or representative of, or to otherwise bind, the other Party.

19.18 Entirety:

19.18.1 This Agreement along with its sections, schedules and appendices is intended by the Parties as the final expression of their agreement and is intended also as a complete and exclusive statement of the terms of their agreement.

19.18.2 Except as provided in this Agreement, all prior written or oral understandings, offers or other communications of every kind pertaining to this Agreement or the provision of Transmission Service under this Agreement to the Nodal Agency by the TSP shall stand superseded and abrogated.

19.19 Notices:

19.19.1 All notices or other communications which are required to be given under this Agreement shall be in writing and in the English language

19.19.2 If to the TSP, all notices or communications must be delivered personally or by registered post or facsimile or any other mode duly acknowledged to the addressee below:

Address :
Attention :
Email :
Fax. No. :
Telephone No.:

19.19.3 If to the Nodal Agency, all notices or communications must be delivered personally or by registered post or facsimile or any other mode duly acknowledged to the addresses below:

(i) Central Transmission Utility of India Limited (Nodal Agency)

Address : 5th to 10th Floor, IRCON International Tower,

Transmission Service Agreement

Tower no-1, Plot no -16 , Sector-32, Gurugram,

Haryana :122003

Attention : Mr. Atul Kumar Agarwal

Email : atul_ag@powergrid.in

Fax. No. : -

Telephone No. : 9910378059

19.19.4 All notices or communications given by facsimile shall be confirmed by sending a copy of the same via post office in an envelope properly addressed to the appropriate Party for delivery by registered mail. All notices shall be deemed validly delivered upon receipt evidenced by an acknowledgement of the recipient, unless the Party delivering the notice can prove in case of delivery through the registered post that the recipient refused to acknowledge the receipt of the notice despite efforts of the postal authorities.

19.19.5 Any Party may by notice of at least fifteen (15) days to the other Party change the address and/or addresses to which such notices and communications to it are to be delivered or mailed.

19.20 Fraudulent and Corrupt Practices

19.20.1 The TSP and its respective officers, employees, agents and advisers shall observe the highest standard of ethics during the subsistence of this Agreement. Notwithstanding anything to the contrary contained in the Agreement, the Nodal Agency may terminate the Agreement without being liable in any manner whatsoever to the TSP, if it determines that the TSP has, directly or indirectly or through an agent, engaged in corrupt practice, fraudulent practice, coercive practice, undesirable practice or restrictive practice in the Bid process. In such an event, the Nodal Agency shall forfeit the Contract Performance Guarantee of the TSP, without prejudice to any other right or remedy that may be available to the Nodal Agency hereunder or subsistence otherwise.

19.20.2 Without prejudice to the rights of the Nodal Agency under Clause 19.20.1 hereinabove and the rights and remedies which the Nodal Agency may have under this Agreement, if a TSP is found by the Nodal Agency to have directly or indirectly or through an agent, engaged or indulged in any corrupt practice, fraudulent practice, coercive practice, undesirable practice or restrictive practice during the Bid process, or after the issue of Letter of Intent (hereinafter referred to as LoI) or after the execution of the agreement(s) required under Sharing Regulations, the Nodal Agency may terminate the Agreement without being

liable in any manner whatsoever to the TSP. Further, the TSP & its Affiliates shall not be eligible to participate in any tender or RFP issued by any BPC for an indefinite period from the date such TSP is found by the Nodal Agency to have directly or indirectly or through an agent, engaged or indulged in any corrupt practice, fraudulent practice, coercive practice, undesirable practice or restrictive practices, as the case may be.

19.20.3 For the purposes of this Clause **19.20**, the following terms shall have the meaning hereinafter respectively assigned to them:

(a) **“corrupt practice”** means (i) the offering, giving, receiving, or soliciting, directly or indirectly, of anything of value to influence the actions of any person connected with the Bid process (for avoidance of doubt, offering of employment to or employing or engaging in any manner whatsoever, directly or indirectly, any official of the BPC who is or has been associated or dealt in any manner, directly or indirectly with the Bid process or the LoI or has dealt with matters concerning the RFP Project Documents or arising there from, before or after the execution thereof, at any time prior to the expiry of one year from the date such official resigns or retires from or otherwise ceases to be in the service of the BPC, shall be deemed to constitute influencing the actions of a person connected with the Bid Process); or (ii) engaging in any manner whatsoever, whether during the Bid Process or after the issue of the LoI or after the execution of the RFP Project Documents, as the case may be, any person in respect of any matter relating to the Project or the LoI or the RFP Project Documents, who at any time has been or is a legal, financial or technical adviser of the BPC in relation to any matter concerning the Project;

(b) **“fraudulent practice”** means a misrepresentation or omission of facts or suppression of facts or disclosure of incomplete facts, in order to influence the Bid process;

(c) **“coercive practice”** means impairing or harming, or threatening to impair or harm, directly or indirectly, any person or property to influence any person’s participation or action in the Bid process;

(d) **“undesirable practice”** means (i) establishing contact with any person connected with or employed or engaged by the BPC with the objective of canvassing, lobbying or in any manner influencing or attempting to influence the Bid process; or (ii) having a Conflict of Interest; and

(e) **“restrictive practice”** means forming a cartel or arriving at any understanding or arrangement among Bidders with the objective of restricting or manipulating a full and fair competition in the Bid process;

19.21 Compliance with Law:

Despite anything contained in this Agreement but without prejudice to Article 12,

Transmission Service Agreement

if any provision of this Agreement shall be in deviation or inconsistent with or repugnant to the provisions contained in the Electricity Act, 2003, or any rules and regulations made there under, such provision shall be deemed to be amended to the extent required to bring it into compliance with the aforesaid relevant provisions as amended from time to time.

IN WITNESS WHEREOF, THE PARTIES HAVE CAUSED THIS AGREEMENT TO BE EXECUTED BY THEIR DULY AUTHORISED REPRESENTATIVES AS OF THE DATE AND PLACE SET FORTH

Transmission Service Agreement

ABOVE.

1. For and on behalf of TSP

.....

[Signature, Name, Designation and Address]

2. For and on behalf of[Insert name of the Nodal Agency]

.....

[Signature, Name, Designation and Address]

WITNESSES:

1. For and on behalf of

: BPC

.....

[Signature]

.....

[Insert, Name, Designation and Address of the Witness]

2. For and on behalf of

: Nodal Agency

.....

[Signature]

.....

[Insert Name, Designation and Address of the Witness]

SCHEDULES

Schedule: 1**Project Description and Scope of Project****Scope of the Project:**

Sl. No.	Scope of the Transmission Scheme	Scheduled COD in months from Effective Date
1.	<p>Establishment of 765/400kV, 6x1500 MVA S/s at suitable location near Siwani (Distt. Bhiwani) along with 2x240 MVA (765kV) Bus Reactor & 2x125 MVA (420kV) Bus Reactor</p> <p>Siwani S/s- AIS</p> <ul style="list-style-type: none"> • 765/400 kV 1500 MVA ICTs- 6 nos. (19x500 MVA including one spare unit) • 765 kV ICT bays-6 no. • 400 kV ICT bays- 6 no. • 765 kV line bays – 2 nos. (for 765kV interconnection with Bikaner-IV PS) • 400 kV line bays – 4 nos. (for 400kV interconnections) • 240 MVA Bus Reactor-2 no. (7x80 MVA, including one spare unit) • 765 kV Bus reactor bays-2 no. • 125 MVA Bus Reactor-2 nos. • 400 kV Bus reactor bays- 2 nos. • 400kV Sectionalizer bay- 1 set • 400kV bays - 2 nos. (for STATCOM) <p>Future provisions at Siwani S/s:</p> <p>Space for</p> <ul style="list-style-type: none"> • 765 kV line bays along with switchable line reactors – 8 • 765kV Bus Reactor along with bay: 1 nos. • 400 kV line bays along with switchable line reactor –8 nos. • 400 kV Bus Reactor along with bays: 1 no. • 400kV Sectionalizer bay: 1 set 	11/11/2026
2.	<p>Bikaner-IV PS – Siwani 765 kV D/c (2nd) line along with 240 MVA switchable line reactor for each circuit at each end</p> <ul style="list-style-type: none"> • 765 kV, 240 MVA switchable line reactors at Bikaner- 	

Sl. No.	Scope of the Transmission Scheme	Scheduled COD in months from Effective Date
	IV PS end– 2 nos. <ul style="list-style-type: none"> • 765 kV, 240 MVAR switchable line reactors at Siwani S/s end– 2 nos. • Switching equipment for 765kV, 240 MVAR switchable line reactors at Bikaner-IV PS end – 2 nos. • Switching equipment for 765kV, 240 MVAR switchable line reactors at Siwani S/s end – 2 nos 	
3.	STATCOM (2x±300MVAR) along with MSC (4x125 MVAR) & MSR (2x125 MVAR) at Siwani S/s	
4.	Siwani – Sonipat (PG) 400 kV D/c line (Quad) along with 63 MVAR switchable line reactor for each circuit at Siwani S/s end <ul style="list-style-type: none"> • 420 kV, 63 MVAR switchable line reactors at Siwani S/s end– 2 nos. • Switching equipment for 420kV, 63 MVAR switchable line reactors at Siwani S/s end – 2 nos. 	
5.	Siwani – Jind (PG) 400 kV D/c line (Quad)	
6.	2 nos. 400 kV line bays each at Jind(PG) & Sonipat (PG) S/s <ul style="list-style-type: none"> • 400 kV line bays at Jind (PG) S/s – 2 nos. • 400 kV line bays at Sonipat (PG) S/s – 2 nos. 	
7.	2 nos. 765 kV line bays at Bikaner-IV PS <ul style="list-style-type: none"> • 765 kV line bays at Bikaner-IV PS – 2 nos. 	

Note: 1. POWERGRID shall provide space for 2 Nos. of 400 kV line bays each at Jind (PG) and Sonipat (PG) S/s.

2. Developer of Bikaner-IV PS shall provide space for 2 Nos. of 765 kV line bays.

Project Description

Transmission scheme for evacuation requirement of additional 6 GW RE potential from Bikaner Complex (Bikaner-IV) has been evolved.

As part of the above comprehensive scheme, 765/400/220 kV Bikaner-IV PS is being established for RE injection along with its 400 kV D/C interconnections to Bikaner-II PS and Bikaner-III PS (through LILO). For onwards evacuation of power from Bikaner-IV PS, 765/400 kV Siwani S/s is being established along with 765 kV interconnections with Bikaner-IV PS through 2xD/C lines. For further dispersal of power towards load centers, 400 kV D/C interconnections with Jind (PG), Sonipat (PG), Patran (Indi Grid) and Fatchabad (PG) S/s are also being implemented.

Transmission Service Agreement

The subject transmission scheme i.e. from Rajasthan REZ Ph-IV (Part-3: 6GW) [Bikaner complex] : Part-B involves establishment of 765/400/220 kV Siwani S/s and its 765 kV D/C (2nd) interconnections to Bikaner-IV PS. Siwani S/s is being interconnected with Jind (PG) and Sonipat (PG) S/s through 400 kV D/C lines. STATCOM (2x±300MVAR) along with MSC/MSR at Siwani S/s is also being implemented as part of the above scheme.

The above transmission scheme was agreed in the 27th CMETS-NR meeting held on 10.01.2024 and 71st NRPC meeting held on 29.01.2024. Transmission System was further agreed in 18th National Committee on Transmission (NCT) held on 05.03.2024. Subsequently, Ministry of Power, Government of India, vide its Gazette Notification CG-DL-E-15032024-253080 dated 15.03.24 declared establishment of Transmission system for evacuation of power from Rajasthan REZ Ph-IV (Part-3: 6GW) [Bikaner complex]: Part-B through tariff based competitive bidding process route.

SPECIFIC TECHNICAL REQUIREMENTS FOR TRANSMISSION LINE

- A.1.0 The design, routing and construction of transmission lines shall be in accordance with Chapter V, Part-A of CEA (Technical Standards for Construction of Electrical Plants and Electric Lines) Regulations 2022, as amended from time to time. Other CEA Regulations and MoP guidelines, as applicable, shall also be followed.
- A.2.0 Selection of tower type shall be made as per CEA Regulations, however in case lattice type towers are used, the following shall also be applicable:
- A.2.1 Steel section of grade E 250 and/or grade E 350 as per IS 2062, only are permitted for use in towers, extensions, gantry structures and stub setting templates. For towers in snowbound areas, steel sections shall conform to Grade-C of IS-2062.
- A.2.2 Towers shall be designed as per IS-802:2015, however the drag coefficient of the tower shall be as follows: -

Solidity Ratio	Drag Coefficient
Up to 0.05	3.6
0.1	3.4
0.2	2.9
0.3	2.5
0.4	2.2
0.5 and above	2.0

- A.3.0 Transmission Service Provider (TSP) shall adopt any additional loading/design criteria for ensuring reliability of the line, if so desired and /or deemed necessary.
- A.4.0 Transmission line shall be designed considering wind zones as specified in wind map given in National Building Code 2016, Vol.1. The developer shall also make his own assessment of local wind conditions and frequent occurrences of high intensity winds (HIW) due to thunderstorms, dust-storms, downburst etc. along the line route and wherever required, higher wind zone than that given in wind map shall be considered for tower design for ensuring reliability of line. Further, for transmission line sections passing within a distance of 50 km from the boundary of two wind zones, higher of the two wind zones shall be considered for design of towers located in such sections.
- A.5.0 Selection of reliability level for design of tower shall be as per CEA Regulation (Technical Standards for Construction of Electrical Plants and Electric Lines) Regulations 2022, as amended from time to time.
- A.6.0 A) For power line crossing of 400 kV or above voltage level, large angle and dead end towers (i.e. D/DD/QD) shall be used on either side of power line crossing.

B) For power line crossing of 132 kV and 220 kV voltage level, angle towers (B/C/D/DB/DC/DD/ QB/QC/QD) shall be used on either side of power line crossing depending upon the merit of the prevailing site condition and line deviation requirement.

C) For power line crossing of 66 kV and below voltage level, suspension/tension towers shall be provided on either side of power line crossing depending upon the merit of the prevailing site condition and line deviation requirement.

D) For crossing of railways, national highways and state highways, the rules/regulations of appropriate authorities shall be followed.

A.7.0 (a) The relevant conductor configuration shall be as follows: -

Name of line: **Bikaner-IV PS – Siwani 765 kV D/C (2nd) line**

Type of conductor: ACSR / AAAC / AL59

Basic parameters:

Transmission line	ACSR Conductor specified	Equivalent AAAC conductor based on 53.5% conductivity of Al Alloy	Equivalent minimum size of AL59 conductor based on 59% conductivity of AL Alloy*	Sub-conductor Spacing
765 kV D/C (Hexa Bundle) Transmission Lines	Zebra: Stranding 54/3.18 mm-Al + 7/3.18 mm-Steel, 28.62 mm diameter 428 mm ² , Aluminium area, Maximum DC Resistance at 20°C (Ω/km): 0.06868 Minimum UTS: 130.32	Stranding details: 61/3.19 mm, 28.71 mm diameter. 487.5 mm ² Aluminium alloy area Maximum DC Resistance at 20°C (Ω/km) : 0.06815 Minimum UTS: 135.6 kN	Stranding details: 61/3.08 mm, 27.72 mm diameter. 454 mm ² Aluminium alloy area Maximum DC Resistance at 20°C (Ω/km) : 0.0653 Minimum UTS: 108 kN	457 mm

Transmission line	ACSR Conductor specified	Equivalent AAAC conductor based on 53.5% conductivity of Al Alloy	Equivalent minimum size of AL59 conductor based on 59% conductivity of AL Alloy*	Sub-conductor Spacing
	kN			

(b) The relevant conductor configuration of below lines shall be as follows: -

(i) Siwani – Sonipat (PG) 400 kV D/C line (Quad)

(ii) Siwani – Jind (PG) 400 kV D/C line (Quad)

Type of conductor: ACSR / AAAC / AL59

Basic parameters:

Transmission line	ACSR Conductor specified	Equivalent AAAC conductor based on 53% conductivity of Al Alloy	Equivalent minimum size of AL59 conductor based on 59% conductivity of AL Alloy*	Sub-conductor Spacing
400 kV D/C (Quad Bundle) transmission lines	<p>Moose: Stranding 54/3.53 mm-Al + 7/3.53 mm-Steel, 31.77 mm diameter 528.5 mm², Aluminium area,</p> <p>Maximum DC Resistance at 20°C (Ω/km):</p>	<p>Stranding details: 61/3.55 mm 31.95 mm diameter; 604 mm² Aluminium alloy area</p> <p>Maximum DC Resistance at 20°C (Ω/km): 0.05506</p>	<p>Stranding details: 61/3.31 mm 29.79 mm diameter; 525 mm² Aluminium alloy area</p> <p>Maximum DC Resistance at</p>	457 mm

Transmission line	ACSR Conductor specified	Equivalent AAAC conductor based on 53% conductivity of Al Alloy	Equivalent minimum size of AL59 conductor based on 59% conductivity of AL Alloy*	Sub-conductor Spacing
	0.05552 Minimum UTS: 161.20 kN	Minimum UTS: 159.80 kN	20°C (Ω/km): 0.0566 Minimum UTS: 124.70 kN	

Note:

- *To select any size above the minimum, the sizes mentioned in the Indian standard IS-398(part-6) shall be followed.*
- The transmission lines shall have to be designed for a maximum operating conductor temperature of 85 deg C.*

A.8.0 The required phase to phase spacing and horizontal spacing for 765 kV and 400 kV line(s) shall be governed by the tower design as well as minimum live metal clearances for 765 kV and 400 kV voltage level under different insulator swing angles. However, the phase to phase spacing for 765 kV and 400 kV lines shall not be less than 15 m and 8 m respectively.

A.9.0 All electrical clearances including minimum live metal clearance, ground clearance and minimum mid span separation between earth wire and conductor as given below shall be considered:

I. Minimum live metal clearances for 765 kV line:a) (i) Under stationary conditions

From tower body: For 765 kV D/C: 6.1 m

For 765 kV S/C: 5.6 m

(ii) Under swing conditions

Wind Pressure Condition	Minimum Electrical Clearance
a) Swing angle (25°)	4.4 m
b) Swing angle (55°)	1.3 m

- b) Minimum ground clearance for 765 kV: 18 m
- c) Minimum mid span separation between earthwire and conductor for 765 kV: 9.0 m

II. Minimum live metal clearances for 400 kV line:

- a) (i) Under stationary conditions:
From tower body: 3.05 m
- (ii) Under Swing conditions

Wind Pressure Condition	Minimum Electrical Clearance
a) Swing angle (22°)	3.05 m
b) Swing angle (44°)	1.86 m

- b) Minimum ground clearance for 400 kV: 8.84 m
- c) Minimum mid span separation between earthwire and conductor for 400 kV: 9.0 m

- A.10.0 Shielding angle shall not exceed 10 deg for 765 kV D/C and 20 deg for 400 kV transmission line.
- A.11.0 The Fault current for design of line shall be 50 kA for 1 sec for 765 kV and 63 kA for 1 sec for 400 kV.
- A.12.0 In case of 765 kV and 400 kV voltage class lines, at least one out of two earth wires shall be OPGW and second earth wire, if not OPGW, shall be either of Galvanized Stranded Steel (GSS) or Aluminum Alloy Conductor Steel Reinforced (AACSR) conductor type or any other suitable conductor type depending upon span length and other technical consideration.
- A.13.0 Each tower shall be earthed such that tower footing impedance does not exceed 10 ohm. Pipe type or Counterpoise type earthing shall be provided in accordance with relevant IS. Additional earthing shall be provided on every 7 to 8 kms distance for direct earthing of both shield wires. If site condition demands, multiple earthing or use of earthing enhancement compound shall be used.
- A.14.0 Pile type foundation shall be used for towers located in river or creek bed or on bank of river having scourable strata or in areas where river flow or change in river course is anticipated, based on detailed soil investigation and previous years' maximum flood discharge of the river, maximum velocity of water, highest flood level, scour depth and

anticipated change in course of river based on river morphology data of at least past 20 years to ensure availability and reliability of the transmission line.

- A.15.0 Transmission line route shall be finalized, in consultation with appropriate authorities so as to avoid the habitant zones of endangered species and other protected species. Bird diverters, wherever required, shall be provided on the line. In order to optimize the route use of GATISHAKTI platform shall also be made.
- A.16.0 Wherever, transmission lines are passing through cyclone prone areas (i.e. areas up to 60 km from coast)/ creek regions/ aggressive soil areas following shall also be applicable:
- a) The fabricated tower parts and stubs shall have a minimum overall zinc coating of 900 g/m² of surface area except for plates and sections below 5 mm which shall have a minimum overall zinc coating of 610 g/ m² of surface area. The average zinc coating for all sections and plates 5 mm and above shall be maintained as 127 microns and that for plates and sections below 5 mm shall be maintained as 87 microns.
 - b) Ready mix concrete of M30 Grade shall be used to avoid use of locally available saline water. However, design mix concrete of M30 Grade conforming to IS 456 with potable water can be used at locations where transportation of ready-mix concrete is not feasible. Minimum cement content in any case shall not be less than 330 kg/m³.
 - c) The surface of the reinforced steel shall be treated with epoxy-based coating to enhance corrosion performance of foundation. Use of epoxy coated reinforcement in foundation shall be as per IS 13620. In addition, two (2) coats of bituminous painting of minimum 1.6 kg/m² per coat shall be applied on all exposed faces of foundation (i.e. pedestal and base slab).
 - d) Double coat 20 mm thick cement plaster shall be provided on all exposed concrete surface as well up to 300 mm below ground level to give protection to concrete surface from environmental and saline effect.
 - e) Before coping of chimney top portion, three coats of anti-corrosive paint of minimum 30-35 microns dry film thickness each shall be applied on the stub in the 50 mm coping portion as well as up to 350 mm above CL portion.
- A.17.0 The raised chimney foundation is to be provided in areas prone to flooding/water stagnation like paddy field /agricultural field and undulated areas to avoid direct contact of water with steel part of tower. The top of the chimney of foundation should be at least above HFL (High Flood Level) or the historical water stagnation/ logging level (based on locally available data) or above High Tide Level or 500 mm above Natural Ground level (whichever is higher).

- A.18.0 Routing of transmission line through protected areas of India shall be avoided to the extent possible. In case, it is not possible to avoid protected areas, the towers of the transmission line up to 400 kV level which are installed in protected areas shall be designed for Multi-circuit (4 circuits) configuration of same voltage level considering reliability level of at least two (2). The top two circuits of these multi-circuit towers shall be used for stringing of the transmission line under present scope and the bottom two circuits shall be made available for stringing of any future transmission line of any transmission service providers/ State transmission utilities/Central transmission utilities passing through the same protected area. Further, the configuration and coordinates of such transmission towers shall be submitted to CEA, CTU and BPC by the TSP.
- A.19.0 The TSP shall abide by the Guidelines of CEA w.r.t. shifting of transmission lines for NHAI projects and other projects.
- A.20.0 Safety precautions in regard to gas/oil pipelines in vicinity of Transmission lines shall be taken in coordination with gas/ petroleum authorities.

SPECIFIC TECHNICAL REQUIREMENTS FOR SUBSTATION

The proposed **new 765/400 kV substation at Siwani (AIS)** generally conforms to the requirements of CEA (Technical Standards for Construction of Electrical Plants and Electric Lines) Regulations 2022, as amended from time to time.

Extension of 765 kV Bikaner-IV substation shall be conventional AIS type generally conforming to the requirements of CEA (Technical Standards for Construction of Electrical Plants and Electric Lines) Regulations 2022, as amended from time to time.

Extension of 400 kV Sonipat (PG), 400 kV Jind (PG) substation shall be conventional AIS type generally conforming to the requirements of CEA (Technical Standards for Construction of Electrical Plants and Electric Lines) Regulations 2022, as amended from time to time.

Other CEA Regulations/guidelines as amended up to date and MoP guidelines, as applicable, shall also be followed.

B.1.0 Salient features of Substation Equipment and Facilities

The design and specification of substation equipment are to be governed by the following factors:

B.1.1 Insulation Coordination

The system design parameters for substations/switchyards shall be as given below:

Sl. No.	Description of parameters	765/400 kV Siwani S/s		Extn. of 400 kV Sonipat (PG)/ Jind (PG)	Extn. of 765 kV Bikaner-IV S/s
		765 kV System	400 kV System	400 kV System	765 kV System
1.	System operating voltage	765 kV	400 kV	400 kV	765 kV
2.	Maximum voltage of the system (rms)	800 kV	420 kV	420 kV	800 kV
3.	Rated frequency	50 Hz	50 Hz	50 Hz	50 Hz
4.	No. of phases	3	3	3	3
5.	Rated Insulation levels				
i)	Lightning Impulse withstand voltage for				

Sl. No.	Description of parameters	765/400 kV Siwani S/s		Extn. of 400 kV Sonipat (PG)/ Jind (PG)	Extn. of 765 kV Bikaner-IV S/s
		765 kV System	400 kV System	400 kV System	765 kV System
	(1.2/50 micro sec.) - for Equipment other than Transformer and Reactor - for Insulator String	2100 kVp 2100 kVp	1425 kVp 1550 kVp	1425 kVp 1550 kVp	2100 kVp 2100 kVp
ii)	Switching impulse withstand voltage (250/2500 micro sec.) dry and wet	1550 kVp	1050 kVp	1050 kVp	1550 kVp
iii)	One-minute power frequency dry withstand voltage (rms)	830 kV	630 kV	630 kV	830 kV
6.	Corona extinction voltage	508 kV	320 kV	320 kV	508 kV
7.	Max. radio interference voltage for frequency between 0.5 MHz and 2 MHz	2500 micro-volts at 508 kV rms	1000 micro-volts at 266 kV rms	1000 micro-volts at 266 kV rms	2500 micro-volts at 508 kV rms
8.	Minimum creepage distance for insulator string/ longrod insulators/ outdoor bushings	24800 mm (31 mm/ kV)	13020 mm (31 mm/ kV)	13020 mm (31 mm/ kV)	24800 mm (31 mm/ kV)
9.	Minimum creepage distance for switchyard equipment	20000 mm (25 mm/ kV)	10500 mm (25 mm/ kV)	10500 mm (25 mm/ kV)	20000 mm (25 mm/ kV)
10.	Max. fault current	50 kA	63 kA	63 kA	50 kA
11.	Duration of fault	1 sec	1 Sec	1 Sec	1 sec

B.1.2 Switching Scheme

The switching schemes, as mentioned below, shall be adopted at various voltage levels of substation/switchyard:

Notes: -

- i) *For one and half breaker switching scheme, any double circuit line consisting of two numbers of feeders and originating from the same transmission or generating switchyard shall not be terminated in one diameter.*
- ii) *Two transformers of same HV rating shall not be connected in the same diameter and similarly, two bus reactors of same HV rating shall also not be connected in the same diameter.*
- iii) *400 kV Bus Sectionalizers shall be placed such that each section shall have even distribution of Poles, ICT, Feeders and filter bank(s)/sub-bank(s) so as to have maximum operational flexibility.*
- iv) *A diameter in one and half breaker scheme is a set of 3 circuit breakers with associated isolators, earth switches, current transformers etc. for controlling 2 (two) numbers of feeders.*
- v) *Connection arrangement of Switchable Line reactors shall be such that it can be used as Line reactor as well as Bus reactor with suitable NGR bypass arrangement. Further, Spare 1-phase Shunt Reactor unit along with required 1-phase circuit breaker shall be placed and connected in such a way that the spare unit can be utilized for all the bus and switchable line reactor banks (including future reactor banks) without its physical movement.*
- vi) *One (1) set of bus sectionalizer for 400 kV shall comprise 2 Nos. of bus sectionalizer bays with associated Circuit Breakers, Isolators and Current Transformers for both Main-I and Main-II buses.*
- vii) *TSP shall plan distribution of line and transformer feeders to bus bar in such a way that all power can be evacuated successfully without crossing the thermal limit at any point of bus bar.*

viii) Siwani S/s:

400 kV Bus Sections shall be provided with the following feeder distribution.

400 kV Bus Section-1	400 kV Bus Section-2
a) 3 Nos. of 765/400 kV ICT bay	a) 3 Nos. of 765/400 kV ICT

<p>b) 2 Nos. 400 kV Line (for Siwani - Jind/ Sonipat D/C line)</p> <p>c) 1 No. Bus Reactor</p> <p>d) 1 No. STATCOM</p> <p>e) Provision for 2 Nos. 400 kV Line (for upcoming Siwani -Fatehabad/ Patran D/C line)</p> <p>f) Provision for 1 No. Future Bus Reactor</p>	<p>b) 2 Nos. 400 kV Line (for Siwani - Jind/ Sonipat D/C line)</p> <p>c) 1 No. Bus Reactor</p> <p>d) 1 No. STATCOM</p> <p>e) Provision for 2 Nos. 400 kV Line (for upcoming Siwani -Fatehabad/ Patran D/C line)</p>
--	---

In line with the above feeder distribution, three (03) number full diameters and one (01) number half diameters (with associated tie bay) shall be provided in each 400 kV Sections. In half diameters, one circuit of upcoming each Fatehabad and Patran D/C transmission line shall be terminated under “Transmission system for evacuation of power from Rajasthan REZ Ph-IV (Part- 3:6 GW) [Bikaner complex]: Part-A.

Bay configuration at 765 kV yard of Siwani S/s shall be provided such that one feeder in a diameter shall be terminated to an ICT and other shall be terminated to lines /Bus Reactor. Accordingly, 04 Nos. complete diameter and 02 Nos. half diameter (consisting of Main and associated Tie bays) with a provision of 02 Nos. future bays (for terminating 765 kV Bikaner-IV to Siwani D/C line) shall be under present scope.

ix) **Extension of Sonipat (PG) S/s:**

For termination of Siwani- Sonipat 400 kV D/C transmission line at Sonipat S/s, one circuit shall be terminated in new half diameter (consisting of Main and associated Tie Bay) and other circuit shall be terminated in existing diameter where tie bay shall be available at Sonipat S/s. Further, all associated interconnection work shall also be in the present scope of TSP. Bidder shall refer the Single Line Diagram (SLD) and General Arrangements (GA) drawing of the substation provided with the RfP.

x) **Extension of Jind (PG) S/s:**

For termination of Siwani- Jind 400 kV D/C line at Jind S/s, both circuits shall be terminated in existing diameter where tie bays shall be available at Jind S/s. Further, all associated interconnection work shall also be in the present scope of TSP. Bidder shall refer the Single Line Diagram (SLD) and General Arrangements (GA) drawing of the substation provided with the RfP.

xi) **Extension of Bikaner-IV S/s:**

For termination of 765 kV Bikaner-IV to Siwani (2nd) D/C line at Bikaner-IV S/s, 02 Nos. tie bays shall be available for termination of both circuits at Bikaner-IV S/s. (These Tie bays are in the scope of developer of “Transmission system for evacuation of power from Rajasthan REZ Ph-IV (Part- 3:6 GW) [Bikaner complex]: Part-A”). Further, all associated interconnection work shall also be in the present scope of TSP..

B.2.0 Substation Equipment and facilities :

The switchgear shall be designed and specified to withstand operating conditions and duty requirements. All equipment shall be designed considering the following capacity.

Sl. No	Description of bay	765/400 kV Siwani S/s		Extn. of 765 kV Bikaner-IV S/s
		765 kV	400 kV	765 kV
1.	Bus Bar	4000 A	4000 A	4000 A
2.	Line bay	3150 A	3150 A	3150 A
3.	ICT bay	3150 A	3150 A	--
4.	Bus Reactor Bay	3150 A	3150 A	--
5.	Switched Line Reactor Bay	3150 A	3150 A	3150 A
6.	STATCOM bay	--	3150 A	--
7.	Bus Sectionalizer Bay	--	4000 A	--

Sl. No	Description of bay	Extn. of 400 kV Sonipat (PG)	Extn. of 400 kV Jind (PG) S/s
		400 kV	400 kV
1.	Bus Bar	Existing	Existing
2.	Line bay	3150 A	3150 A

B.2.1 (765/√3)/ (400/√3)/ 33 kV, Single Phase Autotransformer

500 MVA, (765/√3)/ (400/√3)/33 kV, 1-phase Autotransformer (including arrangement for 3-phase bank formation of 1500 MVA) shall conform to CEA’s “Standard Specifications and Technical Parameters for Transformers and Reactors (66 kV and above Voltage Class)” available on CEA website and as amended up to date.

Spare 1-phase Transformer unit shall be placed and connected in such a way that in case of fault in any unit of any of the transformer banks (including for future transformer banks) can be replaced by spare unit without physically moving it.

B.2.2 (765/ $\sqrt{3}$) kV, Single Phase Shunt Reactor

80 MVAR, 765/ $\sqrt{3}$ kV, 1-Phase Reactor (including arrangement for 3-phase bank formation of 240 MVAR) shall conform to CEA's "Standard Specifications and Technical Parameters for Transformers and Reactors (66 kV and above Voltage class)" available on CEA website and as amended up to date.

Spare 1-phase Shunt Reactor unit shall be placed and connected in such a way that the spare unit can be utilized for all the bus and switchable line reactor banks (including for future reactor banks) without its physical movement.

The resistive value of NGR for each circuit at each end of Bikaner-IV PS – Siwani 765 kV D/C (2nd) line shall be 450 ohm.

Neutral Grounding Reactor and Surge Arrester for 765 kV Switchable Line Reactors (as applicable):

The neutral of the switchable line reactors (wherever provided) shall be grounded through adequately rated Neutral Grounding Reactors (NGR) to facilitate single phase auto-reclosure, provided that the NGR shall be provided with suitable bypass arrangement so that the switchable line reactor can be used as Bus Reactor as and when required. The neutral of bus reactor shall be solidly grounded.

NGR shall be oil filled or dry type air core for outdoor application. NGR shall conform to CEA's "Standard Specifications and Technical Parameters of Transformers and Reactors (66 kV and above Voltage Class)" as amended up to date. Technical parameters of NGR shall be as specified in Annexure-A of above-mentioned document.

The surge arresters (rated voltage of arrester in co-ordination with ohmic value of NGR shall be decided by the TSP) shall be provided and physically located between the neutral of shunt reactor (brought out at 145 kV class bushing) and neutral grounding reactor. The surge arresters shall be of heavy duty station class gapless Metal oxide (ZnO) type conforming in general to IEC-60099-4. Surge Arresters shall be hermetically sealed units, of self-supporting construction, suitable for mounting on structures.

B.2.3 420 kV, 3-phase, Shunt Reactor

63 MVAR, 420 kV, 3-Phase Reactor shall conform to CEA's "Standard Specifications and Technical Parameters for Transformers and Reactors (66 kV and above Voltage Class)" available on CEA website and as amended up to date.

The resistive value of NGR for each circuit at Siwani end of 400 kV D/C Siwani-Sonipat line shall be 350 Ohm.

B.2.4 765 kV and 400 kV AIS Substation equipment (as applicable)

B.2.4.1 Circuit Breakers (AIS)

The circuit breakers and accessories shall conform to IEC: 62271-100, IEC: 62271-1 and shall be of SF6 Type. The circuit breakers shall be of class C2-M2 (as per IEC) with regard to restrike probability during capacitive current breaking and mechanical endurance. The rated break time shall not exceed 40 ms for 765 kV and 400 kV circuit breakers. The 765 kV and 400 kV Circuit breakers shall be provided with single phase and three phase auto reclosing. Each breaker would have two sets of trip circuits which would be connected to separate DC supplies for greater reliability. The Circuit breakers controlling 765 kV lines shall be provided either with pre-insertion closing resistor of about 450 ohm maximum with 9 ms insertion time or with Controlled Switching Device. The Circuit breakers controlling 400 kV lines shall be provided with pre insertion closing resistor of about 400 ohm with 8 ms insertion time or Controlled Switching Device (CSD) for lines longer than 200 km. The short line fault capacity shall be same as the rated capacity and this is proposed to be achieved without use of opening resistors. The controlled switching device shall be provided in Circuit breakers of switchable line reactor and in Main and Tie circuit breakers of line with non-switchable line reactors and Bus reactors and 765/400 kV Transformers.

B.2.4.2 Isolators (AIS)

The isolators shall comply with IEC 62271-102 in general. 765 kV Isolator design shall be double break or vertical break or knee-type. 400 kV Isolators shall be double break type. All Isolators and earth switches shall be motor operated. Earth switches shall be provided at various locations to facilitate maintenance. Isolator rated for 400 kV shall be of extended mechanical endurance class - M2 as per IEC-62271-102. Main blades and earth blades shall be interlocked and interlock shall be fail safe type. 765 kV and 400 kV earth switches for line isolator shall be suitable for induced current switching duty as defined for Class-B.

B.2.4.3 Current Transformers (AIS)

Current Transformers shall comply with IEC 61869 in general. All ratios shall be obtained by secondary taps only. Generally, Current Transformers (CT) for 765 kV and 400 kV shall have six cores (four for protection and two for metering). The burden and knee point voltage shall be in accordance with the requirements of the system including possible feeds for telemetry. The accuracy class for protection core shall be PX and for metering core it shall be 0.2S. The rated burden of cores shall be closer to the maximum burden requirement of metering and protection system (not more than 20 VA for metering core) for better sensitivity and accuracy. The instrument security factor shall be less than 5 for CTs up to 400 kV and less than 10 for CTs of 765 kV voltage class.

B.2.4.4 Capacitive Voltage Transformers (AIS)

Capacitive Voltage transformers shall comply with IEC 61869 in general. These shall have three secondaries out of which two shall be used for protection and one for metering. The accuracy class for protection cores shall be 3P and for metering core shall be 0.2. The Capacitive voltage transformers on lines shall be suitable for Carrier Coupling. The Capacitance of CVT for 400 kV shall be of 4400/ 8800 pF depending on PLCC requirements whereas the Capacitance of CVT for 765 kV shall be 8800 pF. The rated burden of cores shall be closer to the maximum burden requirement of metering and protection system (not more than 50 VA for metering core) for better sensitivity and accuracy.

B.2.4.5 Surge Arresters (AIS)

624 kV and 336 kV Station High (SH) duty gapless type Surge arresters with thermal energy (W_{th}) of minimum 13 kJ/kV and 12 kJ/kV conforming to IEC 60099-4 in general shall be provided for 800 kV and 420 kV systems respectively. Other characteristics of Surge arrester shall be chosen in accordance with system requirements. Surge arresters shall be provided near line entrances, near Transformer and Reactor so as to achieve proper insulation coordination. Surge Arresters shall be provided with porcelain/ polymer housing fitted with pressure relief devices. A leakage current monitor with surge counter shall be provided with each surge arrester.

B.2.5 Protection Relaying and Control System

The protective relaying system proposed to be provided for transmission lines, auto-transformers, reactors and bus bars to minimize the damage to the equipment in the events of faults and abnormal conditions, is dealt within this section. All main protective relays shall be numerical type with IEC 61850 communication interface and should have interoperability during integration of numerical relays to communicate over IEC 61850

protocol with RTU/ SAS/ IEDs of different OEMs. All numerical relays shall have built in disturbance recording feature.

The protection circuits and relays of the transformer and reactor shall be electrically and physically segregated into two groups each being independent and capable of providing uninterrupted protection even in the event of one of the protection groups failing, to obtain redundancy, and to take protection systems out for maintenance while the equipment remains in service.

a) Transmission Lines Protection

765 kV and 400 kV lines shall have Main-I numerical three zone distance protection scheme with carrier-aided inter-tripping feature. 765 kV and 400 kV lines shall also have Main-II numerical distance protection schemes like Main-I but from a different make that of Main-I. The Main-I and Main-II protection relays of the same make may be provided only if they are of different hardware and manufacturing platforms or have different principles of operation.

However, Line Current Differential relay (with back up distance protection feature) as Main-I and Main-II shall be considered at both ends for short lines (line length below 30 km) having Fibre Optic Communication Link. Differential relay at the remote end shall be provided by the TSP. Associated power and control cabling and integration with SAS at the remote end shall be provided by the respective bay owner.

In case of loop in loop out of transmission lines, the existing protection scheme shall be studied and suitable up-gradation (if required) shall be carried out.

Further, all 765 kV and 400 kV lines shall be provided with single and three phase auto-reclosing facilities to allow reclosing of circuit breakers in case of transient faults. These lines shall also be provided with distance to fault locators to identify the location of faults on transmission lines.

All 765 kV and 400 kV lines shall also be provided with two stages over voltage protection. Over voltage protection and distance to fault locator may be provided as in-built features of Main-I & Main-II protection relays. Auto reclose as built-in function of Bay Control Unit (BCU) is also acceptable.

The Main-I and Main-II protection relays shall be fed from separate DC sources and shall be mounted in separate panels.

For 765 kV and 400 kV transmission lines, directional IDMT earth fault relay should be provided as a standalone unit or in-built feature of Main-I and Main -II feature.

b) Auto Transformer Protection

These shall have the following protections:

- i) Numerical Differential protection
- ii) Numerical Restricted earth fault protection
- iii) Numerical Back-up Over-current and earth fault protection on High Voltage (HV) and Intermediate Voltage (IV) side
- iv) Numerical Over fluxing protection on HV and IV side
- v) Numerical Overload alarm

Further, Numerical Back-up Over-current and earth fault protection on HV and IV side of autotransformer shall not be combined with other protective functions in the main relays and shall be independent relays. Besides these, power transformers shall also be provided with Buchholz relay, Magnetic Oil Gauge (MOG) with low oil level alarm, protection against high oil and winding temperature and pressure relief device etc.

Suitable monitoring, control (operation of associated circuit breaker and isolator) and protection for LT auxiliary transformer connected to tertiary winding of auto-transformer for the purpose of auxiliary supply shall be provided. The over current and other necessary protection shall be provided for the auxiliary transformer. These protection and control may be provided as built in feature either in the bay controller to be provided for the auxiliary system or in the control and protection IEDs to be provided for autotransformer.

C) 765 kV and 400 kV Reactor Protection

Reactor shall be provided with the following protections:

- i) Numerical Differential protection.
- ii) Numerical Restricted earth fault protection
- iii) Numerical Back-up impedance protection

Besides these, reactors shall also be provided with Buchholz relay, Magnetic Oil Gauge (MOG) with low oil level alarm, protection against oil and winding temperatures and pressure relief device, etc.

d) Bus bar Protection

The high-speed low impedance type bus bar differential protection, which is essential to minimize the damage and maintain system stability at the time of bus bar faults, shall be

provided for 765 kV and 400 kV buses. Duplicated bus bar protection is envisaged for 765 kV and 400 kV bus-bar protection. Bus bar protection scheme shall be such that it operates selectively for each bus and incorporates necessary features required for ensuring security. The scheme shall have complete bus bar protection for present as well as future bays envisaged i.e. input / output modules for future bays shall also be provided.

Bus Bar protection system for new substation shall be de-centralized (distributed) type. In case, the bus section is provided, then each side of bus section shall have separate set of bus bar protection schemes.

For existing substations, the existing bus bar protection shall be augmented as per requirement

e) Local Breaker Back up Protection

This shall be provided for each 765 kV and 400 kV circuit breakers and will be connected to de-energize the affected stuck breaker from both sides.

Notes:

- 1. LBB and REF relays shall be provided separately from transformer differential relay.*
- 2. LBB relay may also be provided as built-in protection function of distributed bus bar protection scheme; however, in such case separate LBB relay shall be provided for tie bays (in case of One and Half breaker scheme).*
- 3. Over fluxing and overload protection can be provided as built-in feature of differential relay.*
- 4. In 765 kV and 400 kV switchyard, if spare bay of half diameter is identified as future, Tie CB relay panel shall be with Auto-reclosure feature.*

B.2.6 Substation Automation System

- a)** For all the new substations, a state-of-the-art Substation Automation System (SAS) conforming to IEC-61850 shall be provided. The distributed architecture shall be used for Substation Automation system, where the controls shall be provided through Bay control units. The Bay control unit is to be provided bay-wise for voltage levels 400 kV and above. All bay control units as well as protection units are normally connected through an Optical fibre high-speed network. The control and monitoring of circuit breaker, dis-connector, re-setting of relays etc. can be done from Human Machine Interface (HMI) in the Control room.

The functions of control, annunciation, disturbance recording, event logging and measurement of electrical parameters shall be integrated in the Substation Automation System.

At new substations, the Substation Automation System (SAS) shall be suitable for the operation and monitoring of the complete substation including proposed future bays/elements.

In existing substations with a Substation automation system (SAS), augmentation of existing SAS shall be done for bays under the present scope.

In existing Substations where Substation automation is not provided, control functions shall be done through control panels.

Necessary gateway and modems (as required) shall be provided to send data to RLDC/SLDC as per their requirement. Any augmentation work at RLDC/SLDC is excluded from TSP's scope. However, all the configuration work at the substation end required to send data to RLDC/SLDC shall be in the scope of TSP.

b) Time synchronization equipment

Time synchronization equipment complete in all respects including antenna, cable and processing equipment required to receive time signal through GPS or from National Physical Laboratory (NPL) through INSAT shall be provided at new substations. This equipment shall be used to synchronize SAS and IEDs etc.

B.3.0 Substation Support Facilities

Certain facilities required for the operation and maintenance of substations as described below shall be provided at the new substation. In existing substation, these facilities have already been provided and will be extended/ augmented as per requirement.

B.3.1 AC and DC power supplies

For catering the requirements of three phase and single-phase AC supply and DC supply for various substation equipment (for present and future scope), the following arrangement is envisaged: -

- (i) For LT Supply at each new Substation, two (2) Nos. of LT Transformers (minimum 800 kVA for substations with highest voltage rating as 765 kV) shall be provided which shall be fed from two independent sources as per the CEA (Technical Standards for Connectivity to the Grid) Regulations, 2007.

Metering arrangement with Special Energy Meters (SEMs) shall be provided by TSP at 33 kV tertiary of Transformer for drawing auxiliary supply at new substation. Such SEMs shall be provided by CTU at the cost of the TSP. Accounting of such energy drawn by the TSP shall be done by RPC as part of Regional Energy Accounting.

Additionally, Active Energy Meters may be provided at the same point in the 33 kV tertiary of Transformer by local SEB/ DISCOM for energy accounting.

- (ii) 2 sets of 220 V battery banks for control and protection and 2 sets of 48 V battery banks for PLCC/ communication equipment shall be provided at each new Substation. Each battery bank shall have a float-cum-boost charger.

At new substation, sizing of 220 V battery and battery charger shall be done based on the number of bays specified (including future bays) as per CEA Regulations and relevant IS. Two (2) sets of 48 V battery banks for PLCC and communication equipment for present and future scope shall be provided at each new Substation with at least 10-hour battery backup and extended backup, if required. 48 V DC can be achieved from 220 V DC battery bank using adapter, if so desired by TSP, without compromising backup time.

- (iii) Suitable AC and DC distribution boards and associated LT Switchgear shall be provided at new substation.

For new substation, following switch boards shall be considered with duplicate supply with bus coupler/ sectionalizer and duplicate outgoing feeders except for Emergency lighting distribution board which shall have only one incoming feeder:

- (a) 415 V Main Switch board – 1 No.
- (b) AC distribution board – 1 No.
- (c) Main lighting distribution board – 1 No.
- (d) Emergency lighting distribution board – 1 No.
- (e) 220 Volt DC distribution board – 2 Nos.
- (f) 48 Volt DC distribution board – 2 Nos.

Sizing of LT Switchgear shall be suitable to cater the requirement for all present and future bays. AC and DC distribution boards shall have equipped modules for all the feeders (including future as specified).

- (iv) At new Substation, one No. of DG set (minimum 500 kVA for substations with highest voltage rating as 765 kV) shall be provided for emergency applications.
- (v) At new substation, sizing of battery and battery charger shall be done based on the number of bays specified (including future bays).
- (vi) For substation extensions, existing facilities shall be augmented as required.

B.3.2 Fire Fighting System

Fire-fighting system for substation including Transformer and Reactor shall conform to CEA (Measures Relating to Safety and Electric Supply) Regulations, 2023 as amended from time to time.

Further, adequate water hydrants and portable fire extinguishers shall be provided in the substations. The main header of the firefighting system shall be suitable for extension to bays covered under the future scope; necessary piping interface in this regard shall be provided.

At existing substations, the fire-fighting systems as available shall be extended to meet the additional requirements.

B.3.3 Oil evacuating, filtering, testing and filling apparatus

To monitor the quality of oil for satisfactory performance of Transformers, Shunt Reactors and for periodical maintenance necessary oil evacuating, filtering, testing and filling apparatus would be provided at new substations. Oil storage tanks of adequate capacities for storage of transformer oil would be provided.

Online Transformer Oil Drying Out System shall be provided in line with the provisions of Standard Specification and Technical Parameters for Transformers and Reactors (66 kV and above Voltage Class) as amended up to date available on CEA website.

B.3.4 Illumination

Normal and emergency AC and DC illumination shall be provided adequately in the control room and other buildings of the substation. The switchyard shall also be provided with adequate illumination.

The lighting of the entire control room building, fire-fighting pump house, other building (if any) and switchyard shall be done by LED based low power consumption luminaries.

B.3.5 Control Room

For the new substation, substation control room shall be provided to house substation work stations for station level control (SAS) along with its peripheral and recording equipment, AC and DC distribution boards, DC batteries and associated battery chargers, Fire Protection panels, Telecommunication panels and other panels as per requirements. Air conditioning shall be provided in the building as functional requirements. Main cable trenches from the control room shall have adequate space provision for laying of cables from the control room for all the future bays.

At existing substations, the adequacy of size of control room shall be ascertained and the same shall be augmented as per requirement.

B.3.6 Control Concept

All the EHV circuit breakers in substation/switching stations shall be controlled and synchronized from the switchyard control room/remote control center. All the isolators shall have control from remote/local whereas the earth switches shall have local control only.

B.3.7 Visual monitoring system (VMS) for watch and ward of substation premises:

Visual monitoring system for effective watch and ward of substation premises shall cover all the transformers and reactors, all other major AIS Equipment (such as CB, isolators, CT, CVT, SA etc. as applicable), GIS bays, panel room, all the gates of switchyard and all entry and exit points of control room building and accordingly the location of cameras shall be decided. In addition to the gates of the switchyard, the cameras shall also be located around the boundaries at suitable locations. The camera shall be high definition color CCD camera with night vision feature. The VMS data partly/completely shall be recorded (minimum for 15 days) at least @25fps (or better) and stored on network video recorder. The system shall use video signals from various cameras installed at different locations, process them for viewing on workstations/monitors in the control room and simultaneously record all the cameras. The VMS data should go only to the intended personnel/facility and not to the remote server of the Camera (VMS supplier).

Mouse/keyboard controllers shall be used for pan, tilt, zoom and other functions of the desired camera. The Visual Monitoring System shall have provision of WAN connectivity for remote monitoring.

All camera recordings shall have Camera ID and location/area of recording as well as date/time stamp. The equipment should generally conform to Electromagnetic compatibility requirement for outdoor equipment in EHV substation.

At existing substations, the visual monitoring system if available shall be augmented as per existing or better specification as required.

B.4.0 General Facilities

- a) Line Gantry/ Towers are envisaged for bays under the present scope only. However, for the adjacent future line bay, tower shall be designed for extension (considering Quad conductors for 765 kV and 400 kV future lines) wherever applicable.
- b) Bay extension works at existing substation shall be executed by TSP in accordance with the requirements/provisions mentioned above. However, interface points shall be considered keeping in view the existing design/arrangement at the substation.
- c) TSP has to arrange for construction power and water on its own.
- d) All outdoor steel structures including anchor/foundation bolts shall be fully galvanized. The weight of the zinc coating shall be at least 610 gm/m² and 900 gm/m² for coastal/ creek regions (if applicable).
- e) In 765 kV and 400 kV switchyard, if spare bay of half diameter is identified as future, all the equipment for Tie and Future Bay shall be designed considering the current rating of line bay i.e. 3150 A.
- f) Boundary wall shall be brick masonry wall with RCC frame or Stone masonry wall or Precast RCC wall under present scope along the property line of the complete substation area including future switchyard area to prevent encroachment and unauthorized access. Minimum height of the boundary wall shall be of 1.8 m from finished ground level (FGL).
- g) All electrical equipment shall be installed above the Highest Flood Level (HFL) and where such equipment is not possible to be installed above HFL, it shall be ensured that there is no seepage or leakage or logging of water.

- h) As per CEA (Technical Standards for Construction of Electrical Plants and Electric Lines) Regulations, 2022 and CEA Manual on Transmissions Planning criteria, 2023, Line approaching substation shall normally be perpendicular to the substation boundary for a stretch of 2-3 kms. Accordingly, TSP shall ensure that line terminations at substations are arranged in a manner to avoid hindrance to future line terminations at the substations.

B.5 EXTENSION OF EXISTING SUBSTATION

The following drawings/details of the existing substation are attached with the RFP documents for further engineering by the bidder.

Sl. No.	Drawing Title	Drawing No./Details	Rev. No.
A.	400 kV Sonipat S/s		
1.0	Single Line Diagram	C/ENGG-SS/NR-I/JIND/ SONEPAT/EXT/SLD/01	00
2.0	General Arrangement	C/ENGG-SS/NR-I/JIND/ SONEPAT/EXT/GA/01	--`
3.0	Earthmat Layout	SIPS-PGCIL-SNP-400-SYD-LAY- 003	01
4.0	Visual Monitoring System	Make: Qognify Model: Nice Vision Control	--
5.0	Bus Bar Protection	Make: ALSTOM Model: P741	--
6.0	Substation Automation System (SAS)	Make: Alstom Model: DS agile aview	--`
B.	400 kV Jind S/s		
1.0	Single Line Diagram	C/ENGG-SS/NR-I/JIND/EXT/ SLD/01	00
2.0	General Arrangement	C/ENGG-SS/NR-I/JIND/EXT/	00

Transmission Service Agreement

		GA/01	
3.0	Earthmat Layout	5427PS088-JND-E-SYD-0005-GA	R0
4.0	Visual Monitoring System	Nice vision software/PTZ Dome Camera	--
5.0	Bus Bar Protection	Make: Schneider electric Model: MICOM P741	--
6.0	Substation Automation System (SAS)	Make: GE Model: DS Agile	--

Bidder is advised to visit the substation sites and acquaint themselves with the topography, infrastructure such as requirement of roads, cable trench, drainage, space availability in control rooms and LT panel room etc. and also the design philosophy.

SPECIFIC TECHNICAL REQUIREMENTS FOR STATCOM

The proposed STATCOMs shall be generally conforming to the requirements of CEA (Technical Standards for Connectivity to Grid) Regulations, 2007 including amendments and CEA (Technical Standards for Construction of Electrical Plants and Electric Lines) Regulations, 2022, as amended from time to time. Other CEA Regulations and MoP guidelines, as applicable, shall also be followed and complied with.

C.1 Introduction:

This technical specification for a STATCOM Station consists of STATCOM, Mechanically Switched Capacitors (MSCs) and Mechanically Switched Reactors (MSRs) (to be installed at MV bus) including associated coupling Transformer (rated 400/ xx kV) and other equipment connected to the 400 kV bus. MV voltage level (xx kV) of the coupling Transformer can be chosen by the TSP to optimize the offered solution which meets functional requirement of this Technical Specification.

The STATCOM station shall operate asymmetrically in the leading and lagging MVAR regions as applicable to reach the dynamic range specified. The purpose of the STATCOM station is to regulate the voltage of 400 kV Bus Point of Common Coupling (PCC). The Configuration and the nominal rating of the STATCOM station is specified in this document.

The main building block of the STATCOM should be single phase Voltage Source Converter (VSC) based convertor valve (multi-level) operating in a way to eliminate or minimize AC filter requirement to High pass filter only and connected to the xx kV bus through air core reactors.

C.1.1 Definitions and Abbreviations

For the purpose of this specification, the following definitions / abbreviations are used:

PCC: Point of Common Coupling (herein also called as Point of Interconnection (POI)). The connection point between the STATCOM and the ISTS at which performance requirements are defined.

Reference Voltage (Vref): The Point on the voltage/current (V/I) characteristics where the static synchronous compensator (STATCOM) is at zero output (i.e. where no reactive power is absorbed from, or supplied to, the transmission system where the voltage is controlled)

MV: Medium Voltage.

STATCOM Unit: Static Synchronous Compensator based on Multi-Module technology and including air cored reactors as needed, Valve cooling, switchgear and its control and protection.

STATCOM: Static Synchronous Compensator consisting of STATCOM Unit(s) connected to a common coupling Transformer. A static synchronous generator operated as a shunt connected compensator, whose capacitive or inductive output current can be controlled independently of the AC system voltage.

MSC: Mechanically Switched Capacitor (Including Switchgear). A shunt-connected circuit containing a mechanical power-switching device in series with a capacitor bank and a current limiting reactor.

MSR: Mechanically Switched Reactor (Including Switchgear). A shunt-connected circuit containing a mechanical power-switching device in series with a reactor.

Sub Module: Basic single power module of a Multi Module STATCOM unit Valve. It is a Part of a STATCOM unit valve comprising controllable switches and diodes connected in full bridge arrangement, together with their immediate auxiliaries, and storage capacitor, if any, where each controllable switch consists of one or more switched valve device(s) connected in series.

Valve: Electrically and mechanically combined assembly comprising of forced commutated devices [for example insulated-gate bipolar transistor (IGBT)] assembled in levels, complete with all connections, auxiliary components, and mechanical structures, which can be connected in series with each phase of the reactor of a STATCOM unit.

Valve Section: Electrical assembly defined for test purposes, comprising one of several sub-modules.

Valve Structure: Physical structure holding valve(s), which is insulated to the full system voltage above earth potential.

STATCOM Station: STATCOM Station includes 400 kV Switchgear, Coupling Transformer, STATCOM, MSCs (as applicable), MSRs (as applicable) along with its switchgear and complete integrated control and protection whose outputs are coordinated. (Complete turnkey delivery at site).

CT: Current Transformer.

VT: Voltage Transformer.

SAS: Substation Automation System.

Response Time: The duration from a step change in control signal until the voltage changes by 90% of its final change, before any overshoot.

Settling Time: The duration from a step change in control signal input until the STATCOM output settles to within $\pm 5\%$ of the required control output.

Slope: The ratio of the voltage change to the current change over a defined controlled range of the STATCOM, normally the full (inductive plus capacitive) range at nominal voltage, expressed as a percentage.

VSC: Voltage Source Converter, a forced commutated device (for example, IGBT) based self-commutated converter that is capable of generating AC voltage from DC capacitor.

Voltage/Current (V/I) Characteristic: The relationship between the current of the STATCOM and the voltage at the point of connection.

Lagging Operation: Inductive operation or reactive power absorption of the STATCOM similar to a shunt reactor.

Leading Operation: Capacitive operation or reactive power generation of the STATCOM similar to a shunt Capacitor.

TSP: Transmission Service Provider

C.2 Relevant Standard:

STATCOM Station shall comply with the following standards (latest edition):

Sl. No.	Description	Standards
1	Voltage Source Converter (VSC) valves for STATCOM	IEC- 62927 IEEE- 1052 IEC-60747
2	Control, protection and monitoring	IEC-61000 IEC-60255
3	Valve Hall for housing the equipment as above comprising of: - wall bushings for connection between converter phases and decoupling reactors, - piping and tubing connections of the cooling system to converter - connection of the control cabinet with the converter through optical fibers	IEC-60071 IEC-60270 IEC-60137

Sl. No.	Description	Standards
	- internal lighting, auxiliary power supply (AC and DC) and power socket system - internal HVAC system	
4	X kV, dry insulated, air core and air self-cooled decoupling reactors. Mechanically Switched Reactors, half-reactors stacked on above the other, Outdoor installation, Complete with supporting structures	IEC- 60076
5	Power Capacitors (MSC, etc.)	IEC-60871-1
6	400 kV Power transformer (Coupling Transformer)	IEC-60076 IEC-60354
7	CT's and VT's	IEC- 61869
8	Dis-connectors and Earthing Switches	IEC- 62271
9	HV and MV Circuit Breakers	IEC- 62271
10	Surge Arresters	IEC- 60099
11	Auxiliary and grounding transformer	IEC- 60076 IEEE C57.32 IS- 5553 (Part 6)
12	Neutral Grounding Resistor, charging resistor	IEEE- C57.32
13	UPS, SMPS and Other Power supply units	IEC- 62040 IEC- 61558
14	Cyber Security	IEC-62243

C.3 Scope of work for STATCOM

The scope of work with regard to the works associated with the STATCOM shall comprise ± 300 MVAR Modular Multi-level Voltage Source Converter (MMC-VSC) based STATCOM along with 2x125 MVAR MSC (Mechanically Switched Capacitors) and 1x125 MVAR MSR (Mechanically Switched Reactors).

STATCOM can either be Single/ multiple units. The minimum size of a unit allowed is 150 – 200 MVar. TSP shall ensure that there are no coordination issues between multiple STATCOM branches of STATCOM station. Further complete Dynamic range for STATCOM may also be installed based on appropriate studies instead of combination of VSC with MSC/MSR technology. Minimum MV bus voltage is to be decided by OEMs.

The TSP shall be responsible for the complete installation of STATCOM station along with the substation works as specified in the complete scope of work.

The TSP shall also perform the system studies (steady state and dynamic) according to the requirement mentioned and documentation of the same shall be preserved by TSP and to be submitted to CEA/CTU/GRID-INDIA, as per their request.

TSP shall carry out a detailed study on prevailing system conditions before interconnection of the STATCOM to assess the performance of the STATCOM. Parameters tuning to avoid any adverse impact on the grid with integration of the STATCOM shall also be identified and implemented at this stage. TSP shall carry out tuning of Power Oscillation damping (POD) along with an interaction study with nearby HVDC/FACTS controllers. In line with previously executed projects in India, the tuned network file ‘no initial conditions suspects’ and a converged file shall be provided by CTU to TSP. These files shall be made available within 60 days from award of the contract.

TSP shall ensure interconnection study at the time of commissioning and shall also be responsible for tuning the POD during the license period as per relevant standards (e.g. IEEE 1052).

The switchgear for connection of STATCOM units, MSCs and MSRs provided on the secondary side of the coupling transformer shall be of standard voltage rating as per relevant IEC. The switchgear, structure, control, protection and substation automation on the 400 kV side shall be as per applicable Technical Specification of the substation equipment.

Generally, the purpose of STATCOM is to improve system stability, provide damping, and smooth out the step voltage change associated with MSCs, MSRs and external compensating equipment (i.e. any existing capacitor and reactor banks) switching and provide steady state VARs as needed to support the 400 kV bus voltage.

In order to get optimum control of MVAR, the control of MSCs and MSRs, as well as reactor banks connected on the 400 kV HV side, may be integrated along with STATCOM control to provide steady state 400 kV bus voltage control in a smooth

manner. MSRs and MSCs are to be switched to relieve the STATCOM from high level operation, reduce its continuous losses and maximize its dynamic control potential. There should be a provision for the independent operation of MSC/ MSR after delinking it with STATCOM controls when STATCOM is out of service due to any reason. Switching of MSC/ MSR shall be based on value of external bus voltage.

The operating functions of the STATCOM Station shall include:

- Steady state voltage control of 400 kV bus,
- Balance steady state voltage at 400 kV bus,
- Dynamic over-voltage control,
- Transient and Dynamic stability control
- Damping of Power Oscillations

It is assumed that the arresters will limit any transient and switching surge over voltages and may also, by design, limit dynamic over voltages.

The requirement of reactive power compensation (as defined above) guaranteed by the TSP shall not be less than the levels specified considering following.

- The total cumulative Capacitive (+) and Inductive (-) MVAR rated Capacity of STATCOM Station as defined above comprising of STATCOM, MSCs (as applicable), MSRs (as applicable) coupling transformer, coupling reactor or any filter (if applicable) shall be rated at 1 p.u. voltage, 1 p.u. frequency and 50 °C (Celsius) ambient temperature at 400 kV Bus (Referred to as “Point of Common Coupling” or PCC).
- Capacity of one or more branches of MSC, MSR in STATCOM Station can be included in the STATCOM with equivalent capacity. Accordingly, ratings of STATCOM Unit/Branch equipment may be designed.

Example of equivalent acceptable solutions for each STATCOM Station is given below:

For ±300 MVAR STATCOM:

Option 1: ±300 MVAR STATCOM, 2x125 MVAR Mechanically switched Shunt Capacitor (MSC), 1x125 MVAR Mechanically switched Shunt Reactor (MSR).

Option 2: +425/-300 MVAR STATCOM, 1x125 MVAR Mechanically switched Shunt Capacitor (MSC), 1x125 MVAR Mechanically switched Shunt Reactor (MSR).

Option 3: +300/-425 MVar STATCOM, 2x125MVar Mechanically switched Shunt Capacitor (MSC).

Option 4: ±425 MVar STATCOM, 1x125 MVar Mechanically switched Shunt Capacitor (MSC)

Option 5: +550/-425 MVar STATCOM

- The rated capability of STATCOM, MSC (as applicable) and MSR (as applicable) shall be at 400 kV (Referred to as “Point of Common Coupling” or PCC) and in the steady state frequency range of 48.5 Hz-50.5 Hz.
- The STATCOM Station including STATCOM Units, MSCs and MSRs shall be designed to operate continuously under the worst possible combination of steady state voltage range of 360-440 kV and frequency range of 47.5 Hz – 52.5 Hz respectively and transient and temporary over voltages defined in Clause C.6.1-f).
- The AC voltage unbalance at fundamental frequency shall be assumed equivalent to a negative phase sequence component of 1.5% for equipment rating purposes.
- The reactive power compensation levels shall be determined by manufacturing tolerances of the components and measurements carried out using metering accuracy instrumentation at the 400 kV feed points to the STATCOM Station.
- The reactive power capability shall also be determined by calculations based on test values of appropriate quantities at the discretion of the owner.
- In calculations of capability and availability, the owner shall assume the most unfavourable combinations of control, manufacturing and measurement tolerances.
- In case more than one STATCOM Station are installed in a particular substation, each STATCOM Station shall be connected to 400 kV bus individually with complete separate downstream system. Each individual STATCOM station shall have complete independent yet coordinated control system to avoid simultaneous tripping of both STATCOM Stations. The system shall be design in such a way that single common contingency (other than loss of 400 kV voltage, abnormal system events) will not cause tripping of both STATCOM Stations.
- Operation of STATCOM Station shall not excite any resonance condition in connected Power System.

- Control of STATCOM Station shall be designed to prevent hunting between MSRs, MSCs and STATCOM.

C.3.1 STATCOM building

The STATCOM station shall have an independent building including a separate control room different from the main control room building of the 765/400 kV Substation.

The STATCOM Building shall comprise of following facilities:

1. Control and Relay Panel room
2. ACDB and DCDB room
3. Battery room
4. Service Room cum workshop
5. Conference room
6. Valve hall
7. Cooling system room
8. Lobby
9. Corridor with minimum width of 1600 mm
10. Portico
11. Common Toilet
12. Provision of shaft for electrical, sanitary, water supply facilities
13. Other facilities as per functional requirement of building
14. AHU Room

C.4 Ambient Condition

STATCOM Station should be designed to perform at 50 °C ambient temperature.

C.5 Power System Characteristic

The following AC power system characteristics apply at the point of connection i.e. point of common coupling in this case (PCC). STATCOM station operation is required within the parameter value and duration given in following table:

S. No	Power System Characteristic	Value	unit
1.	Nominal ac system voltage, line-to-line	400	kV
2.	Maximum continuous ac system voltage, line-to-line	420	kV
3.	Minimum continuous ac system voltage, line-to-line	380	kV
4.	Maximum short-term ac system voltage,	448	kV

Transmission Service Agreement

S. No	Power System Characteristic	Value	unit
	line-to-line		
5.	Maximum duration of item 4	10	s
6	Continuous negative-sequence voltage component (used for performance calculation)	1	%
7	Continuous negative-sequence voltage component (used for rating calculation)	1.5	%
8.	Continuous zero-sequence voltage component	1	%
9.	Nominal ac system frequency	50	Hz
10.	Maximum continuous ac system frequency (for rated output)	50.5	Hz
11.	Minimum continuous ac system frequency (for rated output)	48.5	Hz
12.	Maximum short-term ac system frequency	52.5	Hz
13.	Minimum short-term ac system frequency	47.5	Hz
14.	Basic Insulation Level (BIL)	1550	kV peak
15.	Switching Impulse Level (SIL)	1050	kV peak
16.	Power Frequency Withstand voltage	630	kV
17.	Maximum three-phase fault current a) for performance requirements b) for rating of STATCOM X/R (Positive/Negative Seq)* X/R (Zero Seq)* Clearing time - normal Clearing time – backup	a) _____ b) _____ _____ _____ _____ _____	kA kA for 1s s s
18.	Maximum three-phase fault current	_____	kA
19.	Minimum three-phase fault current # -for performance requirements -for safe operation	_____ _____ _____	kA kA
20.	Maximum single-phase fault current	_____	kA
21.	Minimum single-phase fault current#	_____	kA

S. No	Power System Characteristic	Value	unit
22.	Harmonic impedance sectors for each harmonic number up to the 49 th harmonic or system impedance data as R-X values with frequency steps not larger than 1 Hz (for performance and/or STATCOM system component rating)	Chapter 7.3 of CIGRE Publication 139	
23.	Background harmonic voltage (or current) spectrum (for STATCOM components rating) (Distortion up to 15th Harmonic	5th Harmonic 1.5% 7th Harmonic 1.0% Other Harmonics 0.5% (each)	
24.	Power System Phase Rotation	CCW	

Note: Parameter Values for S.No. 19 to 23 shall be provided at later stage along with Network file (PSS/E)

For STATCOMs near RE complex:

The STATCOMs shall remain connected to the grid and shall be able to operate at rated reactive power capability when voltage at the interconnection point, on any single phase or all three phases dips up to the level depicted by the thick lines in the following curve (for specified time) and up to at least 0.3 pu in case of two phase faults:

V_T : Actual Voltage; V_n : Nominal Voltage

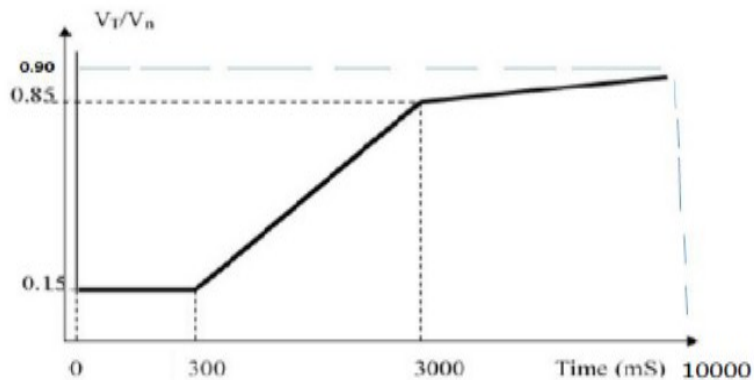

C.6 STATCOM Station Characteristics

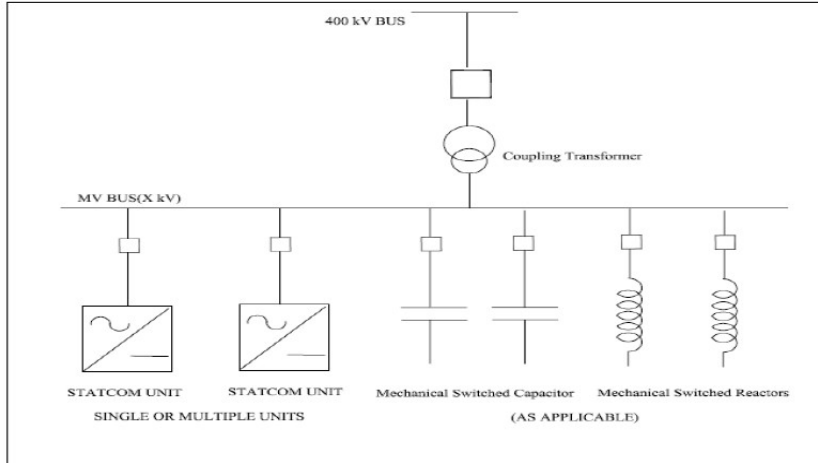

Figure-1: Conceptual Indicative Schematic diagram of STATCOM Station

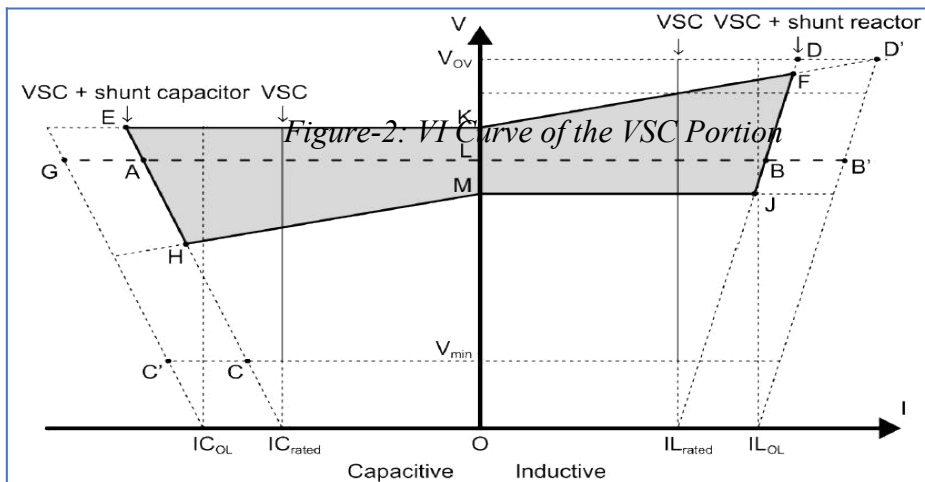
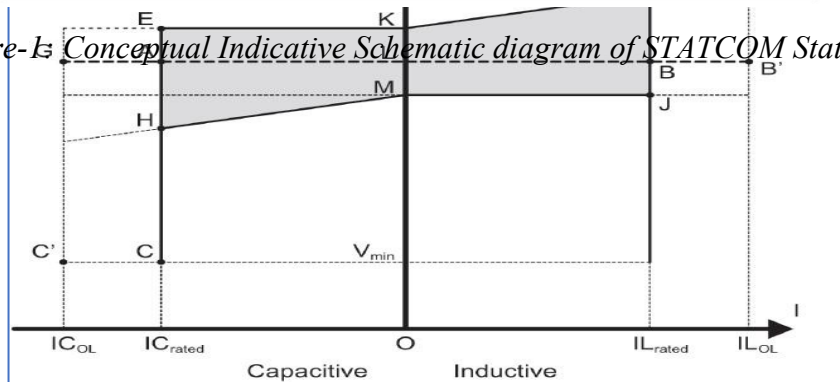

Figure-2: VI Curve of the VSC Portion

Figure-3: VI Curve of the STATCOM Station

C.6.1 STATCOM Station Ratings

The output of a STATCOM Station shall be adjusted continuously over the range illustrated in Figure-3.

The following items define the ratings of the STATCOM station equipment.

- a) The STATCOM Station should regulate the 400 kV bus voltage to a reference voltage of 400 kV (1.0 per unit, Point L Figure-3), continuously adjustable between 0.95 per unit and 1.05 per unit.
- b) The nominal capacitive and inductive reactive power output of the STATCOM should be as defined in the scope, at 1.0 pu ac bus voltage and nominal system frequency f, and 50°C ambient temperature (Point A and point B of figure-2).
- c) The slope of the STATCOM Station characteristic should be adjustable in steps of not greater than 0.5% between 1% and 8%, on a basis of cumulative MVA capacity of STATCOM Station (A+B in Figure-3).
- d) The STATCOM Stations near RE Complex shall continue to inject reactive power during temporary under voltage down to 60 kV (0.15 pu) for the duration 0.3 sec (Point C) and STATCOM behavior for voltages above 0.15 pu shall be as specified under section C.5 above; the STATCOM system may be tripped (or blocked) if the under voltage persists for time beyond limits specified under section C.5 above.

The STATCOM Stations (other than RE Complex) shall continue to inject reactive power during temporary under voltage down to 120 kV (0.3pu) (Point-C) for the duration 5sec; the STATCOM system may be tripped (or blocked) if the under voltage persists for time beyond limits specified under section C.5 above.

- e) The STATCOM shall continue to absorb reactive power during HVRT Conditions in a controlled manner as per the following.

Nominal Voltage (pu)	Minimum time for remaining connected to the Grid
-----------------------------	---

$V > 1.50$	Instantaneous trip
$1.50 \geq V > 1.30$	100 milli seconds
$1.30 \geq V > 1.10$	10 seconds
$V \leq 1.10$	Continuous

STATCOM Station may be tripped if the respective temporary over voltages as mentioned above persists for more than its respective mentioned duration.

- f) The STATCOM Station should be capable of repeating temporary operation as defined in any one of item (d) and (e) as above for at least 3 charging cycles in 60 mins.
- g) The coupling transformer and all bus equipment, such as filter branches (if applicable), MSC and MSR branches etc. and the MV Bus should be rated to withstand the specified continuous and short-term operation, and to withstand or be protected against voltage and current stresses that exceed these conditions.
- h) All equipment in the STATCOM Station should be capable of sustaining, without damage, any fault limited by the maximum design short circuit level of the system and the Coupling transformer impedance.
- i) The TSP shall assume the negative sequence voltage of 1% at rated short circuit level and provide control to reduce this unbalance.
- j) The injected harmonic current distortion by STATCOM Station under the full operating range measured at 400 kV Bus (PCC) in accordance with IEEE – 2800 Standard.
- k) The STATCOM controls should be designed to correct negative sequence voltage during steady state operation.
- l) The switching module design should include an appropriate allowance for stray capacitance and component tolerances.
- m) The STATCOM should be designed to prevent, or alternatively to withstand, false firing events, i.e., the firing of any valve at an incorrect time in the cycle or when not ordered.

C.6.2 Control Objectives

The control system shall control the STATCOM, MSCs, MSRs required under this specification, as well as all bus reactors on the 400 kV HV bus of the substation.

Operation logic for the breakers, disconnectors and earth-switches in the STATCOM Station shall also be incorporated in the control system. The control shall be programmable and shall have sufficient scope and flexibility (software programming margin of at least 20%) to permit re-programming according to future changes/ addition in the power system. The operator interface must be integrated in a latest version of Windows environment.

C.6.2.1 STATCOM Station Functions and Applications

C.6.2.1.1 Voltage Control mode (Automatic and Manual)

The control of the positive sequence component of the fundamental frequency voltage in steady state at POI, with slope in the range as specified at clause 6.1 c) above.

There shall be following provisions in STATCOM System to operate in Voltage Control Mode:

- a) To adjust the reference voltage for changes by Grid operator.
- b) To adjust the value of reactive power droop in pu to provide a stable, coordinated and dynamic response.
- c) To adjust the voltage dead band with a minimum magnitude of ± 0.05 pu

C.6.2.1.2 Fixed Reactive Power Mode

In this mode, the STATCOM system shall maintain a specified constant reactive power output at the POI under continuous/ steady state operating region. The target reactive power level and mode (injection or absorption) shall be specified by the Grid Operator. There shall be a provision to adjust the reactive power set point. The dynamic response of the STATCOM system to any changes in reactive power shall be positively damped with a damping ratio of 0.3 or better.

C.6.2.1.3 Steady State Condition

The STATCOM Station (STATCOM along with MSCs and MSRs) shall provide necessary reactive power support to the 400 kV bus (PCC) to compensate for voltage variation under steady state.

C.6.2.1.4 Dynamic Over-voltage Control Performance

The STATCOM shall be required to provide necessary reactive power support with fast and smooth variation so that over-voltages under dynamic conditions are controlled. STATCOM shall smooth out the step caused by the switching of MSCs and MSRs.

The operation of each STATCOM over its range of MVAR from full capacitive to full Inductive capacity and vice-versa shall be on the basis of smooth variation.

C.6.2.1.5 Transient and Dynamic Stability Performances

The STATCOM Station shall provide necessary reactive power so that the transient and dynamic stability of the Owner's system is enhanced.

C.6.2.1.6 Damping of Power Oscillations

The STATCOM shall provide necessary damping to power oscillations by modulating its output in its entire range based on the measured rate of change of power/frequency at the 400 kV bus. The damping controller would track local area oscillations as well as wide area oscillations and control would include several loops each focused on different frequencies.

TSP shall ensure the damping of oscillation during the entire license period including the pre-commissioning period as per relevant standards. (e.g. IEEE 1052).

C.6.2.1.7 Facility for compensation of phase imbalance

Provide negative phase sequence voltage control to minimize the presence of negative sequence content of the 400 kV bus voltage.

C.6.2.1.8 Start up and Initial Switching

The operation of STATCOM Station during start-up/initial switching on should not create significant energizing transients causing voltage drop, voltage distortion and swinging of transmission voltage angle at the PCC bus by more than +/-5%. TSP shall have to ensure this analytically during the design phase and also in the field after the commissioning of the facility. TSP shall prepare the design documentation and the same shall be preserved by TSP and to be submitted to CEA/ CTU/ GRID-INDIA, as per their requirement.

C.6.2.1.9 Gain Supervision and Control

To control the regulator gain in order to prevent oscillations and excessive overshoot in the STATCOM response, a gain supervision function shall be implemented. This shall be an essential function for the supervision of stability of closed-loop voltage control. The function of this controller is that when the supervision of the gain in the voltage regulator detects oscillations in the voltage controller output, the gain shall gradually be reduced until stability is reached. Normally it is a changed condition in the transmission system contribution to the closed loop gain that results in instability. The reduction in the voltage regulator gain shall only balance the external change. The control should be adaptive in order to maximize its effectiveness. The gain reductions should be indicated and the reduction of the gain shall be able to be reset to nominal value by means of commands from the operator interface or automatically. A relative gain factor shall also be able to be changed from a gain optimizer.

C.6.2.1.10 Coordinated reactive power control of external devices

To optimize the use of dynamic VARs versus steady state VARs, control of externally connected shunt capacitor or reactor banks shall be implemented. Such banks will be connected locally to a HV bus or/ and at MV bus. For simultaneous control with the supplementary VSC current controller, coordination for the two functions shall be provided. External devices like Mechanically Switched Capacitors (MSC)/ Mechanically Switched Reactors (MSR) can be switched ON or OFF to position the steady state operating point of the VSC so as to extend its dynamic range. There should be a provision for independent operation of MSC/ MSR after delinking it with STATCOM controls when STATCOM is out of service due to any reason. The threshold values for switching the MSC/MSR on/off shall be configurable in all modes of operation.

C.6.2.1.11 Supplementary VSC current controller

To optimize the use of dynamic VARs versus steady state VARs, a control function that slowly reduces or offsets the STATCOM point of operation shall be implemented. By deliberately adjusting the voltage reference setting within a narrow window the STATCOM system output is pushed towards either a specific point or towards a window to preserve dynamic range. This slow operating function is meant to provide for slower controllers, such as externally connected shunt banks to operate and meet the slower long term voltage variations caused by daily or weekly load variations. Rapid changes in the system voltage that call for dynamic compensation will have priority over this type of controller.

C.6.2.1.12 Gain optimization

To provide operation at optimal regulator gain, a fully automatic optimizing function shall be implemented. This function operates by inducing a small change in the STATCOM output. The gain is adjusted based on the network response signal.

C.6.2.1.13 Control of Direct Current

During STATCOM operations, any flow of direct current to the transformer's MV side must be less than 25% of the transformer magnetizing current. DC current flow in the transformer should be minimized by an independent control function that minimizes DC current. For presence of up to 0.2% second harmonic in 400 kV system, the STATCOM control should minimize DC current flow in the transformer.

C.6.2.2 Under Voltage Strategy

It is essential that the STATCOM Station operates in a robust manner when transmission system under voltages appears. For transmission system voltages down to 0.15 p.u for single phase or three phase fault and 0.3 p.u. for two phase faults., the STATCOM units

must operate unrestricted, producing its rated capacitive current. The STATCOM must be designed to operate at transmission system under voltage, even considering that severe voltage unbalances can appear. The STATCOM must not be restricted by short term negative sequence voltages up to 1.5%, appearing in conjunction with under voltages.

Transmission system under voltages below 0.15 p.u. will appear in conjunction with transmission system faults. The STATCOM must ride through during faults and post fault under voltages. The minimum trip delay for the STATCOM Station, upon complete loss of the transmission system voltage shall not be less than 5 seconds. If station AC auxiliary power distribution is affected, critical loads must be fed from DC station batteries, Uninterrupted Power Supply (UPS) without tripping the STATCOM Station. Adequate capacity must be kept in DC station batteries, UPS to feed critical loads for the smooth operation of the STATCOM Station facility. There must be redundant station battery system with each station battery system capable of delivering 100% load.

At under voltage conditions for the transmission system voltage, special control strategies are activated which override the normal control modes presented above. Normally if the voltage is low, the output from the STATCOM will be capacitive. If the voltage in all three phases goes below a level, but not greater than 0.15 p.u., a special under voltage strategy may be activated that controls the STATCOM output to 0 MVar. As soon as the voltage goes higher than 0.15 p.u., the under voltage strategy is deactivated and the normal control will be in operation (for the specified duration).

The STATCOM Station must not be tripped or shut down automatically due to under voltages appearing for specified duration as specified under section C.5 above. STATCOM Station must continue to operate when AC system Voltage on any or all phases dips down to 0.15 p.u. voltage as per the characteristic given at section C.5.

C.6.2.3 Over Voltage Strategy

C.6.2.3.1 The TSP shall carry out dynamic stability study upfront in order to assess the dynamic overvoltage requirements. These studies shall include conditions with maximum and minimum short circuit system MVA conditions, single phase and three phase faults as well as stuck breaker, outage of the nearby generator and also with the outage of parts of the STATCOM Station. It is important that the STATCOM Station rides through temporary over voltages and not trip when it is needed the most.

C.6.2.3.2 The system should be able to withstand any 3 phase, 5 cycle (100 ms) and single phase 10 cycles (200 ms) fault with consequent loss of a 400 kV double circuit line and loss of a 500 MW generator. The fault duration mentioned above corresponds to time assumed for the persistence of fault. For other system parameters refer clause 5 above (Power System

Characteristics). In addition to above requirement, system contingency cases as provided in Annexure-I need to be considered and satisfied.

C.6.2.3.3 The 400 kV system and equipment to which the STATCOM Station is connected is designed to withstand switching surge overvoltage up to 2.5 p u and power frequency over voltages up to 1.5 p u with initial value of the temporary overvoltage up to 2.0 p u for 1-2 cycles. Based on arrester coordination and under the worst case scenario the 400 kV system phase to ground peak over voltages may be expected as follows

- i) 650 kVp for 03 peaks
 - ii) 575 kVp up to 5 cycles
 - iii) 530 kVp up to 1 second
 - iv) 475 kVp up to 10 seconds
- a) The STATCOM Station shall be designed to withstand these sequential over voltages.
 - b) If the over voltages greater than 1.1 pu are exceeded in magnitude and duration due to any system contingencies, suitable control action shall be taken by STATCOM Station to bear this kind of contingency.
 - c) The TSP shall evolve the insulation co-ordination of the components of the STATCOM Station after studies have been conducted to determine the over- voltage profile with the STATCOM connected to the system.
 - d) The TSP shall ensure that STATCOM Station will not excite ferro-resonance and sub-synchronous oscillation in the AC system. The study report in this regard shall be preserved and to be submitted to CEA/ CTU/ GRID-INDIA, if required.
 - e) It may also be noted that the tripping action for 400 kV lines is initiated if the overvoltage exceeds 1.1 p.u. for 10 seconds. The tripping of 400 kV lines is initiated if 1.3 p.u. voltage persists for more than 100 milli seconds. The over voltage strategy shall be coordinated with these settings such that the STATCOM Station rides through up to these levels.

C.6.2.4 STATCOM Station Over load/ Over Current

The overvoltage cycles mentioned in clause 6.2.3.3 above create a corresponding current overload in the STATCOM Station components; the STATCOM Station and its components shall be designed to withstand these.

In addition to the above the STATCOM Station and its components shall be designed to withstand overloading caused due to the following eventualities.

- i) Short circuits and ground faults in the 400 kV system especially those occurring near the STATCOM Station and medium voltage bus of the STATCOM Station.

- ii) Transient overvoltage due to switching operations and atmospheric effects.
- iii) Temporary over voltages.
- iv) Short circuits in the transformer secondary circuit such as:
 - Bushing terminal fault
 - Flashover across a reactor, Bus Bar and other connected components/switchgear etc.
- v) Protection system faults.

If the rated overvoltage is exceeded as a result of prolonged stressing or for other reasons, the protection specified elsewhere in the specification shall come into effect to prevent damage.

C.6.2.5 Dynamic Performance Controls of STATCOM Station

The TSP must describe in detail, the dynamic reactive power controls for enhancing stability margin and also damp oscillations of any critical frequencies. The dead band for continuous damping control must be very small so that there are no discernible sustained oscillations.

C.6.2.6 Protective Control Functions

TSP shall provide all necessary protections including Main and Back-up protections for all protective zones and equipment like transformers, STATCOM Units, MSCs (if applicable), MSRs (if applicable), MV Bus Bar etc. TSP shall provide any protective control functions to meet the performance requirement of STATCOM under the scope of the TSP.

a) Overvoltage Protection

TSP shall provide adequate overvoltage protection as a result of any normal operation, mal-operation or system event.

b) Over current Protection

TSP shall provide adequate over-current protection for the STATCOM Station as a result of any abnormal operation, mal-operation or system event.

c) Gate level control Supervision

TSP shall provide adequate Sub module Gate level control supervision.

C.6.2.7 STATCOM Station Response

STATCOM station response shall be such that the change in measured system voltage to small disturbance should reach 90% of the desired total change within 30 ms of initiating

a 5% step change of voltage reference. The maximum overshoot should not exceed 120% of the total change and the settling time should not exceed 100 ms, after which the voltage should be within $\pm 5\%$ of the final value. This response characteristic within these limits must be respected when the system's three-phase fault MVA is between the minimum and maximum value defined in clause-5. The response of the system voltage using the actual controller should be validated on a real time simulator during the factory acceptance test (FAT) at the manufacturer's premises. For the purpose of STATCOM Station, response time measurement and signal conversion of the voltage, the error should not exceed 0.3%. The voltage response acquisition circuit should have a response time of no longer than 10 ms. However, time longer than 10 ms can be allowed provided the requirement of STATCOM response time is met.

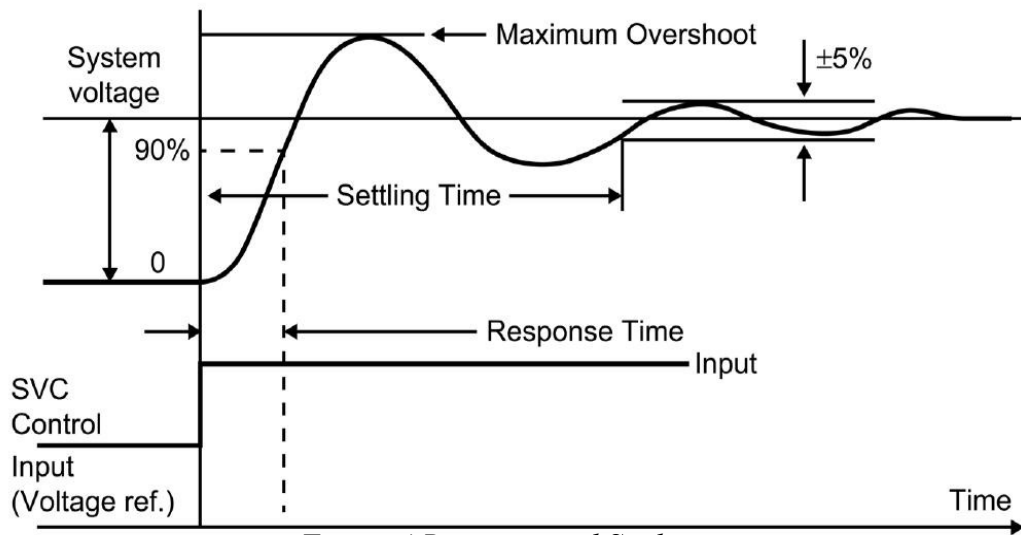

Figure-4 Response and Settling time

C.6.3 Harmonic performance and AC harmonic filter design

It is likely that with multi-level VSC based technology, no filters or only a small high-pass filter will be needed. The STATCOM shall be operable without AC filters. The STATCOM Station should be designed to eliminate the effects of any harmonic resonance between its MSRs, MSCs banks, filter branches, and the AC system. To limit the harmonic distortion imposed on the 400 kV transmission system, the additional contribution of harmonic distortion from the STATCOM Station to 400 kV system (PCC) should not exceed 1% for the total and 0.5% for any specific harmonic.

C.6.3.1 Filter performance

The distortion levels as specified should be met for the following:

- a) The continuous range of all system and environmental conditions.
- b) Variation in total filter capacitance due to manufacturing tolerance, ambient temperature, aging, and changes in capacitance up to alarm level.
- c) Variation in tolerance for STATCOM parameters, such as transformer winding unbalances, valve firing variations MSC and MSR unequal reactor and capacitor reactance between phases.
- d) System frequency in the range of 48.5 Hz to 50.5 Hz. Calculation should take into account all possible combinations of STATCOMs, MSCs and MSRs.

C.6.3.2 Filter component rating

The harmonic filter components (and other STATCOM components) should be rated to carry continuously the harmonic currents caused by the background harmonic distortion of the system and the harmonic currents produced by the STATCOM itself. Unless otherwise specified, harmonic currents from the system and the STATCOM of the same order should be added arithmetically. All filter harmonic currents of different order should be added quadratically (root sum of squares).

The rated voltage of capacitors should be derived from the largest arithmetic sum of the power-frequency and individual harmonic voltages obtained from stress calculations in continuous operating conditions (Note: Maximum fundamental voltage and maximum harmonic contributions may not exist at the same time for STATCOM configurations including MSRs or MSCs).

For filter capacitor voltage rating, the loss of capacitor unit or elements should be considered up to the trip level.

The rated voltage of so-called "low voltage" capacitors (e.g. in double or triple tuned filters) should be chosen such as to also withstand imposed transient stresses from faults, energization, or other switching events.

C.6.3.3 Harmonics at PCC

The STATCOM Station's contribution to the harmonic distortion levels at the STATCOM Station connection point (PCC) to the transmission system shall not exceed the limits defined in IEEE-2800 standard.

C.6.3.4 Harmonic calculation:

Chapter 7.3 of CIGRE Publication 139 together with information in PSSE network files given shall be used for the Network harmonic impedance.

C.6.4 MV Switchyard

- Medium Voltage (MV) delta bus shall be grounded through a Grounding Transformer (i.e. zig-zag winding Transformer) along with a suitable resistor in the neutral.
- MV Switchyard of different STATCOM Station branches shall be fenced with a fence height of 3 meter. To minimize the probability of electrical fault suitable arrangement i.e. electrified fence shall be done to prevent the encroachment of unwanted animals or other to minimize the probability of electrical faults (Ph-E, Ph-Ph). Further bus bar arrangements shall be made in a way to minimize the probability of electrical faults.
- Secondary side of the Coupling Transformer shall be provided with suitable surge capacitors to mitigate transfer surges.
- For MV bus bar, an Aluminum conductor (Tube, Rectangular Hollow Section or C Section) may be used, however, a suitable bus bar end cover/cap shall be provided to avoid any animal/bird entering the hollow space.

C.6.5 Broadband Interference

C.6.5.1 Radio Interference

The TSP shall take necessary precautions in the form of shielding of valve hall and building or Containers to meet its own requirement together with any requirements that may be specified in Section-Project. Further, the following requirements shall also be met:

- a) With the STATCOM Station operating at any load upto rated value and within the design range of firing angle, the radio interference level from electromagnetic or electrostatic inductions generated by the STATCOM station shall not exceed 100 micro-volts/m,500 m away from STATCOM fence or boundary of the substation whichever is higher. The Radio Interference Level (RIL) criteria shall be achieved at all frequencies within the range of 150 kHz to 300 MHz and with the STATCOM operation at any level up to and including rated value. The design shall provide correcting measures, in case the specified design not being realized in the final installation. In case of any third-party complaints about the radio interference, suitable measures shall be implemented by TSP..

- b) Measurements of actual RI at STATCOM Station shall be made by the TSP, at points along the above defined contour and at other critical points.
- c) RIV (Radio Interference voltage) measured at a phase to ground voltage (266 kV rms) in accordance to NEMA-107 shall not be more than 500 micro-volts for 400 kV system. For other system voltages, IEC/NEMA in the order of preference shall be applicable.

C.6.5.2 Interference with Power Line carrier and open wire carrier system

The TSP shall take the necessary precautions in the form of noise suppression techniques and filtering devices to prevent harmful interferences from STATCOM Station to the power line carrier communication (PLCC) system operating on connected AC transmission network.

The frequency spectra to be protected are:

System	Frequency spectrum
Power Line carrier	30 kHz to 500 kHz
Open wire carrier	5 kHz to 30 kHz

C.6.6 Audible Noise

The TSP shall limit the audible noise in various areas of the STATCOM Station buildings and containers to the following values.

Valve hall (Inside)	90 dBA
Mechanical equipment areas indoor (measured at 2 meter distance)	75 dBA
Mechanical equipment outdoor (Measured at 15 m distance)	75 dBA
Control Room Building*	60 dBA
At the limits of the STATCOM STATION perimeter fence	80 dBA

**This is the background noise from the ventilation system in adjacent rooms, control cubicles etc. Printers, recorders may be switched off during the measurement.*

C.6.7 Loss Requirements

- C.6.7.1** The TSP must guarantee the total losses of STATCOM Station, be less than 1% of the reactive power output individually at its inductive limit (STATCOM+MSRs) and capacitive limit (STATCOM+MSCs) for the cumulative highest reactive power output of STATCOM Station at PCC with the worse combination of manufacturing tolerances for the Option-1 to 4 as provided in clause C.3. In case of Option 5 as provided in clause A.3

i.e. +550/-425 MVAR STATCOM without MSC and MSR, the TSP must guarantee the total losses of STATCOM Station will be less than 1.5% of the reactive power output individually at its inductive limit and capacitive limit for the cumulative highest reactive power output of STATCOM Station at PCC with the worse combination of manufacturing tolerances. For the purpose of total loss measurements, it should be assumed that the ambient temperature is 20 °C, the PCC voltage is 1 per unit, and the slope setting is 1%. The STATCOM system may not operate under these conditions, but they provide a common base.

- C.6.7.2** The total losses shall include all components, as well as different parts or subsystems of the complete STATCOM Station such as coupling transformer, All VSC systems and components, MSC and MSR, Control and protection systems, including ancillary devices such as HMI, fault recorders, and SCADA, Auxiliary Power supply systems, cooling systems, Building ancillary services such as lighting, air conditioning, heating, and ventilation. It may be noted that for the redundant VSC valve levels and dual/redundant control and protection systems, the losses of redundant VSC valve levels and dual control and protection systems shall be considered during loss measurement.
- C.6.7.3** For the dual or redundant systems design of STATCOM Station, such as dual pumps or redundant fans, dual systems losses are to be excluded, if the dual system is not in service during the normal operation of the STATCOM Station. However, dual systems should be included if they are required to be in service under the defined operating conditions. The same methodology shall be applied for HVAC (heating ventilation and air conditioning systems).
- C.6.7.4** The TSP is required to prepare documentation for the detailed calculation of total losses based on measurement during Factory Acceptance Tests of major equipment and systems mentioned above as per relevant IS/IEC/IEEE standards and the same shall be preserved and to be submitted to CEA/ CTU/ GRID-INDIA, as per their requirement. Further for equipment/systems, whose loss measurement cannot be done during Factory Acceptance Test, the same can be measured at the site, and a combination of calculation and measurement shall be used to derive the total losses as specified above. During Loss measurement, all fans, and pumps; valve room and control room air-conditioning system shall be switched on. However, redundant fans, pumps and air-conditioners shall be kept off during loss measurement
- C.6.7.5** During the factory tests the losses for the following equipment shall be measured/ assessed as detailed below:

Coupling transformer:

Losses shall be measured at factory/lab at the maximum rating, at power frequency as per relevant IEC/IS under below mentioned conditions:

- i. No load loss (Iron loss) at rated voltage and fundamental frequency.
- ii. Load loss (copper loss) at rating corresponding to maximum continuous current and at 75 °C.
- iii. Transformer cooling equipment's loss (Auxiliary loss) at rated voltage and fundamental frequency.

Reactors:

The losses shall be measured at the factory/lab at the maximum rating at power frequency as per relevant IEC/IS.

VSC Valves:

Converter losses comprise the losses in power electronic switches [insulated gate bipolar transistor (IGBT) or equivalent], made up of conduction and switching losses, and the losses in DC capacitors, resistors, and inductors used within the converter system. Refer IEEE-1052 for calculating VSC losses.

Capacitor:

The capacitor losses shall be measured at the manufacturer's works at power frequency as well as calculated to obtain the losses in the complete bank on the basis of factory measurement.

Auxiliary System:

Aux. power losses shall be calculated from the kW and efficiency of all motors (name plate rating) of the cooling system, air conditioning, ventilation etc. The higher of the total losses for the entire auxiliary systems occurring at full capacitive capacity MVar or full Inductive MVar as the case may be shall be considered for arriving at the total losses.

Harmonic Filters, if any:

The losses shall be calculated at the maximum STATCOM Station loading at 400 kV and 50 Hz.

The calculations shall be on the basis of the tested results of the components.

C.6.8 Selection of Insulation Levels

C.6.8.1 Arresters:

Protective levels of arresters connected to the 400 kV AC Bus Bars of the STATCOM Station shall be coordinated with the insulation and surge arrester Characteristics of the 400 kV AC systems to which the STATCOM Station is to be connected. The specification and characteristics of the surge arresters installed in 400 kV AC system is given in the Substation specifications. The front of wave (FWWL), lightning impulse (LIWL) and switching impulse withstand levels (SIWL) shall be determined by the following margins:

- a) A SIWL at least 1.15 times the switching impulse protection level.
- b) A LIWL which is an IEC standard level corresponding to the SIWL and shall be at least 1.25 times the lightning impulse protection level.
- c) A FWWL which is at least 1.25 times the front of wave protection level.

In addition to the above minimum basic requirement, the various insulation level of 400 kV equipment shall be as below. The STATCOM Station equipment, coupling transformers etc. shall be co-ordinated accordingly.

Description	SIWL	LIWL
All equipment including Transformer Bushing and winding	1050 kVp	1425 kVp

C.6.8.2 Valves

The requirement of insulation levels of the valves shall be as per the design requirement.

C.6.8.3 Air clearances

The air clearances shall be determined by the TSP based on the required withstand levels for all waveforms in order to limit the probability of flashover within the STATCOM Station to a target value of one flashover in 15 years.

C.6.8.4 Switchyard

The air clearances for switchyard equipment shall be equal to or greater than the minimum values as specified in IEC-60071. Altitude correction factor (if any) shall also be considered as per IEC.

C.6.8.5 Leakage distances

The Creepage/leakage distance across insulation shall be determined by the TSP and shall be adequate to ensure that under conditions of heavy pollution, the probability of a flashover of an insulator does not exceed one in 15 years. However, the leakage distance for all AC insulators for outdoor installation shall not be less than 25 mm/kV of the maximum operating phase to earth rms voltage at the insulator. The leakage distance of equipment connected to 400 kV systems shall not be less than 10500 mm.

Specific creepage distance for outdoor bushings, insulator strings and long rod insulators shall be a minimum 31 mm/kV.

C.6.9 STATCOM Station availability and reliability

The following definitions apply:

C.6.9.1 Outage terms:

a) Outage

The stage in which equipment is unavailable for normal operation due to an event directly related to the equipment which results in a reduction in STATCOM Station capacity.

b) Scheduled Outage

An outage that can be scheduled at least one week in advance.

c) Forced outage

The stage in which the equipment is unavailable for normal operation but is not in the scheduled outage stage and which results in a reduction in STATCOM Station capacity i.e. an outage which is not scheduled outage.

C.6.9.2 Capacity terms

Maximum Continuous Capacity (Pm)

The maximum STATCOM Station capacity (MVAR) for which continuous operation under normal conditions is possible.

C.6.9.3 Outage duration terms

Actual outage duration (AOD)

The time elapsed in hours between the start and end of an outage.

C.6.9.4 Time Categories

- a) The number of hours in the reporting period in a full year, the period year is 8760 hours. If the equipment is commissioned, part way through a year, the period hours will be proportionately less than 8760 hours.
- b) Total Outage Hour (TOH)
The sum of all outage duration within the reporting period. $TOH = AOD$

C.6.9.5 Availability and Reliability Terms

Unavailability:

Unavailability is the duration for which the STATCOM Station is not available with a specified rating due to forced outages per year. If part of the station is unavailable, then the unavailability duration shall be counted proportionally. However, if STATCOM is out then its duration shall count as a fully unavailable STATCOM Station. However, if the STATCOM unit is out then the STATCOM Station unavailability shall be counted proportionally to STATCOM capacity. STATCOM Station Control system outage shall count as full STATCOM Station unavailability.

‘OF’ is the outage frequency which will be the number of forced outages per year.

The period basis for availability and reliability calculations shall be 12 months. The TSP shall ensure that the design will meet the specified guaranteed and design target value of availability and reliability.

Outage times for repair, maintenance and replacement of components shall be based on the premise that all items in the list of recommended spare parts are on hand, and that all maintenance schedules of recommended maintenance are adhered to. Reliability calculations shall be made and shall be presented as the expected frequency of unscheduled loss of STATCOM Station capacity. For simultaneous occurrence of events, for either of which a loss of capacity would result, the longer repair time shall be counted.

The facilities shall be assumed to be utilized 100% of the time at 100% load, regardless of the actual reactive power generated/absorbed by the STATCOM Station. Hence the availability and reliability assessment will be based on the capability of STATCOM Station to generate/absorb the rated reactive power regardless of whether, it is in service or not.

C.6.9.6 Availability Requirement

The calculated availability of the system considered on an annual basis shall be equal to or exceed the following target values.

Minimum availability requirement of each complete STATCOM Station

- Guaranteed for STATCOM Station - 98%

The outages of STATCOM Station capacity caused by the failure of equipment outside the scope of the TSP shall not be considered for the calculation of availability and reliability guarantee. However, such outages shall be restricted to

- 1) Complete loss to 400 kV supply (at PCC)
- 2) Human Error.

Circumstances causing curtailment of STATCOM Station capacity that will be included in reliability and availability assessment and which can lead to forced outages shall include but not be limited to the following:

- a) Failure of equipment
- b) Mal-operation of control and protection system
- c) Failure to start
- d) Reduction in capacity.

C.6.9.7 Reliability Requirement

- a) Reliability

In the assessment of reliability, the following events shall also be considered to constitute a STATCOM Station outage:

- i) A STATCOM Station shut down.
- ii) A reduction of STATCOM Station capacity due to an outage of any component of STATCOM Station

The calculated reliability of the complete STATCOM Station shall be equal to or exceed the following design target values.

The average outage frequency per year for each STATCOM Station shall not exceed the following values:

	Design target for STATCOM Station	Max acceptable Guaranteed value for STATCOM Station
Total Number of Forced Outages	3 x Nos. of STATCOM	5 x Nos. of STATCOM

	Station	Station
--	---------	---------

C.6.9.8 **GUARANTEED FAILURE RATE OF Sub-modules.** (Including all components and electronic). The maximum annual guaranteed failure rate of sub module (including all components and electronic) shall not exceed 1.0% per STATCOM. The failure rate shall not include failures directly attributable to operation and maintenance errors.

C.6.9.9 **GUARANTEED VALUE OF FAILURE RATE OF AC POWER CAPACITOR**

The maximum guaranteed annual capacitor failure rate shall not exceed 0.15% except for first unit failure. The capacitor shall be considered as failed if its Capacitance value varies more than $\pm 5\%$ of the (actually measured) name plate value. Leakage of oil from the capacitor and the deformation of the capacitor unit shall be considered as a failure even if the capacitance value is within the tolerance limits.

C.7 **Design Principles**

The objective for the design of the STATCOM Station shall be to achieve a high level of availability and reliability as specified. Special attention shall be given to designing the STATCOM Station to avoid forced outages. The TSP shall conduct thorough design reviews to ensure the minimum risk of such outages. The TSP shall give careful attention to related factors affecting STATCOM Station performance such as subsystem and system testing, protective relays co-ordination and proper setting of relays.

Except where greater reliability requirements are specified in these specifications, the design basis for STATCOM Station shall be such that no single contingency downstream from the medium voltage bus shall cause a total outage of the STATCOM Station. The following general criteria shall be followed for the design of the control system:

- a) Use of components similar to those whose reliability has already been proved in use.
- b) Use of good design practices, surge protection, filtering, and interference buffers to assure Immunity to sensitive components and circuits against damage and interference by induced voltages and currents in the external cabling and cubicle wiring.
- c) Use of fail-safe and self-checking design features.
- d) Use of component and equipment redundancy, by means of either duplication or triplication with automatic transfer facilities wherever necessary to meet the requirement of these specifications.

- e) Design which in the event of component failures, provides for transfer to a less complex operating mode.
- f) Provision of alarm, fault diagnosis and indication

C.8 STATCOM Station Main Components

C.8.1 STATCOM Unit

The main electrical data of the STATCOM Units are the following:

- o Rated voltage 20 kV Minimum
- o Rated frequency 50 Hz
- o Redundancy (Sub Module) 2 Nos. or 5% whichever is higher
- o Rated Power of each STATCOM unit/Branch ± 50 MVAR Minimum
- o Valve Cooling Deionized/ Demineralized water

In general, the STATCOM units shall equally share the load however under contingency conditions it should be possible to run the units with unequal load. Charging of the DC capacitors of Sub module during the initial start-up shall be achieved by means of Resistors and bypass breaker arrangement. The charging resistor for DC capacitor of the STATCOM Sub module should be designed for three charges per hour followed by the appropriate cooling time. Power for the gate level control shall be derived internally from Sub module. The offered STATCOM Units with their Control system shall be suitably located inside the STATCOM Station Building.

C.8.1.1 STATCOM Valve

The valve shall be designed to meet the performance requirements described in this specification and as described below.

In order to ensure a modern low loss and reliable solution, the STATCOM valve assembly shall use the multi-module (including redundant sub-modules) approach.

The valves shall be designed to ensure satisfactory operation according to the overall performance requirements and include all necessary auxiliary equipment required for smooth and reliable operation. The valves shall be indoor air-insulated and cooled by demineralized water. The valves shall be of modular design and have removable Sub-Module for ease of maintenance. The valves shall be mounted to allow easy access for visual inspection, routine maintenance and replacement, and facilities shall be provided to enable easy access.

C.8.1.2 Semiconductor Switches

The electronic switches should be designed with the aim to achieve operation according to the overall performance requirements of the STATCOM Station. The valve shall be designed with individual semiconductor switches applied in a conservative manner with regard to their basic design parameters. The semiconductor switch shall meet the requirements of IEC 60747 except where otherwise specified herein.

The semiconductor switches shall be designed to withstand all stresses expected under steady state, transient and temporary overvoltage conditions. Basic semiconductor devices shall be of the Press Pack type, or packaged to provide short circuit means in case of device failure such that the STATCOM can continue to operate without interruption. The adjacent sub-module should be protected against the possible explosion of the semiconductor switch.

Under the restriction of redundancy (minimum two or 5% whichever is higher) i.e. the failure of any semiconductor switch or sub module or monitoring device etc shall not prevent continued system operation. In the event of any of the above failures, the STATCOM shall annunciate and identify the specific location of the failed device and continue operation until such time as repairs can be scheduled. During such time the next shutdown can be availed, the STATCOM must continue to operate without downgrading STATCOM capability.

The switching device's design should include an appropriate allowance for unequal voltage distribution across individual devices in the valve due to the stray capacitor and component tolerances.

The switching device's design should include an appropriate allowance for unequal voltage distribution across individual devices in the valve due to the stray capacitor and component tolerances.

Each switching device should be able to operate within component ratings, generally with at least two failed sub-module or levels. The number of possible failed sub-modules or levels as specified shall be consistent with the availability requirements of the STATCOM system.

C.8.1.3 Sub module for Multi-Module Topology

The key element of the multi-module topology shall be the sub-module. By increasing the number of these sub-modules, it is possible to obtain high voltage with extremely low harmonic distortion and very low dv/dt using a low switching frequency that reduces power losses. Sub-module shall have the following characteristics:

VSC sub-modules should be protected against over voltages with appropriate strategies. A description of the failure mode of the switching device and the strategies used for failure should be provided.

In each fiber optic cable (having multiple fiber cores) used for control/communication purposes of sub-module at least two fiber cores shall remain available as spare for future use.

- C.8.1.4** The STATCOM sub-module has DC capacitors that require a charge to allow full functionality and performance. At the startup of the STATCOM Station, the capacitors are discharged. During the energization sequence of the STATCOM, Capacitors are charged from the main power grid via resistor operated in series to the main connection circuits. Once the desired charging voltages are reached, the charging resistor circuit is bypassed using a bypass switch/breaker.

The Type and Rating of the charging resistor and associated bypass switch shall be designed with the aim to achieve operation according to the overall performance requirements of the STATCOM Station and shall conform to the relevant Standard.

C.8.1.5 STATCOM Valve Cooling System

A closed-loop recirculating system shall be provided with full heat rejection capacity with redundancy for pumps, heat exchangers, and fans, appropriate to the STATCOM Station availability requirements. The cooling system should be able to maintain full capacity at maximum ambient temperature and maximum STATCOM reactive power output. The cooling system should be able to operate at the lowest ambient temperature and zero output specified. The Valve cooling system shall have black start capability and necessary Uninterruptible Power Supply (UPS)/ Uninterruptible Motor Drives (UMD) shall be provided separately for each STATCOM Unit.

The valve cooling system shall be designed to meet the performance requirements described in this specification and as described below.

- a) Each STATCOM Unit shall have its own de-ionized water valve cooling system with redundant pumps.
- b) For cooling the STATCOM valves, a deionized re-circulating (closed loop) water system shall be used.
- c) Water to air heat exchanger shall be used for cooling of this de-ionized water. Water to water heat exchanger shall not be employed.
- d) System shall be designed such that no shut down of STATCOM be resorted to for making up the deionized water in the system. The make-up water should comply with the recommended pH and purity.

- e) Cooling water shall have a constant flow rate irrespective of loading. The flow rate shall be decided on the basis of extreme operating conditions.
- f) The control system for the cooling system shall be redundant type including the provision of redundant control supply and main power supply. However, in place of the redundant control system for the cooling system, suitable alternate mode is also acceptable meeting the requirement of fulfilling cooling system operation even if failure of cooling control system.
- g) 2x100% pumps with one as standby shall be provided for the primary. Should a pump failure occur, the second pump should automatically switch in without shutting down the STATCOM. An alarm shall be displayed at the control panel for the failure of the first pump and standby pump in operation.
- h) Each cooling system shall be provided with an independent/dedicated UMD supply however common battery for both UMD power supply may be accepted. An UMD system will provide an extended capability of the STATCOM Station to deliver reactive power without any interruption, adding a buffer against the system faults or during events such as delayed voltage recovery or Transient over Voltage (TOV).
- i) The secondary cooling system shall be a redundant type such that it shall be possible to take out 10% (minimum one number) of the cooler module (fan unit) of secondary cooling system without affecting the rated performance of STATCOM).
- j) Normally no make-up water shall be required however in case of expansion vessel level going low; the same shall be replenished automatically by means the of make-up water tank and make up water pump to be supplied with the system.
- k) TSP shall provide a water treatment plant of sufficient capacity. The purification (treatment) system shall be designed to maintain conductivity below 1 micro Siemens. A resistivity cell in the outgoing water from the deionizer should detect the depletion of ionized material. Filters and deionizers shall be designed to allow replacement during operation. Normal replacement shall not be required more than once every year.
- l) Filters and deionizer/deoxidizer material shall be designed to allow replacement within minutes without shutdown of the cooling unit. (Normal replacement should not be required more than once/year).
- m) Primary cooling system shall monitor its own operation and condition of cooling water.
- n) The protection system of the cooling cycle shall have minimum following alarms:
 - i) Depleted deionizing cell
 - ii) Low water resistivity
 - iii) High water temperature

- iv) Primary pump stopped
 - v) Fan stopped
 - vi) Primary pump or fan interlock circuits faulty
 - vii) Primary cycle (Make-up water) tank level low
 - viii) Failure of control supply.
 - ix) UMD/ UPS fault.
- o) Following shutdown alarms/ TRIP shall be provided with cooling system protection. Excessive low water resistivity Excessive high water temperature, complete loss of auxiliary supply to primary pumps, low flow, Low Pressure etc.
- p) The dissipative components of the converter are cooled with deionized water.
- q) The power losses are transferred to the external ambient by means of a deionized water /air heat exchanger. All the piping and other components Complete instrumentation set have been mounted on board in order to check the status of the cooling system:
- Conductivity gauge system.
 - Flow meter equipped with two set points (alarm and trip).
 - Pressure meter
 - Two thermometers for the inlet and two thermometers for the outlet (two set points for alarm and trip)
 - Thermostat
- r) The status of the cooling system is monitored by means of the control system.
- s) Replacement of certain cooling equipment (e.g. pumps, fans, cooler unit etc.), if defective, should be possible while the cooling system still operates.

C.8.1.6 Tests on STATCOM Unit Valve

All applicable tests i.e. Operational Type Tests, Dielectric Type Tests and Test for valve insensitivity to electromagnetic disturbance and Production tests shall be done as per the latest edition of IEC 62927.

C.8.2 STATCOM Station Control equipment and operator interface

C.8.2.1 Control Equipment

The control systems should achieve the functional objectives given in 6.2. The accuracy of voltage should be within $\pm 1\%$ of the reference voltage. The accuracy of the gradient

and linearity of the slope delivered by the STATCOM Station should be defined in relation to the current deviation from the theoretical slope defined in 3.1. The maximum deviation should be less than $\pm 5\%$ of the nominal current.

The control system design shall be based on a single fail criterion i.e. failure of any one component in the system should not result into outage of the complete system. As a minimum, a dual (hot standby) digital programmable controller shall be supplied for each STATCOM unit/branch and STATCOM Station to control the STATCOM, MSRs and MSCs completely including the functions listed as mentioned below:

- a. The controller shall have diagnostic and self-checking features for both itself and for valves, gate firing and drive circuits, interface hardware, and software. This is required to reduce outage times and to facilitate fault finding.
- b. The Controller shall be reprogrammable. The Owner shall have at least the following possibility for changing the following reference and limit values via HMI:
- c. Closed loop Controllers:

The STATCOM Station controller shall have the means to modify the reference set points. This refers to the functionality that will allow all the control parameters to be adjustable within selectable limits and is inclusive of, but not limited to following:

- o Voltage controller
 - o Q controller (reactive power controller).
 - o Supplementary VSC current controller.
 - o Other supplementary control functions.
- d. Sequence Controllers:
The sequence control and open-loop controllers shall include the control of all switchgears and associated control gear and external devices.
 - e. The Controller shall have at least 10% excess I/O capacity to allow future program upgrades to satisfy the changing requirements of the power systems or future extensions to the STATCOM Stations. As a minimum, a control of up to 4 future HV shunt devices (reactors or capacitors) shall be included in the offer.
 - f. All control signals available for remote control must also be available locally so as to ensure that a local operator can operate the STATCOM Station if the communications link between STATCOM Station and remote control centers is lost.
 - g. A changeover switch shall be provided for control of the selection of local or remote control.

- h. TSP shall provide the equipment necessary for the purpose of control, protection and interlocking of all equipment within the scope of supply.
- i. TSP shall be responsible for the design and coordination of control, protection and interlocking system and switching sequences within the STATCOM Station. All necessary interfacing required between AC switchyard equipment and STATCOM Station for the above purpose shall also be included in the scope of TSP.
- j. It is proposed to control STATCOM through a Supervisory Control and Monitoring System (SCADA). All the data shall be acquired through suitable means from the field and various components and control is executed through the redundant HMI. The local STATCOM Station Control system shall consist of a redundant STATCOM Station controller, redundant HMI workstation, Gateway, STATCOM Station Control System Engineering cum Disturbance Recorder (DR), PC which can also be used as standby HMI workstations in case of emergency with associated peripheral equipment such as color laser log Printers, Color laser jet fault record printer, GPS System, Inverter / UPS etc. all interconnected via redundant Ethernet based Station LAN Network. Each workstations and PCs at STATCOM Station shall have at least 19" LED display.
- k. In addition to the above, HMI workstation (identical to HMI Workstation provided in the STATCOM Station control room) should also be provided in the control room of the main 400 kV substation. This HMI workstation should be powered from an independent UPS system adequate enough to provide power to the HMI workstation for a minimum two hours in case of auxiliary power failure.
- l. The control equipment shall satisfy the reliability and availability requirements specified in this specification
- m. All necessary measures shall be taken to ensure satisfactory operation in the presence of harmonic current and voltage, noise and radio interference signals. The equipment shall be designed to operate in the environmental conditions specified in the specification.
- n. There should be a provision for independent operation of MSC/MSR after delinking it with STATCOM controls when STATCOM is out of service due to any reason.
- o. The threshold values for switching the MSC/MSR on/off shall be configurable in all modes of operation.

C.8.2.2 Operator Interface

- a) Each STATCOM Station shall have a SCADA consisting of an HMI which shall provide a Centralized (local) operator control of the STATCOM Station functions. All human interface operations necessary for the control and monitoring of the STATCOM shall be provided at this point.

- b) Any abnormal condition requiring operator action or intervention or maintenance on any of the STATCOM Station subsystems shall be annunciated at the STATCOM Station control room and the Substation control room.
- c) The local HMI shall include the following diagrams as different screens in the display system:
 - i. Complete STATCOM Units and STATCOM Station single line diagram including EHV and MV buses
 - ii. AC Auxiliary supply and distribution
 - iii. DC Auxiliary supply and distribution
 - iv. STATCOM Valve cooling systems
 - v. Interlocking system.
- d) These diagrams shall indicate status, alarms, voltages, currents, etc. The HMI shall provide complete diagnostics on alarm and trip indications as required and discussed in this specification, including SER information.
- e) A facility shall be provided whereby the local HMI features and functions shall be accessible from remote. A remote user shall be able to view screens and change STATCOM Station parameter settings.
- f) As **Siwani** substation where STATCOM Station shall be installed, will be equipped with Sub-Station Automation System (SAS) conforming to IEC 61850, it is required that STATCOM Station control and monitoring shall be integrated with SAS already provided at the main 400 kV Sub-station by the TSP. It is proposed to connect STATCOM Station's SCADA with SAS through a Gateway and the database, configuration etc of the main substation SAS shall be upgraded to incorporate STATCOM Station events, alarms, Controls (both switchgear and control functions of STATCOM Station like the setting of parameters etc.) so that STATCOM Station can be effectively monitored and controlled from main substation SAS and shall be monitored from Load Dispatch Center (WRLDC).

C.8.3 STATCOM Station Protection System

C.8.3.1 Protection system Design

- a) To ensure that faults are cleared within stability critical clearing time, to minimize damage to the plant, and to avoid voltage collapse, loss of load, or load limitations, TSP shall provide a high speed main protection scheme. An independent (having a

separate measurement system) back-up protection scheme shall be provided in the event of the main protection scheme failing or taken out for maintenance.

- b) The STATCOM Station shall be completely self-protecting (unit protection). STATCOM Station shall be protected from damage for all conditions of over-current, overvoltage, excessive reactive power loading, unbalance due to loss of capacitor elements, phase-to-phase and phase-to-ground faults, three phase faults, loss of cooling, semiconductor valve or control malfunction, faults (STATCOM, MV system) in individual primary connected components of the STATCOM, HV system faults, etc. The STATCOM Station shall withstand the maximum fault current for a period of the maximum fault clearing time as specified, considering second contingency cases due to the previously mentioned conditions.
- c) All protection equipment and systems should be properly co-ordinated to prevent incorrect operations of the protection equipment or systems during normal STATCOM Station operation, including anticipated abnormal conditions on the transmission system, as specified. Fail-safe principles should be applied throughout.

C.8.3.2 The basic principle and order of precedence for the control and protection shall be, to take care of the following:

- Correctly identify a fault, problem or error condition,
 - Only if necessary, isolate the minimum number of components, subsystems whenever possible,
 - Utilize degraded modes to the maximum extent possible either directly (no interruption of the STATCOM Station operation) or indirectly (by tripping the STATCOM Station momentarily in order to isolate the branch and re-energization of the STATCOM Station).
 - Trip STATCOM Station and Block.
- a) Failure of the STATCOM Station Interface (SCADA interface) shall not result in a Protection trip of the STATCOM Station. A fail-safe philosophy shall be implemented to allow the STATCOM Station to operate safely and independently from the STATCOM Station Interface (SCADA interface).
 - b) Protection equipment shall be designed and applied to provide maximum discrimination between faulty and healthy circuits.
 - c) The Protection shall be sufficiently sensitive to cater to the full range from maximum to minimum fault level conditions. The Protection shall also be suitable for a system fault level equal to the maximum short circuit capacity of

the substation. All current transformer designs shall be based on these fault levels.

- d) All required protective, control devices, etc including auxiliary instrument transformers and panels, relays, cabling, wiring, indication, and all other associated plant and material necessary for the effective operation of the protection systems shall be supplied and installed by TSP.
- e) The protective relays shall be microprocessor based. Relays shall have approved characteristics and be mounted in dust and moisture-proof cases. The protective relays shall be provided with visual indications for starting, tripping and failure of the protective function. The LEDs shall be reset without opening the covers. The protection relays shall also be equipped with HMI facilities suitable for manual parameter settings and viewing of the settings. Relays with provision for manual operation from outside the case, other than for resetting, are not acceptable. Relay settings shall be visible and readable without having to remove the relay cover. Relays shall be of approved construction and shall be arranged so that adjustments, testing and replacement can be effected with the minimum of time and labor. Auxiliary Relays of the hand reset type, if provided shall be capable of being reset without opening the case. Electrically reset tripping relays shall be provided as necessitated by the system of control, such as for those circuits subject to remote supervisory control.
- f) Relay contacts shall be suitable for making and breaking the maximum currents which, they may be required to control in normal service but where contacts of the protective relays are unable to deal directly with the tripping currents, approved Auxiliary tripping relays shall be provided. In such cases, the number of auxiliary tripping relays operating in tandem shall be kept to a minimum in order to achieve fast and reliable fault clearance times. Separate contacts shall be provided for alarm and tripping functions. Relay contacts shall make firmly without bounce and the whole of the relay mechanisms shall be as far as possible unaffected by vibration or external magnetic fields
- g) Steps shall be taken to protect the circuitry from externally impressed transient voltages which could reach the circuitry via connections to instrument transformers or the station battery. The routing of cables should be such as to limit interference to a minimum. Any auxiliary supplies necessary to power solid-state circuits shall be derived from the main station battery and not from batteries internal to the protection.
- h) **Relay communication**
The Relays shall also have a communication port provided on the front of the relay for configuration and parameter settings as well as downloading of data.

A direct port suitable for remote communication shall also be provided at the back of the Relay. This port shall conform to IEC - 61850.

i) **Tripping schemes**

- Tripping of MV circuit breakers shall be done by means of two-separated trip signals.
- Duplicate high security tripping circuits for MV Circuit Breaker shall comprise two independent high speed (less than 10 ms) high burden (greater than 150 W) tripping relays for each circuit, each with its own independent DC supply. The trip circuits for all circuit breakers need to be equipped with a “lockout” function and it shall be possible for this to be reset manually and remotely by the operator.

j) The protection for the power system is based on a normal switching state and an occurrence of a single fault. This means that faults resulting from maintenance as well as the simultaneous occurrence of two or more faults are not taken into account.

k) The input circuits of the digital protections shall be monitored by means of a plausibility check. If any incorrect information is found, the protection function shall be blocked by the protection system. All protection relays shall have facilities for monitoring trip circuits. Detection of an interruption in the case of a switched on circuit breaker shall be signaled.

l) **Test facilities**

- It shall be possible to test the protective device during operation without causing trips. Links shall be provided for the isolation of individual protection trip circuits and the common protection trip circuit to each circuit breaker trip coil.
- Separate test facilities shall be provided for each current and voltage transformer secondary circuit so as to give access for testing of protection relays and associated circuits. The Test facility to be supplied shall have two selectable positions, a Service and a Test position. In the service Position, the test switch connects CTs and VTs signals to the Relays and trip commands to the circuit breaker trip coils. In the Test Position, the test switch applies a short-circuit to the Current Transformer (CT) secondary windings and open circuits the VT secondary cores and allow injection of secondary current and voltage into the relay. At the same time, the Trip commands to the Circuit Breaker Trip Coils are isolated. The test switch supplied shall be to the Approval of the Owner.

- m) The protection of the electrical system shall be designed and installed in such a way that the failed equipment is disconnected selectively and automatically. All equipment have to remain operative during transient phenomena, which may arise during switching or other disturbances to the system.
- n) **Auxiliary DC Supplies**
- The protection concept has to be designed in a way so that back-up protection is provided at all times. All protection relays shall be configured in a way that failure of one Auxiliary DC system will not affect the relay. If all DC supplies to the controllers are lost, the STATCOM Station breaker must be tripped via the protection panel.
- o) **Electromagnetic Compatibility**
- Electronic Relays and other electronic devices and the ancillary circuits connected to them, such as power supplies, current and voltage transformer secondaries, status or tripping or alarm circuits shall be designed to ensure that they are compatible for use in the hostile electrical environment found in an MV or HV substation.
 - Adequate steps by means of suitable design, shall be taken to prevent Electromagnetic Interference (EMI), (generated by sources such as circuit breakers, disconnectors, lightning, radio or radar emissions, switching contactors in DC circuits etc) or Electrostatic Discharges (ESD) from affecting relay performance or causing damage to components.
 - All relays offered shall therefore have been type-tested to meet the current requirements of IEC Standards with respect to High Frequency disturbance, Fast Transients, Electrostatic Discharge, Radio Frequency Interference testing etc.
- p) List of Protection functions for STATCOM Station

Coupling Transformer Protection:

- i) Biased Differential protection (87T)
- ii) REF protection (64T)
- iii) Overcurrent protection (50, 51)
- iv) Ground Overcurrent (51N)
- v) Over flux protection (HV and MV)
- vi) Transformer mechanical trips

STATCOM MV Bus Protection:

- i) Bus Differential protection (87)

- ii) Ground over current protection (51N), used with a neutral Grounding Transformer
- iii) Under / Over Voltage (59 Ph-Ph) protection
- iv) Over voltage (Open Delta) protection

STATCOM Branch Protection:

- i) Differential protection (87)
- ii) Overload protection (49)
- iii) Overcurrent protection inside delta (50, 51)
- iv) Negative phase sequence protection (46)
- v) STATCOM branch overcurrent protection (50, 51, 50N, 51N)

MSR Branch Protection:

- i) Differential protection (87)
- ii) Ground over current protection (51N)
- iii) Reactor branch unbalance protection (Negative Phase Sequence)
- iv) Thermal Overload protection

MSC Branch Protection:

- i) Ground over current protection (51N)
 - ii) Capacitor Overvoltage (Using current signal) protection.
 - iii) Capacitor unbalance protection (60C)
 - iv) Over current protection (50, 51)
- The protection functions listed above are the minimum set of function to be provided, any additional protection required to fulfill the requirement of the protection system shall also be provided.
 - Further protection functions of individual branch (STATCOM, MSC, MSR) shall trip the respective branch MV CB (Circuit Breaker).
 - All CBs shall be provided with individual Breaker Failure protection relays. Breaker Failure relay shall have the logic based on the current signal or CB close open status.
 - Any fault on MV bus will trip the 400 kV breaker. However, any branch fault shall be cleared by the respective MV branch Circuit Breaker.
 - Protection System for the STATCOM valve portion of the STATCOM station shall be provided in the redundant controllers to isolate the STACOM valve during internal overload/overvoltage, ground fault etc.

C.8.4 STATCOM Station Fault Recording System

An integrated Transient Fault Recording (TFR) System shall be supplied, installed and commissioned. This shall include trigger level settings for analog signal, etc subject to review and comment. Disturbance and event recording facilities are required for local monitoring of the STATCOM following a disturbance on the power system or the STATCOM System. The TFR shall be GPS synchronized.

The following inputs are required:

- All analog signals (output signals) including 3-ph and sequence values of voltage, control.
- All digital signals (control outputs, status indications, commands, alarms, and trip indications). Internal STATCOM Station control signals/variables to be selectable.
- The accuracy of the TFR for event inputs shall be at least 100 μ s (sampling rate of minimum 10 kHz).
- The TFR shall have provision for remote access and retrieval of recorded information onto a PC. For this purpose, a communication link to the substation LAN shall be implemented.
- The remote software application for data retrieval shall be included.
- There shall be multiple channels to view 3-ph and sequence values of voltage, current.
- TFR file shall be viewable in any open source software.

C.8.5 Mechanically Switched Reactor (MSR)

MSR is a fixed source of inductive reactive power connected in shunt to the MV bus of STATCOM Station and switched by means of a circuit breaker (with a control switching device) based on the command from the STATCOM Station control system. The rated capability of MSRs shall be at 400 kV (Referred to as “Point of Common Coupling” or PCC) and in the steady state frequency range of 48.5 Hz - 50.5 Hz. However, The MSR Components shall be designed with the aim to achieve operation according to the overall performance requirements of the STATCOM Station. The individual components of MSR shall be able to withstand the onerous conditions imposed by system overvoltage and harmonics. The MSR consists of 3-ph Air Core Reactor, 3-ph MV Circuit breaker (SF6/ Vacuum type), associated current transformer, 3-ph Disconnecter and associated safety grounding switch. The MSR area shall be fenced and a castle key interlock with safety grounding switch shall be provided for human safety.

Specifications for individual components like Air core reactors etc are provided in the subsequent clause.

C.8.6 Mechanically switched capacitor (MSC)

MSC is a switched 3-phase capacitor bank connected in shunt to the MV bus of STATCOM station and switched automatically by means of a circuit breaker (with control switching device) based on the command from STATCOM Station control system. The rated capability of MSCs shall be at 400 kV (Referred to as “Point of Common Coupling” or PCC) and in the steady state frequency range of 48.5 Hz-50.5 Hz. However, TSP will ensure the corresponding values at PCC (400 kV) for possible operating condition measured at PCC. The MSC Components shall be designed with the aim to achieve operation according to the overall performance requirements of the STATCOM Station. The individual components of MSC shall be able to withstand the onerous conditions imposed by system overvoltages and harmonics. The MSC consists of 3-ph AC power capacitor bank, a current limiting air core reactor as required, 3-ph MV Circuit breaker (SF6/Vacuum type), associated current transformer, 3-ph Disconnecter and associated safety grounding switch. The MSC area shall be fenced and a castle key interlock with safety grounding switch shall be provided for human safety. Specifications for individual components like Capacitors, Air core reactors etc are provided in the subsequent clauses.

C.8.7 Air Core Reactors

- a) Reactors shall be air core, dry type, be suitable for outdoor installation and there shall be no tapping on the reactors. The insulation level shall be adequate and TSP has to ensure proper insulation coordination.
- b) The insulation of the reactor shall be class F and hot spot temperature rise shall not exceed 105 °C above ambient temperature. Winding temperature rise shall not exceed 80 °C above ambient temperature.
- c) The reactor shall be designed to withstand thermal dynamic shocks and mechanical shocks while in service and during erection.
- d) The reactor shall fully conform to the relevant IEC standard.
- e) The reactor shall be designed to withstand overloading due to over voltage as specified and shall also be subjected to excitation by harmonics; the reactor must be able to withstand such events without deterioration in normal life.
- f) The reactors shall be subjected to type and routine tests in accordance with the latest issue of IEC-60076 as appropriate to the type of reactor provided.

- g) Tests on Reactors: The reactors shall be subjected to type and routine tests in accordance with the latest issue of IEC-60076 as appropriate to the type of reactor provided.

C.8.8 AC POWER CAPACITORS

i) General

- a) The capacitor banks shall comprise capacitor units, discharge devices, protection equipment, series reactor as required, earthing switches, suitably connected in series and parallel, mounted at ground level with protected fencing all around. The number, arrangement and connection of capacitor banks shall be designed to suit the requirement of the compensator as a whole. If convenient, the capacitor banks may be used in conjunction with reactors. In this event, the rating of the capacitor shall be adequate to cope up with the harmonic loading. The frequency variations shall also be considered. To limit the peak inrush current for switching in the capacitors, current limiting reactors with parallel connected damping resistors, if required shall be connected in series with shunt capacitor banks.
- b) The capacitors shall be provided with internal-type fuses. Alternatively, the fuseless capacitor is also acceptable.
- c) Fuses shall not melt nor shall deteriorate when subjected to the inrush current during the life of the capacitor bank.
- d) With the capacitor charged to a peak voltage, the fuses associated with the healthy elements shall not melt when carrying the discharge current resulting from a breakdown of an element or from an external short circuit.
- e) Fuses shall be capable of disconnecting a faulty element over a range of voltage across the unit terminals from $0.9 U_n$ to $2.0 U_n$. In addition, if all the elements in the same row of an internally fused capacitor were to fail as a result of a cascading action, the last fuse element to melt shall be capable of successful disconnection with a voltage of not less than 1.5 times.
- f) After fuse operation the fuse assembly shall be able to withstand continuously at least 1.5 times the rated unit voltage U_n across the gap for 10 Seconds.
- g) Fuses shall preferably be of the current limiting type but fuse system shall in any event be designed to ensure that energy released into a faulty capacitor unit is less than the value that will cause rupture or bursting of the container.
- h) The capacitor units shall be the outdoor type. The container of the capacitor shall be of stainless steel.

- i) Each capacitor unit shall be readily accessible and replaceable without disturbing any other unit. The supporting frames shall be designed to provide adequate ventilation to the units.
- j) The dielectric fluid used in the capacitor unit shall be environmentally safe and biodegradable, non-toxic. Polychlorinated Biphenyle (PCB) type dielectric or any of its derivatives shall not be acceptable.

ii) Construction and Design Requirement

- a) The capacitors shall conform to IEC-60871. The capacitors shall be provided with internally mounted discharge resisters with characteristics in accordance with IEC-60871.
- b) The current limiting reactors (as required) shall be dry type and connected in series with the capacitor bank. Suitable lifting lugs shall be provided.
- c) The capacitor enclosure shall have sufficient strength to withstand without damage or loss of life, mechanical load, both in operation and during erection. The loads shall include electromagnetic forces including those during faults external or internal to the capacitor bank, wind loading, forces due to expansion and contraction caused by ambient temperature and load variation, and seismic effects all as specified.
- d) The capacitor units shall be interchangeable in order to reduce the spare requirements and simplify maintenance procedures.
- e) The capacitor stack shall be vibration free. The stack shall have a fixed potential, which is connected to one electrical point in the bank. The stack shall be of galvanized structural steel.
- f) The capacitor racks shall be supplied complete with all capacitor units, insulators, and connections and shall be equipped with lifting lugs/eyes to facilitate assembly into the stacks. The racks shall be constructed of galvanized structural steel. No drilling of galvanized steel shall be allowed. Each rack shall be labeled with the weight of the fully equipped racks, the phase, and the bank of which it forms a part. The maximum and minimum capacitor unit capacitance which may be substituted into the racks as spares shall be suitably identified. Suitable warning labels shall be affixed.
- g) The capacitor shall be specially designed to be suitable for intermittent duty.
- h) The capacitors should comply with the overload capacity as per NEMA Standard.
- i) The capacitor elements shall be vacuum dried inside the case prior to impregnation with dielectric fluid. After impregnation, the capacitor unit shall be sealed immediately upon removal of the impregnated reservoir.

- j) The discharge resistor shall discharge the unit from peak operating voltage to less than 75 Volts within 10 minutes.
- k) The capacitor case shall be made from type 409 stainless steel or equivalent stainless steel with all joints welded and tested for leaks.
- l) All racks and bus insulators as well as the insulators used to insulate each stack of capacitor from ground level shall be pin-cap or post type. The minimum voltage rating shall be 15 kV and low frequency wet withstand voltage of all insulators used to insulate within or between the capacitor rack of a stack shall not be less than three times the actual voltage stress across the insulators. The insulator shall be outdoor type manufactured from wet porcelain. The insulators shall be bolted to the top members of the frame to support electric-grade aluminum buses.
- m) The size and groupings of the individual capacitor units shall be such that a single blown fuse will not cause the voltage across the parallel group to rise by more than 10%.
- n) The redundancy to be provided, shall be as per the requirement specified regarding reliability and availability in the clause mentioned elsewhere.

iii) Capacitor Unit Failure Detection

The stages of capacitor units or element failure detection shall be provided as below:

- a) A three-step unbalanced current protection shall be provided in each capacitor bank to initially generate an alarm when the unbalance limit is reached and finally to trip the bank in case of the limit is exceeded.
- b) The first stage shall generate an alarm and the capacitor unit shall continue in service. It may be assumed that the bank shall be disconnected for maintenance within 2 weeks.
- c) The second stage shall generate a separate alarm and a delayed trip signal which will disconnect the bank after two hours.
- d) The third stage shall cause immediate disconnection of the Capacitor Bank.

iv) Tests on Capacitors

All the tests on capacitor units shall be in accordance with the latest issue of IEC 60871.

C.8.9 Coupling Transformer

The TSP shall provide single phase coupling transformers to operate as 3- phase bank with one unit as a common spare (cold spare) with necessary auxiliary arrangements for stepping down the voltage from 400 kV system to a suitable medium voltage value as required for replacing any one of the faulty phase units without physically shifting the

transformer. The Medium Voltage side of the coupling transformer to couple with the STATCOM shall not be less than 20 kV to ensure optimum power transformation.

The Coupling Transformer shall be designed with the aim to achieve operation according to the overall performance requirements of the STATCOM Station. The transformer should be designed and rated to carry complete capacitive and inductive reactive loading as specified for STATCOM Station including that of mechanically switched capacitors and Reactors etc.), as well as harmonic currents associated with the most onerous operating conditions of STATCOM Station, without loss of life.

The coupling transformer shall be designed in accordance with the most up-to-date experience in STATCOM application and shall incorporate the latest improvements of design currently employed in the industry. The Comprehensive design review of the Coupling Transformer of STATCOM Station shall be carried out by the TSP.

C.8.9.1 General Requirements

The coupling transformer shall be designed electrically and mechanically for operating conditions peculiar to STATCOM Station operation, which shall include, but not be limited to the following:

- a) Electrical insulation problems resulting from the transformer being subjected to voltages of distorted sinusoidal wave shape because of saturation, harmonics, trapped charges in capacitors etc.
- b) The cumulative effect of electro-dynamic forces produced during valve commutation or other short circuit conditions imposed by valve design limitation and valve group operation.
- c) Harmonic currents due to STATCOM operation, with reference to additional stray losses resulting from these harmonic currents.
- d) No generation of uncharacteristic harmonics by the transformers.
- e) Stresses due to normal control operation and other onerous operations such as blocking and de-blocking.
- f) Stress due to the fast response requirement of STATCOM for loading from 100% inductive to 100% capacitive and vice-versa.
- g) Overvoltage stresses for which STATCOM shall be designed as per specification would apply to the transformer also.
- h) All other stresses for which STATCOM Station shall be designed as per specification would apply to the transformer also.

- i) The transformer and all its accessories like Bushings, CTs etc shall be designed to withstand without damage, the thermal and mechanical effects of any external short circuit to earth and of a short circuit across the terminals of any winding for a period of 3 seconds. The short circuit level of the 400 kV system to which the transformer shall be connected, will be as per the maximum short circuit level of the main substation. Short Circuit level of the Coupling Transformer shall be as per the Short Circuit level of the respective Substation. Short circuit level for HV bushing shall be 63 kA for 1 Sec.
- j) The transformer shall be capable of being loaded in accordance with IEC 60076 or the overload conditions as specified whichever is the worst. There shall be no limitation imposed by bushings during its terminal fault.
- k) The transformer shall be capable of withstanding the mechanical stresses caused by symmetrical or asymmetrical faults on any winding.
- l) The transformer should be designed to carry a certain level of direct current consistent with the STATCOM design. To ensure minimum harmonics generation, the saturation flux density of the transformer should be higher than the maximum flux density reached over the full steady state (continuous operating) range; this margin shall be at least 10%. This maximum flux density (over the full steady-state range) is obtained at the highest secondary voltage during any reactive power generation, highest reference voltage, minimum slope, and minimum continuous frequency. The flux density at the highest secondary voltage shall lie in the linear portion of the BH curve of the core. Any harmonic generated by the transformer should be considered for the design of the STATCOM.
- m) All protection class Current Transformers in the coupling transformer shall be of PX/PS type. Other details of these Current Transformers shall be as per protection/metering requirements and shall be decided during detailed engineering. However, the parameters of the Winding Temperature Indicator (WTI) of Current Transformer for each winding shall be as per the Coupling Transformer manufacturer.
- n) Transformers shall be capable of operating under natural cooled conditions up to the specified load. The forced cooling equipment shall come into operation by pre-set contacts of winding temperature indicator and the transformer shall operate as a forced cooling unit initially as Oil Natural Air Forced (ONAF) up to a specified load and then as Oil Forced Air Forced (OFAF). Cooling shall be so designed that during total failure of power supply to cooling fans and oil pumps, the transformer shall be able to operate at full load for at least ten (10) minutes without the calculated winding hot spot temperature exceeding 140 degree Celsius. Transformers fitted with two coolers, each capable of dissipating 50 percent of the heat due to losses at the continuous maximum rating, shall be capable of operating for 20 minutes in the event of failure of the oil circulating pump

or blowers associated with one cooler without the calculated winding hot spot temperature exceeding 140° (degree) Celsius at continuous maximum rating.

- o) The transformer shall be free from any electrostatic charging tendency (ECT) under all operating conditions when all oil circulation systems are in operation. In general, the oil flow speed shall not exceed 1.0 m/sec within winding in the oil flow system of the transformers. The manufacturer shall ensure that there is no electrostatic charging tendency in the design.

The Technical Parameters of the Transformer shall be as below

Sl. No.	Description	Unit	Technical Parameters
1.1	Rated Capacity		
	HV	MVA	To meet the performance requirement and ratings of STATCOM. The transformer shall be suitable for 100% reactive loading
	MV	MVA	
1.2	Voltage ratio (Line to Line)		400 / XX (*)
1.3	Single / Three Phase Design		Single phase
1.4	Applicable Standard		IEC 60076
1.5	Rated Frequency	Hz	50
1.6	Cooling and Percentage Rating at different coolings		ONAN/ONAF/(OFAF or ODAF): 60% / 80%/100% OR ONAN/ONAF1/ONAF2: 60% /80%/100% OR OFAF (with 5 x 25% unit cooler if required)
1.7	Impedance at 75 °C (in percentage)		
	HV–MV		To suit the design requirements.
1.8	Tolerance on Impedance (HV-MV)	%	As per IEC
1.9	Service		Outdoor
1.10	Duty		Continuous Reactive loading
1.11	Overload Capacity		IEC-60076-7
1.12	Temperature rise over 50 °C ambient Temp		

Transmission Service Agreement

Sl. No.	Description	Unit	Technical Parameters
i)	Top oil measured by thermometer	°C	50
ii)	Average winding measured by resistance Method	°C	55
1.13	Windings		
i)	System Fault level		
	HV	kA	63
	MV	kA	To suit the design requirements.
ii)	Lightning Impulse withstand Voltage		
	HV	kVp	1300
	MV	kVp	*
	Neutral	kVp	170
iii)	Switching Impulse withstand Voltage		
	HV	kVp	1050
iv)	One Minute Power Frequency withstand Voltage		
	HV	kVrms	570
	MV	kVrms	*
	Neutral	kVrms	70
v)	Neutral Grounding		Solidly grounded
vi)	Insulation		
	HV		Graded
	MV		Uniform
vii)	Tan delta of winding	%	< 0.5
1.14	Vector Group (3 – ph) (unless specified differently elsewhere)		YNd*
1.15	Tap Changer		Not Applicable
1.16	Bushing		
i)	Rated voltage		
	HV	kV	420
	MV	kV	*
	Neutral	kV	36
ii)	Rated current (Min.)		
	HV	A	*

Transmission Service Agreement

Sl. No.	Description	Unit	Technical Parameters
	MV	A	*
	Neutral	A	*
iii)	Lightning Impulse withstand Voltage		
	HV	kVp	1425
	MV	kVp	*
	Neutral	kVp	170
iv)	Switching Impulse withstand Voltage		
	HV	kVp	1050
v)	One Minute Power Frequency withstand Voltage		
	HV	kVrms	695
	MV	kVrms	*
	Neutral	kVrms	77
vi)	Minimum total creepage distances		
	HV	mm/kV	31
	MV	mm/kV	31
	Neutral	mm/kV	31
vii)	Tan delta of bushings		
	HV	%	Refer Note 2
	MV	%	Refer Note 2
viii)	Max Partial discharge level at Um		
	HV	pC	10
	MV	pC	10
	Neutral		-
1.17	Max Partial discharge level at $1.58 * U_r / \sqrt{3}$	pC	100
1.18	Max Noise level at rated voltage and at principal tap at no load and all cooling Active	dB	80
1.19	Maximum Permissible Losses of Transformers		
i)	Max. No Load Loss at rated	kW	To suit the design

Sl. No.	Description	Unit	Technical Parameters
	voltage and Frequency		requirements.
ii)	Max. Load Loss at maximum continuous current and at 75 ^o C	kW	To suit the design requirements.
iii)	Max. Auxiliary Loss at rated voltage and Frequency	kW	To suit the design requirements.

Notes:

1. No external or internal Transformers / Reactors are to be used to achieve the specified HV/MV impedances.
2. The criteria for Transformer losses shall be “Copper Loss (Load Loss) > Iron Loss (No Load Loss) > Cooler Loss (Auxiliary Loss)”.
3. (*) marked parameters shall be decided based on STATCOM manufacturer’s requirement.

C.8.10 STATCOM Station MV Switchgear

The MV Switchgear shall be designed with the aim to achieve operation according to the overall performance requirements of the STATCOM Station.

C.8.10.1 MV Circuit Breaker

The MV Circuit Breaker shall comply with the relevant IEC standard and all other relevant Standards, and as specified in this specification. They shall satisfy the General Technical Requirements and shall be designed to operate in the environmental conditions specified in this specification.

The Circuit Breaker offered should be of SF6 type/Vacuum type only and of class C2, M2 as per IEC

- i) The circuit breaker shall be complete with terminal connectors, operating mechanism, control cabinets, piping, interpole cable, cable accessories like glands, terminal blocks, marking ferrules, lugs, pressure gauges, density monitors (with graduated scale), galvanised support structure for CB and control cabinets, their foundation bolts and all other circuit breaker accessories required for carrying out all the functions the CB is required to perform.

- ii) All necessary parts to provide a complete and operable circuit breaker installation such as main equipment, terminals, control parts, connectors and other devices whether specifically called for herein or not shall be provided.
- iii) The support structure of the circuit breaker shall be hot dip galvanized. Exposed hardware items shall be hot dip galvanized or Electro-galvanized.
- iv) MV Circuit Breaker shall be equipped with controlled switching with consequent optimization of switching behavior, when used in:
 - Switching of Capacitor Bank
 - Switching of shunt Reactor Bank
- v) Reactor Switching Duty test shall be conducted on MV Circuit Breaker in line with latest edition of IEC 62271-110.
- vi) Type Tested for Back-to-Back Capacitor Bank Switching as per latest edition of IEC 62271-100.
- vii) Routine tests as per IEC: 62271-100 shall be performed on all circuit breakers.
- viii) The medium voltage circuit breakers in any of the branches shall be designed to switch off metallic three phase short circuits only limited by the transformer impedance of the STATCOM System (Coupling transformer) with the initial short circuit current and DC component according to IEC 60909-0. Thereby the worst case time constant where the maximum short circuit peak and DC component occur shall be considered. The network shall be considered to deliver the maximum short circuit power of the substation.

C.8.10.2 MV Isolator and Earth Switch

The isolators and earth switches shall comply with the IEC and all other relevant Standards, and as specified in this specification. They shall satisfy the General Technical Requirements and shall be designed to operate in the environmental conditions specified in this specification.

- i) The isolators and accessories shall conform in general to IEC-62271 series as per relevance (or IS:9921) except to the extent explicitly modified in specification.
- ii) Earth switches shall be provided on isolators wherever called for.
- iii) Switches shall be motor operated with local and remote operation features and local manual operation features. Remote operation of Earth Switch is not required.

- iv) Disconnections and earth switches shall electrically and mechanically be interlocked. Castle Key interlocking facilities shall be provided to mechanically interlock the earth switch and Isolator to the doors of valve rooms.

C.8.10.3 Instrument Transformers for STATCOM Station

The instrument transformers shall comply with the relevant IEC Standards. They shall satisfy the general Technical Requirement specified in the specification and shall be designed to operate in the environmental conditions specified in this Specification. The instrument transformers provided for control, metering and protective relaying functions shall have voltage and current ratings, accuracy ratings and burden capabilities adequate to provide their designated functions within the overall accuracy requirement of the systems.

Voltage Transformers

Voltage transformers shall comply with the relevant IEC standards IEC 61869 (Part-1, Part-3 and Part-5).

Current Transformers

Current transformers shall comply with IEC 61869 (Part-1 and Part-2). Type tests and routine tests as per relevant IEC.

C.8.10.4 Surge Arrester

TSP shall install the surge arresters necessary for the protection of the equipment associated with the STATCOM Station in accordance with the requirements as per the insulation coordination study. The surge arresters shall give consistent protection to their associated equipment against overvoltage produced by lightning or switching surges, internal or external station faults, and other system disturbances.

The surge arresters shall be rated such that they are able to discharge a specified maximum energy due to the application of lightning, switching surges, temporary over voltages and faults as determined by insulation coordination studies, without coming into the temperature region where thermal runaway could result upon subsequent application of maximum transient and steady state voltage conditions.

The arrester housing shall be porcelain/composite type. The end fittings shall be made of non-magnetic and corrosion proof material.

Internal components shall be designed to eliminate internal corona and also to ensure minimal capacitive coupling with any conducting layer of pollutant on the outside of the porcelain housing. Particular attention shall be given to the high discharge currents

which some of the arresters may experience in service due to discharge of stored energy of the AC filter and reactive compensating equipment, tripping of STATCOM etc.

C.8.11 STATCOM Station Auxiliary Power Supply

The auxiliary supply of STATCOM Station shall conform with the system requirements relating to reliability, availability, and redundancy, performing continuously to help ensure that the complete STATCOM Station operates as per the requirements. STATCOM station Auxiliary supply including all necessary switchgear (viz. AC/DC, lighting boards etc.) shall be completely separate from the main 765/400/220 kV substation auxiliary supply, all loads of STATCOM station shall be fed from this supply. The auxiliary supply provides power to the controllers, cooling system, station supplies, and various other essential and non-essential loads. With the exception of the cooling system, all other essential loads are also connected to the DC system of the STATCOM Station which is also to be provided separately from the DC system of the main 765/400/220 kV substation.

The auxiliary supply system shall be able to provide a stable supply for the STATCOM Station during system faults such as single-phase faults, phase-to-phase faults, and three-phase faults and LVRT (Low Voltage Ride Through) to allow continuous operation of the STATCOM Station during these transient events.

The auxiliary supply system of each STATCOM Station shall consist of two main incomers and one emergency incomer from DG set. The two main incomers shall be required to be paired to act redundantly to help ensure a certain degree of reliability and availability. One of the main incomers shall be supplied from 33 kV tertiary winding of 765/400/33 kV or 400/220/33 kV ICT at the main substation.

The other main incomer can be supplied from any one of the following three options:

- Supplied from Tertiary/Yoke winding of STATCOM coupling Transformer.
- Supplied from MV Bus Bar of STATCOM Station.
- Supplied from Power PT on HV side of coupling Transformer.

Wherever the Voltage variation on the incomer is very high, a solid state AVR (Automatic Voltage Regulator) shall be provided to control the auxiliary supply voltage.

All MV incomers shall be provided with suitable CB, disconnecter, instrument Transformer etc along with necessary protection system.

C.8.12 Fire Protection System for STATCOM Station:

Necessary fire protection for STATCOM units, Coupling Transformer, MSC, MCR and Harmonic filter (if any) shall be required. The main features of these protections are as under.

Fire Detection and Alarm System:

Suitable fire detection system using smoke detectors and/or heat detectors shall be provided in STATCOM Station for all room and areas. These smoke fire detection systems shall be connected to a separate Fire annunciation system clearly identifying the zone.

Hydrant System:

The hydrant system shall be extended from fire fighting system of the substation in the yard. Suitable number of hydrants shall be provided for protection of STATCOM Station equipment in the yard namely Coupling Transformer, MSCs, MSRs and Harmonic Filter (if required) etc as applicable for the station. Further suitable number of hydrants shall also be provided for STATCOM Station building

HVW System:

HVW (High Velocity Water) Spray system shall be provided for coupling transformer. The tapping for HVW system shall be done from nearby transformer/Reactor or any other suitable point of the main substation fire-fighting line-

Fire protection system shall be provided in accordance with the Central Electricity Authority (Measures relating to Safety and Electric Supply) Regulations, 2023.

C.8.13 Air-conditioning and ventilation system for STATCOM station

The STATCOM Station shall be provided with Air conditioning system as per requirement.

1) AC System (Except Valve Hall):

Air condition system shall be provided for the following rooms in the STATCOM Building:

- a. Control and Relay room
- b. Battery room
- c. Conference Room
- d. Store cum workshop

- e. Cooling system room
- f. Lobby

Capacity and quantity of the AC units shall be decided based on heat load calculation and redundancy requirement.

2) Air-Conditioning System for Valve hall:

Air-Conditioning shall be provided for each Valve room for maintaining the following inside conditions round the year:

DBT - 35 °C (Maximum) Relative Humidity (RH) - 60% (Maximum)

The system shall be designed for an outside ambient temperature of 50 °C. Based on the above system design and parameters for valve room the AC system shall comprise “AHU and Air-cooled DX Condensing units” with one Main and one Standby unit for each room. The system shall be designed for 24 Hours, 365 Days of the year operation to maintain the inside temperatures of the Valve Hall for proper operation of the critical equipment. The air-cooled condensing unit shall be designed for continuous duty.

C.9 Engineering studies

The TSP shall carry out studies as brought out in this section with a model of the STATCOM in PSSE and PSCAD and documentation of the same shall be preserved and to be submitted to CEA/CTU, as per their requirement. The objective of these studies is to verify the steady state requirement of reactive power under normal and contingent operating conditions for peak and light loads conditions in the network.

The studies shall have to be carried out for

- Peak Load
- Light Load
- Contingency Conditions

The load flow and dynamic file available with CTU shall be provided to the TSP in PSSE version 34 format. If data is not available typical data shall be assumed by TSP.

The studies should demonstrate that the STATCOM system meets all system and equipment specified performance criteria as per the specification. Engineering studies should include, but not be limited to, the studies described in subsequent subsections.

C.9.1 System dynamic performance studies

Dynamic performance studies should verify that the STATCOM system controls the system's dynamic performance during system disturbances. Dynamic performance studies include the following:

- a. Studies verifying that the STATCOM provides adequate dynamic control to meet the system and STATCOM system performance criteria for the system conditions.
- b. Study of response time and of the STATCOM system's behavior and contribution to the system's recovery from faults.
- c. Studies to verify the operation of any supplementary controls designed to damp power oscillations following system disturbances.
- d. Studies to evaluate the interaction of the STATCOM controls with the other nearby control systems, including high-voltage direct current (HVDC) controls, generator controls, and controls of other flexible AC transmission systems (FACTS) devices

In addition to the above, relevant studies shall include the cases stated as mentioned in Annexure-I

C.9.2 Harmonic performance

The studies should evaluate resultant maximum harmonic levels at the STATCOM system point of common coupling (PCC), and determine maximum stresses on all STATCOM system components. The study report should include the following:

- a. Evaluation of specified system and operating conditions (refer to Clause 5) under all possible STATCOM operating conditions.
- b. Evaluation within maximum ranges of STATCOM system component tolerances (worst performance values may not occur at detuning extremes).
- c. Evaluation with maximum system voltage unbalance (refers to item 8 and item 9 in Table 3 of Clause 5).
- d. Evaluation of the worst case resonance condition between STATCOM system and overall system.
- e. Evaluation of possible resonant over voltages.
- f. Transformer saturation induced harmonics for component rating calculation only.
- g. Evaluation of impact considering single phase auto reclose deadtime.

C.9.3 Electromagnetic transients, control performance, and overvoltage studies

Transient overvoltage studies should be performed with the actual control modeled to verify that the STATCOM system equipment is adequately protected against over voltages and over currents (including excessive valve recovery voltages) from power

system transients resulting from switching, fault clearing events, and credible STATCOM system maloperations. Evaluation shall include the following:

- a. Study of start-up, including transformer energization, shutdown, switching coordination, and other local area network switching events
- b. Study of STATCOM system protection and protection coordination
- c. Faults on the high-voltage (HV) and MV bus (single line-to-ground, phase-to-phase, and three-phase)
- d. Faults across the VSC, capacitors, and other equipment if used.
- e. Control interaction

C.9.4 Insulation coordination study

Overall insulation coordination should be verified by considering the results of 8.4 (dynamic over voltages, and fault and switching transients), including the impacts of lightning surges on the STATCOM equipment. This study should determine and verify insulation levels, clearances, and arrester placement and ratings.

C.9.5 Other Studies

- a) Grounding Study
- b) Protection coordination
- c) PLC/radio interference
- d) Magnetic field strength
- e) Other studies as applicable

C.9.6 Software simulation models

The TSP shall provide the latest following PSCAD and PSSE simulation model(s) and parameters to CEA/CTU/GRID-INDIA along with detailed documentation for the purpose of future simulation to adequately represent and model the proposed STATCOM system in the respective software:

- a. **Stability model.** TSP should provide a detailed STATCOM system dynamics model for use in (PSCAD and PSSE) power flow and stability simulation software, the model detail should be appropriate and complete for positive-sequence power system simulation and analysis that is typically performed with power flow and transient stability programs. All appropriate control features for such analysis will be modeled, and necessary documentation on the theory and use of model should be provided. Further, a generic

model, benchmarked to detailed STATCOM stability model, shall also be furnished for distribution.

- b. Transients model.** TSP should provide a detailed STATCOM transients model for use in PSCAD. The model detail should be appropriate and complete for the transient response calculation of the STATCOM system. All appropriate control features for such analysis will be modelled, and necessary documentation on the theory and use of model should be provided. Further, a generic model, benchmarked to detailed STATCOM transient model, shall also be furnished for distribution.

PSS/E files may be used for developing RTDS files/ models. For simulation of STATCOM in PSS/E file (load flow and dynamic) and PSCAD (Transient) model for STATCOM is required for study. TSP will share STATCOM models with CEA, CTU and Grid-India along with detailed documentation for above study purposes and simulations. For PSS/E, both Generic and User-defined models shall be shared by the TSP with the CEA, CTU and Grid-India. Generic model (**PSS/E**) response shall be benchmarked with user-defined model (**PSS/E and PSCAD**) to the extent possible by the TSP. Generic models can be shared by the CEA, CTU and Grid-India with the concerned stakeholders/external party(ies) e. g. STUs etc. on need basis. For User Defined model, confidentiality shall be maintained by the CEA, CTU and Grid-India. For PSCAD, User Defined model shall be provided by the TSP for which confidentiality shall be maintained by the CEA, CTU and Grid-India.

Both UDM (PSCAD and PSS/E) and Generic model (PSSE) shall be provided by OEMs to CEA/CTU/GRID-INDIA without any NDA (Non-Disclosure Agreement).

C.9.7 Factory tests of controls

The integrated nature of the performance of the STATCOM in an electrical grid requires the following tests:

- a. The TSP should perform factory simulator system tests for integrated control and protection system to ensure the proper operation of the same. The control system should be connected to a digital simulator with adequate representation of the electrical network for various conditions. The STATCOM system controller needs to be representative of control functions, including basic controllers but inclusive of supplementary controls, firing controls, and protective functions integrated into the controllers. TSP shall submit the FAT (Factory Acceptance Test) reports of STATCOM controls to CTU/RLDC.
- b. The simulator should provide an accurate network representation including network harmonic behavior, as well as synchronous condensers, power stations, generators (with AVRs), and pump storage schemes, existing HVDC, SVCs and STATCOMs, future SVCs and STATCOMs, FSC (fixed series capacitors), and shunt reactors/capacitors/filters.

STATCOM system control function type tests on a simulator should include the following:

- Verification of each control function.
- Verification of control linearity.
- Verification of control redundancy.
- Verification of the monitoring system.
- Verification of the protection system with reference to integrated protective functions included in the Controllers and firing controllers.
- Verification of overall system performance for minor and major system disturbances.
- Verification of processor loading of all digital controllers.
- Verification of STATCOM system parallel operation with other controls in the system and control Stability.
- Verification of control equipment performance for auxiliary power supply voltage (AC and DC) and frequency variations (AC).
- Routine production tests of all control functions, and separately of all protection functions.

C.10.0 VISUAL MONITORING SYSTEM FOR WATCH AND WARD OF STATCOM STATION

Visual monitoring system (VMS) for effective watch and ward of STATCOM station premises covering the areas of entire switchyard, STATCOM building, Coupling Transformer, Cooling Towers and main gate, shall be provided. The TSP shall design, supply, erect, test and commission the complete system including cameras, Digital video recorder system, mounting arrangement for cameras, cables, LAN Switches, UPS and any other items/accessories required to complete the system.

Features of VMS system shall be as those specified for main substation. The number of cameras and their locations shall be decided in such a way that any location covered in the area can be scanned. The cameras shall be located in such a way to monitor at least:

- a) Coupling Transformer, Mechanically Switched Reactors (if any) and Mechanically Switched Capacitors (if any), AC filter banks (if any).
- b) STATCOM Valve Hall, Cooling System, Electrical and Mechanical Auxiliary area.
- c) Entrance to STATCOM Station.
- d) All other Major Equipment (such as CB, CT, VT, SA etc.)

The cameras can be mounted on structures, buildings or any other suitable mounting arrangement.

C.11.0 Spares, Special Tools and Tackles

Considering the STATCOM as high technology proprietary equipment of the OEM, the TSP shall ensure necessary spares are procured to maintain the necessary reliability and availability of STATCOM station. Further all necessary special tools and tackles required for erection, testing, commissioning, and maintenance of equipment shall also be taken.

Contingency Cases for STATCOM

A) N-1 Contingency

Contingency at 765 kV level

1. Three Phase Fault close to 765 kV bus of Bikaner-IV PS followed by tripping of one circuit of Bikaner-IV PS–Siwani 765 kV D/C line (1st) (fault persist for 100 ms)
2. Single Phase to Ground Fault close to 765 kV bus of Bikaner-IV PS followed by single pole opening (100 ms) of the faulted phase and unsuccessful re-closure (dead time 1 second) followed by 3-pole opening (100 ms) of the faulted line i.e. tripping of one circuit of Bikaner-IV PS–Siwani 765 kV D/C line (1st)
3. Three Phase Fault close to 765 kV bus of Siwani S/s followed by tripping of one circuit of Bikaner-IV PS–Siwani 765 kV D/C line (1st) (fault persist for 100 ms)
4. Single Phase to Ground Fault close to 765 kV bus of Siwani S/s followed by single pole opening (100 ms) of the faulted phase and unsuccessful re-closure (dead time 1 second) followed by 3-pole opening (100 ms) of the faulted line i.e. tripping of one circuit of Bikaner-IV PS–Siwani 765 kV D/C line (1st)

Contingency at 400 kV level

5. Three Phase Fault close to 400 kV bus of Bikaner-IV PS followed by tripping of one circuit of Bikaner-IV PS –Bikaner-III PS 400 kV D/C line (fault persist for 100 ms)
6. Single Phase to Ground Fault close to 400 kV bus of Bikaner-IV PS followed by single pole opening (100 ms) of the faulted phase and unsuccessful re-closure (dead time 1 second) followed by 3-pole opening (100 ms) of the faulted line i.e. tripping of one circuit of Bikaner-IV PS –Bikaner-III PS 400 kV D/C line
7. Three Phase Fault close to 400 kV bus of Bikaner-III PS followed by tripping of one circuit of Bikaner-IV PS –Bikaner-III PS 400 kV D/C line (fault persist for 100 ms)
8. Single Phase to Ground Fault close to 400 kV bus of Bikaner-III PS followed by single pole opening (100 ms) of the faulted phase and unsuccessful re-closure (dead time 1 second) followed by 3-pole opening (100 ms) of the faulted line i.e. tripping of one circuit of Bikaner-IV PS –Bikaner-III PS 400 kV D/C line
9. Three Phase Fault close to 400 kV bus of Bikaner-IV PS followed by tripping of one circuit of Bikaner-IV PS –Bikaner-II PS 400 kV D/C line (fault persist for 100 ms)

10. Single Phase to Ground Fault close to 400 kV bus of Bikaner-IV PS followed by single pole opening (100 ms) of the faulted phase and unsuccessful re-closure (dead time 1 second) followed by 3-pole opening (100 ms) of the faulted line i.e. tripping of one circuit of Bikaner-IV PS –Bikaner-II PS 400 kV D/C line
11. Three Phase Fault close to 400 kV bus of Bikaner-II PS followed by tripping of one circuit of Bikaner-IV PS –Bikaner-II PS 400 kV D/C line (fault persist for 100 ms)
12. Single Phase to Ground Fault close to 400 kV bus of Bikaner-II PS followed by single pole opening (100 ms) of the faulted phase and unsuccessful re-closure (dead time 1 second) followed by 3-pole opening (100 ms) of the faulted line i.e. tripping of one circuit of Bikaner-IV PS –Bikaner-II PS 400 kV D/C line
13. Three Phase Fault close to 400 kV bus of Siwani S/s followed by tripping of one circuit of Siwani –Jind(PG) 400 kV D/C line (fault persist for 100 ms)
14. Single Phase to Ground Fault close to 400 kV bus of Siwani S/s followed by single pole opening (100 ms) of the faulted phase and unsuccessful re-closure (dead time 1 second) followed by 3-pole opening (100 ms) of the faulted line i.e. tripping of one circuit of Siwani –Jind(PG) 400 kV D/C line
15. Three Phase Fault close to 400 kV bus of Jind (PG) S/s followed by tripping of one circuit of Siwani –Jind(PG) 400 kV D/C line (fault persist for 100 ms)
16. Single Phase to Ground Fault close to 400 kV bus of Jind (PG) S/s followed by single pole opening (100 ms) of the faulted phase and unsuccessful re-closure (dead time 1 second) followed by 3-pole opening (100 ms) of the faulted line i.e. tripping of one circuit of Siwani –Jind(PG) 400 kV D/C line
17. Three Phase Fault close to 400 kV bus of Siwani S/s followed by tripping of one circuit of Siwani –Patran (Indi Grid) 400 kV D/C line (fault persist for 100 ms)
18. Single Phase to Ground Fault close to 400 kV bus of Siwani S/s followed by single pole opening (100 ms) of the faulted phase and unsuccessful re-closure (dead time 1 second) followed by 3-pole opening (100 ms) of the faulted line i.e. tripping of one circuit of Siwani – Patran (Indi Grid) 400 kV D/C line
19. Three Phase Fault close to 400 kV bus of Patran (Indi Grid) S/s followed by tripping of one circuit of Siwani – Patran (Indi Grid) 400 kV D/C line (fault persist for 100 ms)
20. Single Phase to Ground Fault close to 400 kV bus of Patran (Indi Grid) S/s followed by single pole opening (100 ms) of the faulted phase and unsuccessful re-closure (dead time 1 second) followed by 3-pole opening (100 ms) of the faulted line i.e. tripping of one circuit of Siwani – Patran (Indi Grid) 400 kV D/C line

21. Three Phase Fault close to 400 kV bus of Siwani S/s followed by tripping of one circuit of Siwani –Sonipat(PG) 400 kV D/C line (fault persist for 100 ms)
22. Single Phase to Ground Fault close to 400 kV bus of Siwani S/s followed by single pole opening (100 ms) of the faulted phase and unsuccessful re-closure (dead time 1 second) followed by 3-pole opening (100 ms) of the faulted line i.e. tripping of one circuit of Siwani – Sonipat(PG) 400 kV D/C line
23. Three Phase Fault close to 400 kV bus of Sonipat(PG) S/s followed by tripping of one circuit of Siwani – Sonipat(PG) 400 kV D/C line (fault persist for 100 ms)
24. Single Phase to Ground Fault close to 400 kV bus of Sonipat(PG) S/s followed by single pole opening (100 ms) of the faulted phase and unsuccessful re-closure (dead time 1 second) followed by 3-pole opening (100 ms) of the faulted line i.e. tripping of one circuit of Siwani – Sonipat(PG) 400 kV D/C line
25. Three Phase Fault close to 400 kV bus of Siwani S/s followed by tripping of one circuit of Siwani –Fatehabad(PG) 400 kV D/C line (fault persist for 100 ms)
26. Single Phase to Ground Fault close to 400 kV bus of Siwani S/s followed by single pole opening (100 ms) of the faulted phase and unsuccessful re-closure (dead time 1 second) followed by 3-pole opening (100 ms) of the faulted line i.e. tripping of one circuit of Siwani – Fatehabad(PG) 400 kV D/C line
27. Three Phase Fault close to 400 kV bus of Fatehabad(PG) S/s followed by tripping of one circuit of Siwani – Fatehabad(PG) 400 kV D/C line (fault persist for 100 ms)
28. Single Phase to Ground Fault close to 400 kV bus of Fatehabad(PG) S/s followed by single pole opening (100 ms) of the faulted phase and unsuccessful re-closure (dead time 1 second) followed by 3-pole opening (100 ms) of the faulted line i.e. tripping of one circuit of Siwani – Fatehabad(PG) 400 kV D/C line
29. Three Phase Fault close to 400 kV bus of Jind(PG) S/s followed by tripping of one circuit of Jind(PG)-Kirori 400 kV D/C line (fault persist for 100 ms)
30. Single Phase to Ground Fault close to 400 kV bus of Jind(PG) S/s followed by single pole opening (100 ms) of the faulted phase and unsuccessful re-closure (dead time 1 second) followed by 3-pole opening (100 ms) of the faulted line i.e. tripping of one circuit of Jind(PG)-Kirori 400 kV D/C line
31. Three Phase Fault close to 400 kV bus of Kirori S/s followed by tripping of one circuit of Jind(PG)-Kirori 400 kV D/C line (fault persist for 100 ms)
32. Single Phase to Ground Fault close to 400 kV bus of Kirori S/s followed by single pole opening (100 ms) of the faulted phase and unsuccessful re-closure (dead time 1

- second) followed by 3-pole opening (100 ms) of the faulted line i.e. tripping of one circuit of Jind(PG)-Kirori 400 kV D/C line
33. Three Phase Fault close to 400 kV bus of Patran(Indi Grid) S/s followed by tripping of one circuit of Patran(Indi Grid)-Kaithal 400 kV D/C line (fault persist for 100 ms)
 34. Single Phase to Ground Fault close to 400 kV bus of Patran(Indi Grid) S/s followed by single pole opening (100 ms) of the faulted phase and unsuccessful re-closure (dead time 1 second) followed by 3-pole opening (100 ms) of the faulted line i.e. tripping of one circuit of Patran(Indi Grid)-Kaithal 400 kV D/C line
 35. Three Phase Fault close to 400 kV bus of Kaithal S/s followed by tripping of one circuit of Patran(Indi Grid)-Kaithal 400 kV D/C line (fault persist for 100 ms)
 36. Single Phase to Ground Fault close to 400 kV bus of Kaithal S/s followed by single pole opening (100 ms) of the faulted phase and unsuccessful re-closure (dead time 1 second) followed by 3-pole opening (100 ms) of the faulted line i.e. tripping of one circuit of Patran(Indi Grid)-Kaithal 400 kV D/C line
 37. Three Phase Fault close to 400 kV bus of Sonipat(PG) S/s followed by tripping of one circuit of Sonipat(PG)-Bahadurgarh 400 kV D/C line (fault persist for 100 ms)
 38. Single Phase to Ground Fault close to 400 kV bus of Sonipat(PG) S/s followed by single pole opening (100 ms) of the faulted phase and unsuccessful re-closure (dead time 1 second) followed by 3-pole opening (100 ms) of the faulted line i.e. tripping of one circuit of Sonipat(PG)-Bahadurgarh 400 kV D/C line
 39. Three Phase Fault close to 400 kV bus of Bahadurgarh S/s followed by tripping of one circuit of Sonipat(PG)-Bahadurgarh 400 kV D/C line (fault persist for 100 ms)
 40. Single Phase to Ground Fault close to 400 kV bus of Bahadurgarh S/s followed by single pole opening (100 ms) of the faulted phase and unsuccessful re-closure (dead time 1 second) followed by 3-pole opening (100 ms) of the faulted line i.e. tripping of one circuit of Sonipat(PG)-Bahadurgarh 400 kV D/C line
 41. Three Phase Fault close to 400 kV bus of Fatehabad(PG) followed by tripping of one circuit of Khedar –Fateh bad(PG) 400 kV D/C line (fault persist for 100 ms)
 42. Single Phase to Ground Fault close to 400 kV bus of Fatehabad(PG) followed by single pole opening (100 ms) of the faulted phase and unsuccessful re-closure (dead time 1 second) followed by 3-pole opening (100 ms) of the faulted line i.e. tripping of one circuit of Khedar– Fatehabad(PG) 400 kV D/C line

43. Three Phase Fault close to 400 kV bus of Khedar followed by tripping of one circuit of Khedar –Fatehabad(PG) 400 kV D/C line (fault persist for 100 ms)
44. Single Phase to Ground Fault close to 400 kV bus of Khedar followed by single pole opening (100 ms) of the faulted phase and unsuccessful re-closure (dead time 1 second) followed by 3-pole opening (100 ms) of the faulted line i.e. tripping of one circuit of Khedar– Fatehabad(PG) 400 kV D/C line

Contingency at 220 kV level

45. Three phase fault close to 220 kV Bikaner-IV PS bus with Tripping of 300 MW generation at 220 kV Bikaner-IV PS bus
46. Three phase fault close to 400 kV Bikaner-IV PS bus, with Tripping of 900 MW generation at 400 kV Bikaner-IV PS bus

B) N-1-1 Contingency

Contingency at 765 kV level

47. Case 1 + Single Phase Fault close to 765kV bus of Bikaner-IV PS followed by single pole opening (100 ms) of the faulted phase and successful re-closure (dead time 1 second) of Bikaner-IV – Siwani 2nd ckt.
48. Case 3 + Single Phase Fault close to 765kV bus of Siwani S/s followed by single pole opening (100 ms) of the faulted phase and successful re-closure (dead time 1 second) of Bikaner-IV – Siwani 2nd ckt.
49. Case 3 + Single Phase Fault close to 400 kV bus of Siwani followed by single pole opening (100 ms) of the faulted phase and unsuccessful re-closure (dead time 1 second) followed by 3-pole opening (100 ms) of the faulted line i.e. one circuit of Siwani- Jind(PG) 400 kV D/C line
50. Case 3 + Single Phase Fault close to 400 kV bus of Siwani followed by single pole opening (100 ms) of the faulted phase and unsuccessful re-closure (dead time 1 second) followed by 3-pole opening (100 ms) of the faulted line i.e. one circuit of Siwani- Patran (Indi Grid) 400 kV D/C line
51. Case 3 + Single Phase Fault close to 400 kV bus of Siwani followed by single pole opening (100 ms) of the faulted phase and unsuccessful re-closure (dead time 1 second) followed by 3-pole opening (100 ms) of the faulted line i.e. one circuit of Siwani- Sonipat(PG) 400 kV D/C line
52. Case 3 + Single Phase Fault close to 400 kV bus of Siwani followed by single pole opening (100 ms) of the faulted phase and unsuccessful re-closure (dead time 1

second) followed by 3-pole opening (100 ms) of the faulted line i.e. one circuit of Siwani- Fatehabad (PG) 400 kV D/C line

Contingency at 400 kV level

53. Case 5+ Single Phase Fault close to 400 kV bus of Bikaner-IV PS followed by single pole opening (100 ms) of the faulted phase and unsuccessful re-closure (dead time 1 second) followed by 3-pole opening (100 ms) of the faulted line i.e. 2nd circuit of Bikaner-IV PS –Bikaner-III PS 400 kV D/C line
54. Case 7+ Single Phase Fault close to 400 kV bus of Bikaner-III PS followed by single pole opening (100 ms) of the faulted phase and unsuccessful re-closure (dead time 1 second) followed by 3-pole opening (100 ms) of the faulted line i.e. 2nd circuit of Bikaner-IV PS –Bikaner-III PS 400 kV D/C line
55. Case 9+ Single Phase Fault close to 400 kV bus of Bikaner-IV PS followed by single pole opening (100 ms) of the faulted phase and unsuccessful re-closure (dead time 1 second) followed by 3-pole opening (100 ms) of the faulted line i.e. 2nd circuit of Bikaner-IV PS –Bikaner-II PS 400 kV D/C line
56. Case 11 + Single Phase Fault close to 400 kV bus of Bikaner-II PS followed by single pole opening (100 ms) of the faulted phase and unsuccessful re-closure (dead time 1 second) followed by 3-pole opening (100 ms) of the faulted line i.e. 2nd circuit of Bikaner-IV PS –Bikaner-II PS 400 kV D/C line
57. Case 13 + Single Phase Fault close to 400 kV bus of Siwani S/s followed by single pole opening (100 ms) of the faulted phase and unsuccessful re-closure (dead time 1 second) followed by 3-pole opening (100 ms) of the faulted line i.e. 2nd circuit of Siwani –Jind(PG) 400 kV D/C line
58. Case 15 + Single Phase Fault close to 400 kV bus of Jind(PG) S/s followed by single pole opening (100 ms) of the faulted phase and unsuccessful re-closure (dead time 1 second) followed by 3-pole opening (100 ms) of the faulted line i.e. 2nd circuit of Siwani –Jind(PG) 400 kV D/C line
59. Case 17 + Single Phase Fault close to 400 kV bus of Siwani S/s followed by single pole opening (100 ms) of the faulted phase and unsuccessful re-closure (dead time 1 second) followed by 3-pole opening (100 ms) of the faulted line i.e. 2nd circuit of Siwani –Patran(Indi Grid) 400 kV D/C line
60. Case 19 + Single Phase Fault close to 400 kV bus of Patran(Indi Grid) S/s followed by single pole opening (100 ms) of the faulted phase and unsuccessful re-closure (dead time 1 second) followed by 3-pole opening (100 ms) of the faulted line i.e. 2nd circuit of Siwani – Patran(Indi Grid) 400 kV D/C line

61. Case 21 + Single Phase Fault close to 400 kV bus of Siwani S/s followed by single pole opening (100 ms) of the faulted phase and unsuccessful re-closure (dead time 1 second) followed by 3-pole opening (100 ms) of the faulted line i.e. 2nd circuit of Siwani –Sonipat(PG) 400 kV D/C line
62. Case 23+ Single Phase Fault close to 400 kV bus of Sonipat(PG) S/s followed by single pole opening (100 ms) of the faulted phase and unsuccessful re-closure (dead time 1 second) followed by 3-pole opening (100 ms) of the faulted line i.e. 2nd circuit of Siwani – Sonipat(PG) 400 kV D/C line
63. Case 25 + Single Phase Fault close to 400 kV bus of Siwani S/s followed by single pole opening (100 ms) of the faulted phase and unsuccessful re-closure (dead time 1 second) followed by 3-pole opening (100 ms) of the faulted line i.e. 2nd circuit of Siwani –Fatehabad (PG) 400 kV D/C line
64. Case 27 + Single Phase Fault close to 400 kV bus of Fatehabad (PG) S/s followed by single pole opening (100 ms) of the faulted phase and unsuccessful re-closure (dead time 1 second) followed by 3-pole opening (100 ms) of the faulted line i.e. 2nd circuit of Siwani – Fatehabad(PG) 400 kV D/C line
65. Case 29 + Single Phase Fault close to 400 kV bus of Jind(PG) followed by single pole opening (100 ms) of the faulted phase and unsuccessful re-closure (dead time 1 second) followed by 3-pole opening (100 ms) of the faulted line i.e. 2nd circuit of Jind(PG)-Kirori 400 kV D/C line
66. Case 31 + Single Phase Fault close to 400 kV bus of Kirori S/s followed by single pole opening (100 ms) of the faulted phase and unsuccessful re-closure (dead time 1 second) followed by 3-pole opening (100 ms) of the faulted line i.e. 2nd circuit of Jind(PG)-Kirori 400 kV D/C line
67. Case 33 + Single Phase Fault close to 400 kV bus of Patran(Indi Grid) followed by single pole opening (100 ms) of the faulted phase and unsuccessful re-closure (dead time 1 second) followed by 3-pole opening (100 ms) of the faulted line i.e. 2nd circuit of Patran(Indi Grid)-Kaithal 400 kV D/C line
68. Case 35 + Single Phase Fault close to 400 kV bus of Kaithal followed by single pole opening (100 ms) of the faulted phase and unsuccessful re-closure (dead time 1 second) followed by 3-pole opening (100 ms) of the faulted line i.e. 2nd circuit of Patran(Indi Grid)-Kaithal 400 kV D/C line
69. Case 37 + Single Phase Fault close to 400 kV bus of Sonipat(PG) followed by single pole opening (100 ms) of the faulted phase and unsuccessful re-closure (dead

time 1 second) followed by 3-pole opening (100 ms) of the faulted line i.e. 2nd circuit of Sonipat(PG)-Bahadurgarh 400 kV D/C line

70. Case 39 + Single Phase Fault close to 400 kV bus of Bahadurgarh followed by single pole opening (100 ms) of the faulted phase and unsuccessful re-closure (dead time 1 second) followed by 3-pole opening (100 ms) of the faulted line i.e. 2nd circuit of Sonipat(PG)-Bahadurgarh 400 kV D/C line
71. Case 41 + Single Phase Fault close to 400 kV bus of Fatehabad(PG) followed by single pole opening (100 ms) of the faulted phase and unsuccessful re-closure (dead time 1 second) followed by 3-pole opening (100 ms) of the faulted line i.e. 2nd circuit of Khedar –Fatehabad(PG) 400 kV D/C line
72. Case 43 + Single Phase Fault close to 400 kV bus of Khedar followed by single pole opening (100 ms) of the faulted phase and unsuccessful re-closure (dead time 1 second) followed by 3-pole opening (100 ms) of the faulted line i.e. 2nd circuit of Khedar –Fatehabad(PG) 400 kV D/C line
73. Case 13+ Single Phase Fault close to 765 kV bus of Bikaner-IV PS followed by single pole opening (100 ms) of the faulted phase and successful re-closure (dead time 1 second) of Bikaner-IV – Siwani one ckt (out of four ckts)
74. Case 15+ Single Phase Fault close to 765 kV bus of Bikaner-IV PS followed by single pole opening (100 ms) of the faulted phase and successful re-closure (dead time 1 second) of Bikaner-IV – Siwani one ckt (out of four ckts)
75. Case 17+ Single Phase Fault close to 765 kV bus of Bikaner-IV PS followed by single pole opening (100 ms) of the faulted phase and successful re-closure (dead time 1 second) of Bikaner-IV – Siwani one ckt (out of four ckts)
76. Case 19+ Single Phase Fault close to 765 kV bus of Bikaner-IV PS followed by single pole opening (100 ms) of the faulted phase and successful re-closure (dead time 1 second) of Bikaner-IV – Siwani one ckt (out of four ckts)

STATCOM Station shall be capable of ride through for multiple voltage dips within pre-defined time window as per following curve:

Transmission Service Agreement

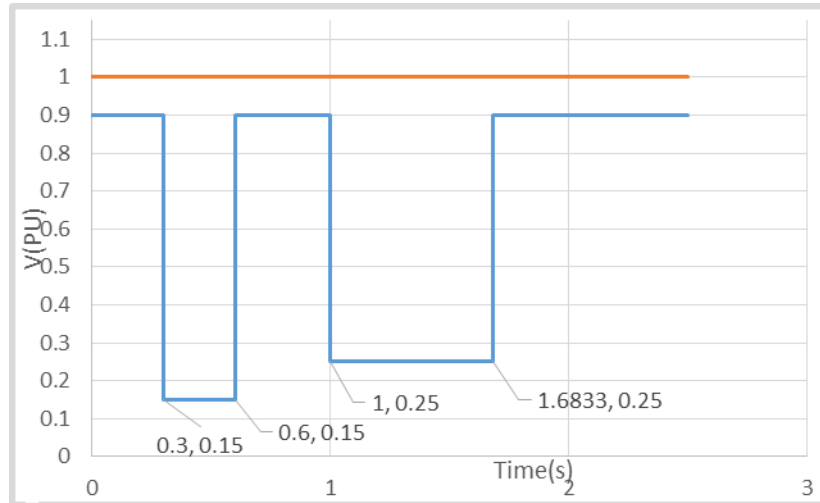

Note:

1. In the 'N-1-1' as stated above, if there is a temporary fault, the system shall not lose the second element after clearing of fault but shall successfully survive the disturbance.
2. In case of permanent fault, the system shall lose the second element as a result of fault clearing and thereafter, shall asymptotically reach to a new steady state without losing synchronism. In this new state, the system parameters (i.e. voltages and line loadings) shall not exceed emergency limits, however, there may be requirement of load shedding / rescheduling of generation so as to bring system parameters within normal limits.

SPECIFIC TECHNICAL REQUIREMENTS FOR COMMUNICATION

The communication requirement shall be in accordance to CEA (Technical Standards for Communication System in Power System Operations) Regulations, 2020, CEA (Technical Standards for Construction of Electrical Plants and Electric Lines) Regulations, 2022, CERC (Communication System for inter-State transmission of electricity) Regulations, 2017, and CEA (Cyber Security in Power Sector) Guidelines, 2021, all above documents as amended from time to time.

The communication services viz. SCADA, AGC (wherever applicable), VoIP, AMR and PMU have been identified as critical services and therefore shall be provisioned with 2+2 redundancy i.e. 2 channels for Main Control Centre and 2 channels for Backup Control Centre. In order to meet this requirement, suitable redundancy at port and card level need to be ensured by the TSP to avoid any single point of failure which may lead to interruption in real-time grid operation.

PMU to PDC communication (wherever required) shall be through 2 channels to the PDC (main) as there is no backup PDC at present.

Accordingly all the hardware for communication services of station as stated above shall support dual redundancy for data transmission of station to respective main and backup RLDCs

The complete ISTS communication system commissioned by TSP under the RFP shall be the asset of ISTS and shall be available for usage of ISTS requirements as suggested by CTU from time to time.

In order to meet the requirement for grid management and operation of substations, Transmission Service Provider (TSP) shall provide the following:

D.1.0 Establishment of 765/400 kV Siwani S/s

- (i) TSP shall supply, install and commission 1 No. FODP (96F or higher) and 1 No. FODP (24F or higher) along with panel and approach Cable (24F each) with all associated hardware fittings from gantry tower to Control Room for all the incoming lines envisaged under the present scope.
- (ii) TSP shall supply, install and commission One or more STM-16 (FOTE) equipment alongwith panel/s supporting minimum Five (5) directions with MSP (Multiplex Section Protection – 1+1). These directions shall exclude protected (1+1) local patching among equipment (if any). Communication Equipment shall be provided with necessary interfaces to meet the voice and data communication requirement among Siwani S/s, Jind (PG) S/s, Sonipat S/s, Bikaner-IV PS (for 2nd Line). The suitable DC Power Supply and backup to be provided for communication equipment.

- (iii) FODP and FOTE equipment with panels shall be provided in Control Room of Siwani S/s. FOTE and FODP Eq can be accommodated in same panel to optimize space.
- (iv) TSP shall supply, install and commission Firewall in redundant mode (1+1) in line with the specification attached at **Annexure F.1**.
- (v) The maintenance of all the communication equipment and software thereof including FOTE, FODP, PMU, approach cable, DCPS along with Battery Bank and Firewall shall be the responsibility of TSP.

D.2.0 Bikaner-IV PS – Siwani 765 kV D/C (2nd) line

On Bikaner-IV PS – Siwani 765 kV D/C (2nd) line, TSP shall supply, install and commission One (1) No. OPGW cable containing 24 Fibres (24F) on one E/W peak and conventional earth wire on other E/W peak.

The TSP shall install this OPGW from gantry of Bikaner-IV PS up to the gantry of Siwani S/s with all associated hardware including Vibration Dampers, mid-way and gantry Joint Boxes (called **OPGW Hardware** hereafter) and finally terminate in Joint Boxes at end Substations. The transmission line length is **260 kms (approx.)**, where repeater shall be required to meet the link budget requirement of Bikaner-IV PS – Siwani 765 kV link the same shall be provided by TSP.

TSP shall finalize the location of repeater station depending upon the actual site conditions. Further TSP shall comply to the requirements mentioned as per **Appendix-F.1**

Maintenance of OPGW Cable and OPGW Hardware shall be responsibility of TSP.

D.3.0 Siwani – Sonipat (PG) 400 kV D/C line

On Siwani – Sonipat (PG) 400 kV D/C line, TSP shall supply, install and commission One (1) No. OPGW cable containing 24 Fibres (24F) on one E/W peak and conventional earth wire on other E/W peak.

The TSP shall install this OPGW from gantry of Siwani S/s up to the gantry of Sonipat S/s with all associated hardware including Vibration Dampers, mid-way and gantry Joint Boxes (called **OPGW Hardware** hereafter) and finally terminate in Joint Boxes at end

Substations. The transmission line length is **150 kms (approx.)**, where repeater may not required to meet the link budget requirement of Siwani – Sonipat (PG) 400 kV D/C link.

Maintenance of OPGW Cable and OPGW Hardware shall be responsibility of TSP.

D.4.0 Siwani S/s – Jind (PG) 400 kV D/C line

On Siwani S/s – Jind (PG) 400 kV D/C line, TSP shall supply, install and commission One (1) No. OPGW cable containing 24 Fibres (24F) on one E/W peak and conventional earth wire on other E/W peak.

The TSP shall install this OPGW from gantry of Siwani S/s up to the gantry of Jind (PG) with all associated hardware including Vibration Dampers, mid-way and gantry Joint Boxes (called **OPGW Hardware** hereafter) and finally terminate in Joint Boxes at end Substations. The transmission line length is **110 kms (approx.)**, where repeater may not required to meet the link budget requirement of Siwani S/s – Jind (PG) 400 kV D/C link.

Maintenance of OPGW Cable and OPGW Hardware shall be responsibility of TSP.

D.5.0 2 Nos. of 400 kV line bays at Jind (PG)

- (i) TSP shall supply, install and commission 1 No. FODP (72F or higher) alongwith panel and required Approach Cable (24F) with all associated hardware fittings from gantry tower to Bay Kiosk and from the Bay Kiosk to Control room.
- (ii) TSP shall supply, install and commission One STM-16 (FOTE) equipment alongwith panel/s supporting minimum three (3) directions with MSP (Multiplex Section Protection – 1+1) with necessary interfaces to meet the voice and data communication requirement between Siwani S/s and Jind (PG). The suitable DC Power Supply and backup to be provided for communication equipment.
- (iii) FOTE/FODP panel shall be installed in the new Bay Kiosk (Switchyard Panel Room (SPR)). The FOTE under present scope shall be integrated by TSP with the existing FOTE at control room of Jind (PG) S/s which shall be communicating with respective control center. TSP to provide necessary FODP sub rack / Splice trays/ Patch cords etc. and optical interfaces/equipment in the existing FOTE/FODP panels in control room for integration with the existing FOTE for onwards data transmission.

In case spare optical direction is not available in the existing FOTE at the control room, the TSP shall coordinate with station owner to reconfigure the directions in existing FOTE at control room. Alternatively, The TSP may integrate the FOTE under the present scope with existing FOTE in the nearby Kiosk connected to the control room FOTE (if available with spare direction). For this purpose, TSP shall provide necessary FODP sub rack / Splice trays/ Patch cords etc. and suitable optical interfaces/ equipment in the existing FOTE/FODP panels in another Kiosk (SPR).

- (iv) FOTE and FODP can be accommodated in same panel to optimize space.
- (v) The maintenance of all the communication equipment and software thereof including FOTE, FODP, approach cable, PMU, DCPS alongwith Battery Bank shall be the responsibility of TSP.

D .6.0 2 Nos. of 400 kV line bays at Sonipat (PG).

- (i) TSP shall supply, install and commission 1 No. FODP (72F or higher) alongwith panel and required Approach Cable (24F) with all associated hardware fittings from gantry tower to Bay Kiosk and from the Bay Kiosk to Control room.
- (ii) TSP shall supply, install and commission One STM-16 (FOTE) equipment alongwith panel/s supporting minimum three (3) directions with MSP (Multiplex Section Protection – 1+1) with necessary interfaces to meet the voice and data communication requirement Siwani S/s and Sonipat (PG). The suitable DC Power Supply and backup to be provided for communication equipment.
- (iii) FOTE/FODP panel shall be installed in the new Bay Kiosk (Switchyard Panel Room (SPR)). The FOTE under present scope shall be integrated by TSP with the existing FOTE at control room of Sonipat (PG) S/s which shall be communicating with respective control center. TSP to provide necessary FODP sub rack / Splice trays/ Patch cords etc. and optical interfaces/equipment in the existing FOTE/FODP panels in control room for integration with the existing FOTE for onwards data transmission.

In case spare optical direction is not available in the existing FOTE at the control room, the TSP shall coordinate with station owner to reconfigure the directions in existing FOTE at control room. Alternatively, The TSP may integrate the FOTE under the present scope with existing FOTE in the nearby Kiosk connected to the control room FOTE (if available with spare direction). For this purpose, TSP shall provide necessary FODP sub rack / Splice trays/ Patch cords etc. and suitable optical interfaces/ equipment in the existing FOTE/FODP panels in another Kiosk (SPR).

(iv) FOTE and FODP can be accommodated in same panel to optimize space.

(v) The maintenance of all the communication equipment and software thereof including FOTE, FODP, approach cable, PMU, DCPS alongwith Battery Bank shall be the responsibility of TSP.

D.7.0 2 Nos. of 765 kV line bays at Bikaner-IV PS.

(i) TSP shall supply, install and commission 1 No. FODP (72 or higher) along with panel and required Approach Cable (24F) with all associated hardware fittings from gantry tower to Bay Kiosk and from the Bay Kiosk to Control room.

(ii) TSP shall supply, install and commission One STM-16 (FOTE) equipment alongwith panel/s supporting minimum three (3) directions with MSP (Multiplex Section Protection – 1+1) with necessary interfaces to meet the voice and data communication requirement between Bikaner-IV PS and Siwani S/s. The suitable DC Power Supply and backup to be provided for communication equipment.

(iii) FOTE/FODP panel shall be installed in the new Bay Kiosk (Switchyard Panel Room (SPR)). The FOTE under present scope shall be integrated by TSP with the FOTE at control room of Bikaner-IV PS which shall be communicating with respective control center. Optical interfaces for local patching in the control room FOTE of Bikaner-IV PS has been considered under Ph-IV (Part- 3:6 GW) [Bikaner complex]: Part-A project.

(iv) FOTE and FODP can be accommodated in same panel to optimize space.

(v) The maintenance of all the communication equipment and software thereof including FOTE, FODP, approach cable, PMU, DCPS alongwith Battery Bank shall be the responsibility of TSP.

D.8.0 Specific Requirement for Phasor Measurement Units (PMUs)

TSP shall supply, install and commission required No. of Phasor Measurement Units (PMUs) PMUs at all the locations including STATCOMs under the scope of TSP locations under this RFP as per CEA (Technical Standards for Construction of Electrical Plants and Electric Lines) Regulations, 2022 (alongwith all amendments if any), and all the applicable Regulations, Standards, Guidelines issued time to time.

TSP shall also supply, install and commission required No. of Phasor Measurement Units (PMUs) on HV side of coupling transformer at each STATCOM station and integrate with PDC.

These PMUs shall be provided with GPS clock and LAN switch and shall connect with LAN switch of control room of respective substations/ generating stations with Fibre Optic cable. These PMUs shall be connected with the FOTE at Substation/ generating stations for onwards data transmission to the PDC (Phasor Data Concentrator) located at respective RLDC. Configuration work in existing PDC at RLDC for new PMU integration shall be done by respective RLDC, however all the necessary support in this regard shall be ensured by TSP. The maintenance of all the PMUs and associated equipment shall be the responsibility of TSP.

Note: Existing Station owner/s to provide necessary support to integrate different equipment and applications of new extended bays with the existing substation e.g. Communication (through FOTE), Voice etc. for smooth operation and monitoring of new added grid elements.

D.9.0 Specific Requirement for NMS/ UNMS integration

- The new communication equipment/ system under the present scope shall be compatible for integration with existing regional level NMS system/ Centralized Supervision and Monitoring System (CSMS) i.e. Regional UNMS. The local configuration of the new communication equipment at the station end shall be the responsibility of TSP as per Annexure F.3. The configuration work in the existing centralized NMS/ CSMS at Control center end, for integration of new Communication equipment/ system shall be done by Regional ULDC Team/ NMT, however all the necessary support in this regard shall be ensured by TSP.

Appendix-F.1

Repeater Requirements

- 1.1.1 If the repeater location is finalized in the Control Room of a nearby substation, TSP shall provide 1 No. OPGW (48F) on a single Earthwire peak with OPGW Hardware and mid-way Joint Boxes etc. of the line crossing the main line and 1 No. Approach Cable (48F) with all associated hardware fittings, to establish connectivity between crossing point of main transmission line up to the repeater equipment in substation control room.

TSP shall co-ordinate for Space and DC power supply sharing for repeater equipment.

TSP shall provide FODP, FOTE (with STM-16 capacity) with suitable interfaces require for link budget of respective link.

OR

- 1.1.2 If the repeater location is finalized in the nearby substation premises, the TSP shall identify the Space for repeater shelter in consultation with station owner. Further TSP shall provide 1 No. OPGW (48F) on a single Earthwire peak with OPGW Hardware and mid-way Joint Boxes etc. of the line crossing the main line and 1 No. Approach Cable (48F) / UGFO (48F) with all associated hardware fittings, to establish connectivity between crossing point of main transmission line up to the substation where the repeater shelter is to be housed.

TSP shall provide repeater shelter along with FODP, FOTE (with STM-16 capacity) with suitable interfaces require for link budget of respective link, reliable power supply provisioning for AC and DC supply, battery bank, Air Conditioner and other associated systems.

OR

- 1.1.3 If the repeater location is finalized on land near the transmission tower. TSP shall make the provisions for Land at nearby tower for repeater shelter. Further TSP shall provide 1 No. Approach Cable (48F) / UGFO (48F) with all associated hardware fittings to establish connectivity up to the location of repeater shelter.

TSP shall provide repeater shelter along with FODP, FOTE (with STM-16 capacity) with suitable interfaces require for link budget of respective link, reliable power supply provisioning for AC and DC supply, battery bank, Air Conditioner and other associated systems

Maintenance of OPGW Cable and OPGW Hardware, repeater equipment and items associated with repeater shelter shall be responsibility of TSP.

Proposed Communication for “Transmission system for evacuation of power from Rajasthan REZ Ph-IV (Part-3: 6GW) (Bikaner Complex): Part B”

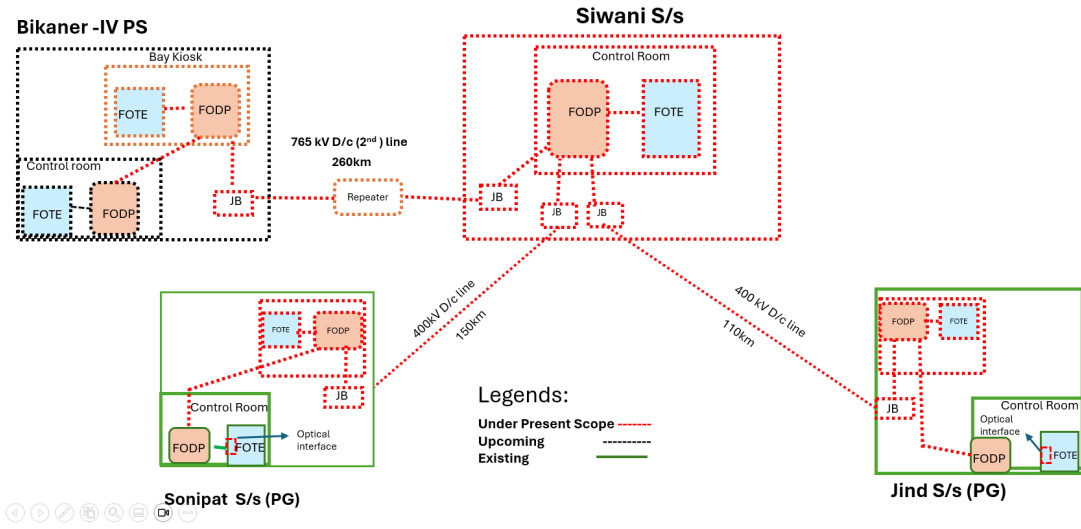

Figure F.1

Annexure-F.1

Next Generation Firewall (NGFW)

TSP shall provide 2 NGFW one in Main and another in Standby mode having electrical ethernet interfaces/ports and placed between FOTE and SAS gateway/s at the substation. All ethernet based applications shall be terminated in the firewall ports directly (e.g. PMU, AMR, VOIP, SAS/SCADA etc.). Each port of firewall shall work as a separate zone. Firewall shall be hardware based with features of Block/Allow/drop and IPSec VPN (network encryption).

The number of ports/interfaces in each firewall (i.e. Main and Standby) shall be minimum 16 Nos. TSP shall provide either single firewall or multiple firewalls to meet this interfaces requirement, each for main as well as standby firewall. Minimum throughput of firewall shall be 300 Mbps.

The Firewall shall be managed/ configured as standalone at present and shall also have compatibility to manage/configure through Centralized Management Console (CMC) remotely in future.

Firewall shall be tested and certified for ISO15408 Common Criteria for least EAL4+. Further, the OEM must certify that it conforms to Secure Product Development Life Cycle requirements as per IEC62443-4-1. The firewall shall generate reports for NERC-CIP Compliance.

The specifications for the firewalls are given at **Annexure-F.2** and schematic diagram showing firewall placement given at **Figure F.2**.

Annexure F.2

Specifications of Next Generation Firewall (NGFW)

1. NGFW shall have following features including but not limited to:
Encryption through IPSec VPN (Virtual Private Network), Deep Packet Inspection (DPI), Denial of service (DoS) and Distributed Denial of Service (DDoS) prevention, Port Block/ Allow, rules/ policies for block/allow, IP (Internet Protocol) and Media Access Control (MAC) spoofing protection, threat detection, Intrusion Prevention System (IPS), Anti-Virus, Anti-Spyware, Man In The Middle (MITM) attack prevention.
2. The proposed firewall shall be able to handle (alert, block or allow) unknown /unidentified applications e.g. unknown TCP and UDP packets. It shall have the provision to define application control list based on application group and/or list.
3. Firewall shall have feature and also have capability to update the definition/ Signatures of Anti-Virus online as well as offline. Firewall shall also be compatible to update the definitions/signatures through CMC. There shall be a defined process for security patching and firmware up-gradation. There shall be a feature to field validate firmware checksum. The same shall also be validated before using the OEM provided file/binary in the process of firmware up-gradation and security patching
4. Firewall shall have Management Console port to configure remotely.
5. Firewall shall be EMI/EMC compliant in Substation environment as per IEC 61850-3.
6. Firewall shall be rack mounted in existing standard equipment cabinets.
7. Firewall shall have support of SCADA applications (IEC-60870-5-104), ICCP, PMU (IEEE C37.118), Sub-Station Automation System (IEC 61850), Ethernet and other substation environment protocols.
8. Client based Encryption/ VPN must support different Operating System platforms e.g. Windows, Linux and Mac.
9. The solution must have content and comprehensive file detection policies, blocking the files as function of their types, protocols and directions.

10. Firewall shall have logging facility as per standard logs/events format. Firewall shall have features to export the generated/stored logs/events in csv (Comma Separated Value) and also any other standard formats for offline usage, analysis and compliance. Firewall shall have suitable memory architecture and solution to store and be able to export all logs/events for a period of last 90 days at any given time.
11. Firewall shall have features and be compatible with local as well as central authentication system (RADIUS, LDAP, or TACACS+) for user account and access right management. It shall also have Role Based User management feature.
12. Firewall shall have the capability to configure sufficient number of VLANs.
13. Firewall shall have the capability to support sufficient number of sessions.
14. Firewall shall have provision to configure multiple IP Sec VPNs, at least 100 Nos., (one-to-many or many-to-one). Shall support redundant operation with a similar router after creation of all the IP Sec VPN. IPsec VPN shall support encryption protocols as AES128, AES256 and hashing algorithms as MD5 and SHA1. IPsec VPN throughput shall support at least 300 Mbps
15. Firewall shall be capable of SNMP v3 for monitoring from Network Management system. It shall also have SNMPv3 encrypted authentication and access security
16. Firewall shall support in Active/Passive or Active-Active mode with High Availability features like load balancing, failover for firewall and IPsec VPN without losing the session connectivity.
17. Firewall should have integrated traffic shaping (bandwidth, allocation, prioritisation, etc.) functionality
18. Shall support simultaneous operation with both IPv4 and IPv6 traffic
19. Firewall shall be compatible with SNTP/NTP or any other standards for clock synchronization
20. Firewall shall have the features of port as well as MAC based security
21. Firewall shall support exporting of logs to a centralized log management system (e.g. syslog) for security event and information management.
22. Firewall time shall be kept synchronised to official Indian Timekeeping agency, time.nplindia.org.

23. Firewall product shall be provided with all applicable updates at least until 36 months since the applicable date of product shipping to the concerned utility.

Annexure F.3

Requirement for integration of Communication Equipment with Regional UNMS:

1. TSP shall ensure that NMS/EMS/NE supplied by them is NBI compliant and all FCAPS functionality is supported in the NBI such as NE Inventory, Hardware Inventory – Shelf/Slot/Card/SFP/Port, Topology, Protections, Alarms, Performance-real time and periodic, Performance KPI parameters (E-1, STM, Ethernet) , Remote Configuration, Cross Connects, Trails and Circuits, Services Provisioning (NE), E-1 , STM, Ethernet , TX and RS Trace, loop back and details are published in the NBI guide for the configuration parameters.
2. TSP shall be obliged to provide/share all necessary documentations such as NBI Guide/MIB/IDL/WSDL/API files/ etc. for onward integration of their NMS/EMS/NE with regional UNMS.
3. The following support shall be provided by TSP for integration of their supplied equipment with regional UNMS:
 - Enabling and activating NBI license in their EMS/NMS and providing NBI login access along with User credentials
 - Assist in verifying NBI Connectivity with UNMS vendor for the successful communication and retrieval of data.
 - Assist in troubleshooting (if required) for NBI connectivity along with UNMS vendor for the communication and retrieval of data.
4. For standalone NE which is not integrated with any EMS/NMS, TSP shall provide modality of complete FCAPS data acquisition as above through industry standard programmatic methods and provide the CLI command manual.

Firewall Placement Diagram

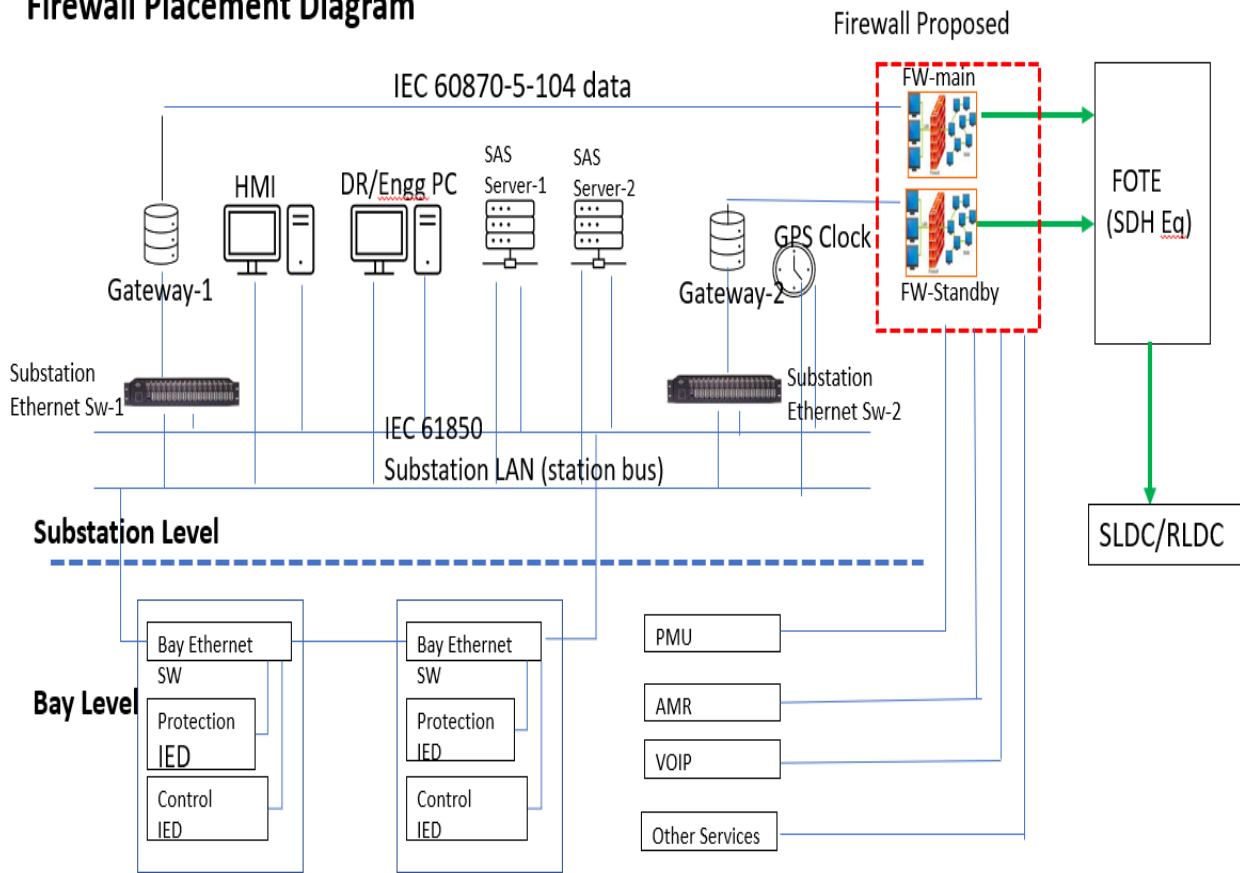

Figure F.2

D.10.0 PLCC and PABX:

Power line carrier communication (PLCC) equipment complete for speech, tele-protection commands and data channels shall be provided on each transmission line. The protections for transmission line and the line compensating equipment shall have hundred percent back up communication channels i.e. two channels for tele- protection in addition to one channel for speech plus data for each direction. The PLCC equipment shall in brief include the following: -

- Coupling device, Coupling filters, line traps, carrier terminals, protection couplers, HF cables, PABX (if applicable) and maintenance and testing instruments.
- At new substation, a telephone exchange (PABX) of 24 lines shall be provided at as means of effective communication among various buildings of the substation, remote end substations and with control centres (RLDC/ SLDC) etc.
- Coupling devices shall be suitable for phase-to-phase coupling for 765 kV Transmission lines. The pass band of coupling devices shall have sufficient margin for adding communication channel in future if required. Necessary protection devices for safety of personnel and low voltage part against power frequency voltages and transient over voltage shall also be provided.
- The line traps shall be broadband tuned suitable for blocking the complete range of carrier frequencies. Line Trap shall have necessary protective devices such as lightning arresters for the protection of tuning device. Decoupling network consisting of line traps and coupling capacitors may also be required at certain substation in case of extreme frequency congestion.
- The carrier terminals shall be of single sideband (SSB) amplitude modulation (AM) type and shall have 4 kHz band width. PLCC Carrier terminals and Protection couplers shall be considered for both ends of the line.
- PLCC equipment for all the transmission lines covered under the scheme (consisting of one set of analog PLCC channel along with circuit protection coupler and one set of Digital protection coupler for both ends) shall be provided by TSP. CVT and Wave trap for all the line bays under present scope shall be provided by TSP. PLCC to be provided for following lines under present scope:
- TSP shall provide new set of PLCC as per following configuration:

Sl. No.	Line Section	PLCC configuration
1.	Bikaner-IV PS – Siwani 765 kV	1 set Analog PLCC and 1 set Digital

Transmission Service Agreement

Sl. No.	Line Section	PLCC configuration
	D/C (2nd) line	Protection Coupler for each circuit at both ends.
2.	Siwani – Sonipat (PG) 400 kV D/C line	1 set Analog PLCC and 1 set Digital Protection Coupler for each circuit at both ends.
3.	Siwani – Jind (PG) 400 kV D/C line	1 set Analog PLCC and 1 set Digital Protection Coupler for each circuit at both ends.

All other associated equipment like cabling, coupling device and HF cable shall also be provided by the TSP.

Frequently Asked Queries:

1.0 Transmission Line:

1.1 Please clarify that whether shutdowns for crossing of existing transmission lines of POWERGRID/ STUs/ Power Evacuation Lines from Generation Plants/ Any other Transmission Licensee will be given to TSP on chargeable basis or free of cost.

Reply: Shutdowns for crossing of existing transmission lines of POWERGRID/ STUs/ Power Evacuation Lines from Generation Plants/ Any other Transmission Licensee will be given to TSP by the concerned owner of the lines as per their own terms and conditions.

1.2 We understand that the suggested swing angle criteria are applicable for Suspension Insulator in Suspension Tower. Further, you are requested to provide similar swing angle and clearance criteria for Pilot Insulator with Jumper and Jumper.

Reply: It is clarified that the swing angle criteria (as mentioned in RfP) for transmission lines is applicable for Suspension Insulator in Suspension Tower. Further, as per Clause 3.0 of Specific Technical Requirements for transmission lines, Transmission service Provider (TSP) shall adopt any additional loading/design criteria for ensuring reliability of the line, if so desired and /or deemed necessary.

1.3 We request you to kindly allow that use of diamond configuration at Power line crossings and the existing owner of the lines may be directed to allow the same for the successful bidders.

Reply: Power line crossing including diamond configuration is responsibility of the TSP. The TSP shall formally submit the profile of the crossing section to the owner of the existing line suggesting proposed crossing alternatives. The crossing will have to be carried out as per approval of owner of the existing line.

1.4 It is requested you to kindly provide present status of Forest Clearances if any transmission line corridor area falling in wildlife forest / reserve forest/ mangroves.

Reply: Based on the preliminary route survey, the process of initiation of forest clearance for the forest stretches, if any, enroute the proposed line alignment will be initiated by way of writing letters to the concerned authority (ies). However, it may be noted that it will be the responsibility of TSP for obtaining forest clearance for the forest stretches as provided in the survey report and also for any forest area encountered during detailed survey.

2.0 Substation

2.1 We understand that space for storage of O&M spare shall be provided by existing owner within the station boundary without any cost. Kindly confirm.

Reply: Space for storage of O&M spares shall be arranged by TSP on its own.

2.2 We presume that the O&M for the end Termination bays will be in the scope of the TSP and TSP shall not be liable for any payment towards O&M to the existing owner of the substation. Kindly confirm.

Reply: Operation and maintenance of the bays is solely responsibility of the TSP. TSP shall follow CEA's "Operation and Maintenance (O&M) guidelines and Standard Format for Memorandum of Understanding between New TSP and Existing TSP" issued by CEA vide its letter No. I/28514/2023 dated 22.06.2023. Copy of the guideline is available on CEA website at following link:

https://cea.nic.in/wp-content/uploads/pse_ttd/2023/06/om_guidelines.pdf

2.3 With reference to subject scheme of existing sub-station, we assumed following scope of work:

- (a) **We assumed internal road is available and need not to consider in the present scope of work.**
- (b) **Drainage is available and need not to consider in the present scope of work.**
- (c) **Cable trench extension in adjacent to Main cable trench only under present scope of work.**
- (d) **Levelled area being provided by developer for bay extension.**

Reply: Regarding requirement of internal road, drainage, cable trench, leveling of the bay extension area, bidder is advised to visit site and acquaint themselves with the provisions/facilities available at substation.

2.4 Kindly provide the soil investigation report of soil parameters of existing substation.

Reply: Bidder is advised to visit the substation site and ascertain the requisite parameters.

2.5 Kindly confirm, energy accounting of aux. power consumption. Whether it will be on chargeable basis or part of transmission loss.

Reply: It will be on chargeable basis.

2.6 We understand that VMS requirement is for unmanned stations only. For Manned stations VMS is not compulsory.

Reply: VMS shall be provided by TSP in line with requirements of RfP document.

2.7 It is understood that Construction water and power shall be provided free of cost to TSP by respective substation owner for construction of new bays.

Reply: Arrangement of construction power and water is in the scope of TSP.

2.8 It is understood that existing fire hydrant system shall be extended by the TSP for bay extension.

Reply: Existing fire hydrant system shall be extended from existing system (if required)

2.9 Please clarify that Status of land acquisition for Substations. Whether the lands have been acquired by BPC and will be transferred to TSP.

Reply: The acquisition of land for substation is in the scope of TSP.

2.10 We understood that no any dedicated metering CT and CVT required for Line/feeders. Further, we understood that requisite Energy meters for various 765 kV, 400 kV and 220 kV Feeders shall be provided and installed by CTU free of cost to TSP.

Reply: Dedicated metering CT and CVT are not required for line/feeders. Metering core of existing CT/CVT can be used provided accuracy class is matching with metering requirement. Requisite Special Energy Meters shall be provided and installed by CTU in C&P panel subject to space availability, else, in separate metering panel (to be provided by TSP at its cost).

3.0 Communication

3.1 What are the usage of OPGW, FOTE, PMU, etc. under communication requirement of RFP?

Reply: User shall be responsible for providing compatible equipment along with appropriate interface for uninterrupted communication with the concerned control center and shall be responsible for successful integration with the communication system provided by CTU.

Communication systems comprising OPGW, FOTE, PMU etc. are required for grid operation through RLDC/SLDC, speech communication, tele-protection and tele-metering.

3.2 Is space for installation of communication panels are provided to TSP in existing Substations incase new bays are in the scope of TSP?

Reply: The space related issues are deliberated in the RFP itself. TSP to carry out survey of the existing substation for physical space requirement. In case space is not available in the existing substation then TSP shall accommodate the same in the respective bay SPR (Switchyard Panel Room)/Bay Kiosk/ Relay panel room in case of GIS S/s. Further, TSP to connect and integrate the proposed FOTE with the existing FOTE in the control room.

In Case 132 kV Substation TSP shall accommodate the said panels either by extension of existing control room or other arrangements.

3.3 How is the OPGW laying done in case of LILO lines?

Reply: In case LILO lines are on same towers (e.g. both Line in and Line Out portion are on same towers, generally done LILO of S/C lines), then 2x24F OPGW shall be required to install by TSP on both earthwire peak on 400 kV and 765 kV lines where two E/W peaks are available. On 220 kV and 132 kV lines where only one E/W peak is available TSP to install one No. 48F OPGW.

Incase LILO lines are on different towers (e.g. both Line In and Line Out portion are on different towers, generally done LILO of D/C lines), then 1x24F OPGW shall be required to install by TSP on one earthwire peak, on both Line In and Line Out portions of 400 kV and 765 kV lines. On 220 kV and 132 kV lines where only one E/W peak is available TSP to install one No. 24F OPGW in place of conventional earthwire.

3.4 How is the OPGW laying done in case Multi circuit Towers?

Reply: In case two different lines are using common multi circuit portion for some distance (originating from different stations, may be terminating on same or on different stations), two No. 24F OPGW to be installed on both E/W peaks for common M/C portion of 765 kV and 400 kV lines.

In case 220/132 kV lines using multi circuit portion where single E/W peak is available one No. 48F may be installed for common multi circuit portion.

Schedule: 2**Scheduled COD**

[Note: As referred to in the definition of “Element”, “Scheduled COD”, and in Articles 3.1.3 (c), 4.1 (b) and 4.3 (a) of this Agreement]

Sl. No.	Name of the Transmission Element	Scheduled COD from effective date	Percentage of Quoted Transmission Charges recoverable on Scheduled COD of the Element of the Project	Element(s) which are pre-required for declaring the commercial operation (COD) of the respective Element.
1	Establishment of 765/400 kV, 6x1500 MVA S/s at suitable location near Siwani (Distt. Bhiwani) along with 2x240 MVA (765 kV) Bus Reactor and 2x125 MVA (420 kV) Bus Reactor	11/11/2026	100%	All elements of scheme are required to be commissioned simultaneously as their utilization is dependent on each other.
2	Bikaner-IV PS – Siwani 765 kV D/C (2 nd) line along with 240 MVA switchable line reactor for each circuit at each end			
3	STATCOM (2x±300MVA) along with MSC (4x125 MVA) and MSR (2x125 MVA) at Siwani S/s			
4	Siwani – Sonipat (PG) 400 kV D/C line (Quad) along with 63 MVA switchable line reactor for each circuit at Siwani S/s end			
5	Siwani – Jind (PG) 400 kV D/C line (Quad)			
6	2 Nos. 400 kV line bays each at Jind (PG) and Sonipat (PG) S/s			
7	2 Nos. 765 kV line bays at Bikaner-IV PS			

The payment of Transmission Charges for any Element, irrespective of its successful commissioning on or before its Scheduled COD, shall only be considered after successful commissioning of the Element(s), which are pre-required for declaring the commercial operation of such Element as mentioned in the above table.

Scheduled COD for the Project is: 24 months (11/11/2026)

[Note: List of Element(s) along with the critical Element(s) to be provided by CEA]

Schedule: 3

Safety Rules and Procedures

[Note: As referred to in Articles 5.6 of this Agreement]

1: Site Regulations and Safety:

The TSP shall establish Site regulations within sixty (60) days from fulfilment of conditions subsequent, as per Prudent Utility Practices setting out the rules to be observed till expiry of the Agreement at the Site and shall comply therewith.

Such Site regulations shall include, but shall not be limited to, rules in respect of security, safety of the Project, gate control, sanitation, medical care, and fire prevention, public health, environment protection, security of public life, etc.

Copies of such Site regulations shall be provided to the Nodal Agency and the CEA for the purpose of monitoring of the Project.

2: Emergency Work:

In cases of any emergency, the TSP shall carry out all necessary remedial work as may be necessary.

If the work done or caused to be done by any entity, other than the TSP, the TSP shall, reimburse the actual costs incurred, to the other Party carrying out such remedial works.

3: Site Clearance:

In the course of execution of the Agreement, the TSP shall keep the Site reasonably free from all unnecessary obstruction, storage, remove any surplus materials, clear away any wreckage, rubbish and temporary works from the Site, and remove any equipment no longer required for execution of the Agreement. After completion of all Elements of the Project, the TSP shall clear away and remove all wreckage, rubbish and debris of any kind from the Site, and shall leave the Site clean and safe.

4: Watching and Lighting:

The TSP shall provide and maintain at its own expense all lighting, fencing, and watching when and where necessary for the proper construction, operation, maintenance / repair of any of the Elements of the Project, or for the safety of the owners and occupiers of adjacent property and for the safety of the public, during such maintenance / repair.

Schedule: 4**Computation of Transmission Charges****1.1 General**

The Monthly Transmission Charges to be paid to the TSP for providing Transmission Service for any Contract Year during the term of the Agreement shall be computed in accordance with this Schedule and paid as per Sharing Regulations.

Illustration regarding payment of Transmission Charges under various scenarios (considering definitions of Contract Year, Expiry Date & Monthly Transmission Charges above) is as below: -

Illustration-1: In case the Project Elements achieve COD as per Schedule

Quoted Transmission Charges: **Rs. 140 Million**

Completion Schedule:

Element No.	Completion Schedule in Months	Scheduled CoD of the Element	Actual CoD of the Element	% Charges recoverable on Scheduled CoD of the Element
Element 1	28	1-Feb-2018	1-Feb-2018	25%
Element 2	38	1-Dec-2018	1-Dec-2018	75%

Tariff Payable as follows:

Transmission Charges for Element 1			Transmission Charges for Element 2		
1-Feb-18 to 31-Mar-18	140 X 25% X ((28+31)/365)	5.65		--	0.00
1-Apr-18 to 30-Nov-18	140 X 25% X (244/365)	23.39		--	0.00
1-Dec-18 to 31-Mar-19	140 X 100% X (121/365)				46.41
2	140 X 100% X 1				140
3	140 X 100% X 1				140
4	140 X 100% X 1				140
5	140 X 100% X 1				140
.....					
.....					
36 (1-Apr to 30-Nov)	140 X 100% X (244/365)				93.59

Illustration-2: In case of extension of Scheduled CoD as per Article 4.4.1 & 4.4.2 of this AgreementQuoted Transmission Charges: **Rs. 140 Million**

Completion Schedule:

Element No.	Completion Schedule in Months	Scheduled CoD of the Element	Actual CoD of the Element	% Charges recoverable on Scheduled CoD of the Element
Element 1	20	1-Feb-2018	1-Jul-2018	25%
Element 2	28	1-Oct-2018	1-Dec-2018	75%

Tariff Payable as follows:

Transmission Charges for Element 1			Transmission Charges for Element 2		
1-Feb-18 to 31-Mar-18	--	0.00		--	0.00
1-Apr-18 to 30-Jun-18	--	0.00		--	0.00
1-Jul-18 to 30-Nov-18	140 X 25% X (153/365)	14.67		--	0.00
1-Dec-18 to 31-Mar-19	140 X 100% X (121/365)				46.41
2	140 X 100% X 1				140
3	140 X 100% X 1				140
4	140 X 100% X 1				140
5	140 X 100% X 1				140
.....					
.....					
36 (1-Apr to 30-Nov)	140 X 100% X (244/365)				93.59

Illustration-3: In case of delay in achieving COD of Project & all individual Elements (COD of the Project achieved in Contract Year 1)

Quoted Transmission Charges: **Rs. 140 Million**

Completion Schedule:

Element No.	Completion Schedule in Months	Scheduled CoD of the Element	Actual CoD of the Element	% Charges recoverable on Scheduled CoD of the Element
Element 1	20	1-Feb-2018	1-Dec-2018	25%
Element 2	28	1-Oct-2018	1-Dec-2018	75%

Tariff Payable as follows:

Transmission Charges for Element 1			Transmission Charges for Element 2		
1-Feb-18 to 31-Mar-18	--	0.00		--	0.00
1-Apr-18 to 30-Sept-18	--	0.00		--	0.00
1-Oct-18 to 30-Nov-18	--	0.00	1-Oct-18 to 30-Nov-18	--	0.00
1-Dec-18 to 31-Mar-19	140 X 100% X (121/365)				46.41
2	140 X 100% X 1				140
3	140 X 100% X 1				140
4	140 X 100% X 1				140
5	140 X 100% X 1				140
.....					
.....					
36 (1-Apr to 30-Nov)	140 X 100% X (244/365)				93.59

Illustration-4: In case of delay in achieving COD of Project & all individual Elements (COD of the Project achieved in Contract Year other than Contract Year 1)Quoted Transmission Charges: **Rs. 140 Million**

Completion Schedule:

Element No.	Completion Schedule in Months	Scheduled CoD of the Element	Actual CoD of the Element	% Charges recoverable on Scheduled CoD of the Element
Element 1	38	1-Oct-2019	1-May-2020	25%
Element 2	38	1-Oct-2019	1-May-2020	75%

Tariff Payment to be paid as:

Transmission Charges for Element 1			Transmission Charges for Element 2		
1-Oct-19 to 31-Mar-20	--	0.00	1-Oct-19 to 31-Mar-20	--	0.00
1-Apr-20 to 30-Apr-20	-	0.00	1-Apr-20 to 30-Apr-20	-	0.00
1-May-20 to 31-Mar-21	140 X 100% X (335/365)				128.49
2	140 X 100% X 1				140
3	140 X 100% X 1				140
4	140 X 100% X 1				140
5	140 X 100% X 1				140
.....					
.....					
36 (1-Apr to 30-Apr)	140 X 100% X (30/ 365)				11.51

Illustration5: In case of delay in achieving COD of Element but Project COD achieved on timeQuoted Transmission Charges: **Rs. 140 Million**

Completion Schedule:

Element No.	Completion Schedule in Months	Scheduled CoD of the Element	Actual CoD of the Element	% Charges recoverable on Scheduled CoD of the Element
Element 1	20	1-Feb-2018	1-Jul-2018	25%
Element 2	30	1-Dec-2018	1-Dec-2018	75%

Tariff Payable as follows:

Transmission Charges for Element 1			Transmission Charges for Element 2		
1-Feb-18 to 31-Mar-18	--	0.00		--	0.00
1-Apr-18 to 30-Jun-18	--	0.00		--	0.00
1-Jul-18 to 30-Nov-18	140 X 25% X (153/365)	14.67		--	0.00
1-Dec-18 to 31-Mar-19	140 X 100% X (121/365)				46.41
2	140 X 100% X 1				140
3	140 X 100% X 1				140
4	140 X 100% X 1				140
5	140 X 100% X 1				140
.....					
.....					
36 (1-Apr to 30-Nov)	140 X 100% X (244/365)				93.59

Illustration-6: In case of early commissioning of ProjectQuoted Transmission Charges: **Rs. 140 Million**

Completion Schedule:

Element No.	Completion Schedule in Months	Scheduled CoD of the Element	Actual CoD of the Element	% Charges recoverable on Scheduled CoD of the Element
Element 1	38	1-Oct-2019	1-Jul-2019	25%
Element 2	38	1-Oct-2019	1-Jul-2019	75%

Tariff Payment to be paid as:

Transmission Charges for Element 1		Transmission Charges for Element 2	
1-July-19 to 31-Mar-20	140 X 100% X (274/365)		105.09
2	140 X 100% X 1		140
3	140 X 100% X 1		140
4	140 X 100% X 1		140
5	140 X 100% X 1		140
.....			
.....			
36 (1-Apr to 30-Jun)	140 X 100% X (91/365)		34.91

Illustration-7: In case of early commissioning of an elementQuoted Transmission Charges: **Rs. 140 Million**

Completion Schedule:

Element No.	Completion Schedule in Months	Scheduled CoD of the Element	Actual CoD of the Element	% Charges recoverable on Scheduled CoD of the Element
Element 1	38	1-Oct-2019	1-Apr-2019	25%
Element 2	38	1-Jul-2019	1-Jul-2019	75%

Tariff Payment to be paid as:

Transmission Charges for Element 1			Transmission Charges for Element 2		
1-Apr-2019 to 30-Jun-19	140 X 25% X (91/365)	8.72	1-Apr-2019 to 30-Jun-19	--	0.00
1-July-19 to 31-Mar-20	140 X 100% X (274/ 365)				105.09
2	140 X 100% X 1				140
3	140 X 100% X 1				140
4	140 X 100% X 1				140
5	140 X 100% X 1				140
.....					
.....					
36 (1-Apr-30-Jun)	140 X 100% X (91/365)				34.91

The Transmission Charges shall be payable on monthly basis as computed above.

1.2 Computation of Monthly Transmission Charges

The Monthly Transmission Charges for any month m in a Contract Year n shall be calculated as below:

For AC System:

- a. If Actual Transmission System Availability for the month m of contract year n is greater than or equal to 98% and less than or equal to 98.5%;

$$\text{Monthly Transmission Charges MTC}(m) = T_{mn} * 1$$

- a. If Actual Transmission System Availability for the month m of contract year n exceeds 98.5% and less than or equal to 99.75%;

$$\text{Monthly Transmission Charges MTC}(m) = T_{mn} * (\text{AA} / 98.5\%)$$

Transmission Service Agreement

- c. If Actual Transmission System Availability for the month m of contract year n is greater than 99.75%;

$$\text{Monthly Transmission Charges MTC}(m) = T_{mn} * (99.75\% / 98.5\%)$$

- d. If Actual Transmission System Availability for the month m of contract year n is less than 98% and greater than or equal to 95.00%;

$$\text{Monthly Transmission Charges MTC}(m) = T_{mn} * (AA / 98\%)$$

- e. If Actual Transmission System Availability for the month m of contract year falls below 95%;

$$\text{Monthly Transmission Charges MTC}(m) = T_{mn} * (AA / 98\%) - 0.02 * (T_{mn} * (AA / 95\%))$$

For DC System:

- a. If Actual Transmission System Availability for the month m of contract year n is greater than or equal to 95% and less than or equal to 96%;

$$\text{Monthly Transmission Charges MTC}(m) = T_{mn} * 1$$

- b. If Actual Transmission System Availability for the month m of contract year n exceeds 96% and less than or equal to 99.75%;

$$\text{Monthly Transmission Charges MTC}(m) = T_{mn} * (AA / 96\%)$$

- c. If Actual Transmission System Availability for the month m of contract year n is greater than 99.75%;

$$\text{Monthly Transmission Charges MTC}(m) = T_{mn} * (99.75\% / 96\%)$$

- d. If Actual Transmission System Availability for the month m of contract year n is less than 95% and greater than or equal to 92.00%;

$$\text{Monthly Transmission Charges MTC}(m) = T_{mn} * (AA / 95\%)$$

- e. If Actual Transmission System Availability for the month m of contract year falls below 92%;

$$\text{Monthly Transmission Charges MTC}(m) = T_{mn} * (AA / 95\%) - 0.02 * (T_{mn} * (AA / 92\%))$$

where:

- AA is the actual Availability, as certified by RPC, as per procedure provided in Schedule 6.
- m is the month in Contract Year 'n'

Transmission Service Agreement

- T_{mn} = Transmission Charges for the month 'm' in Contract Year 'n' =
(=Transmission Charge/ no. of days in the Year n)* no. of days in month m

Provided, no Transmission Charges shall be paid during the period for which the RLDC has not allowed the operation of the Element/Project due to the failure of the TSP to operate it as per the provisions of the Grid Code.

1.3 RLDC Fee & Charges

The payment of RLDC fee & charges, in accordance with relevant regulations of CERC, shall be the responsibility of the TSP.

Schedule: 5**Quoted Transmission Charges**

[Quoted Transmission Charges from Annexure - 21 of the RFP of the Selected Bidder to be inserted here]

[To be incorporated from the Bid of the Selected Bidder submitted during the e-reverse auction after its selection]

Quoted Transmission Charges: Rs. 5093.13 Million

.Proportionate Transmission Charges payable for each Element of the Project:

Sl. No.	Name of the Transmission Element	Percentage of Quoted Transmission Charges recoverable on Scheduled COD of the Element of the Project	Element(s) which are pre-required for declaring the commercial operation (COD) of the respective Element.
1	Establishment of 765/400 kV, 6x1500 MVA S/s at suitable location near Siwani (Distt. Bhiwani) along with 2x240 MVA (765 kV) Bus Reactor and 2x125 MVA (420 kV) Bus Reactor	100%	All elements of scheme are required to be commissioned simultaneously as their utilization is dependent on each other.
2	Bikaner-IV PS – Siwani 765 kV D/C (2 nd) line along with 240 MVA switchable line reactor for each circuit at each end		
3	STATCOM (2x±300MVA) along with MSC (4x125 MVA) and MSR (2x125 MVA) at Siwani S/s		
4	Siwani – Sonipat (PG) 400 kV D/C line (Quad) along with 63 MVA switchable line reactor for each circuit at Siwani S/s end		
5	Siwani – Jind (PG) 400 kV D/C line (Quad)		

Transmission Service Agreement

Sl. No.	Name of the Transmission Element	Percentage of Quoted Transmission Charges recoverable on Scheduled COD of the Element of the Project	Element(s) which are pre-required for declaring the commercial operation (COD) of the respective Element.
6	2 Nos. 400 kV line bays each at Jind (PG) and Sonipat (PG) S/s		
7	2 Nos. 765 kV line bays at Bikaner-IV PS		

Schedule: 6

Appendix IV of the Central Electricity Regulatory Commission (Terms and Conditions of Tariff) Regulations 2024

Procedure for Calculation of Transmission System Availability Factor for a Month

1. Transmission system availability factor for nth calendar month (“TAFPn”) shall be calculated by the respective transmission licensee, verified by the concerned Regional Load Dispatch Centre (RLDC) and certified by the Member-Secretary, Regional Power Committee of the region concerned, separately for each AC and HVDC transmission system and grouped according to sharing of transmission charges. In the case of the AC system, transmission System Availability shall be calculated separately for each Regional Transmission System and inter-regional transmission system. In the case of the HVDC system, transmission System Availability shall be calculated on a consolidated basis for all inter-state HVDC systems.
2. Transmission system availability factor for nth calendar month (“TAFPn”) shall be calculated by considering the following:
 - i) **AC transmission lines:** Each circuit of AC transmission line shall be considered as one element;
 - ii) **Inter-Connecting Transformers (ICTs):** Each ICT bank (three single-phase transformers together) shall form one element;
 - iii) **Static VAR Compensator (SVC):** SVC, along with SVC transformer, shall form one element;
 - iv) **Bus Reactors or Switchable line reactors:** Each Bus Reactors or Switchable line reactors shall be considered as one element;
 - v) **HVDC Bi-pole links:** Each pole of the HVDC link, along with associated equipment at both ends, shall be considered as one element;
 - vi) **HVDC back-to-back station:** Each block of the HVDC back-to-back station shall be considered as one element. If the associated AC line (necessary for the transfer of inter- regional power through the HVDC back-to-back station) is not available, the HVDC back-to-back station block shall also be considered unavailable;
 - vii) **Static Synchronous Compensation (“STATCOM”):** Each STATCOM shall be considered as a separate element.
3. The Availability of the AC and HVDC portion of the Transmission system shall be calculated by considering each category of transmission elements as under:

TAFPn (in %) for AC system:

$$= \frac{(o \times AV_o) + (p \times AV_p) + (q \times AV_q) + (r \times AV_r) + (u \times AV_u)}{(o + p + q + r + u)} \times 100$$

Where,

o	=	Total number of AC lines.
AV _o	=	Availability of o number of AC lines
p	=	Total number of bus reactors/switchable line reactors
AV _p	=	Availability of p number of bus reactors/switchable line reactors
q	=	Total number of ICTs
AV _q	=	Availability of q number of ICTs
r	=	Total number of SVCs
AV _r	=	Availability of r number of SVCs
u	=	Total number of STATCOM
AV _u	=	Availability of u number of STATCOM

TAFMn (in %) for HVDC System:

$$= \frac{\sum_{x=1}^s C_{xbp}(\text{act}) \times AV_{xbp} + \sum_{y=1}^t C_{ybtb}(\text{act}) \times AV_{ybtb}}{\sum_{x=1}^s C_{xbp} + \sum_{y=1}^t C_{ybtb}} \times 100$$

Where

C _{xbp} (act)	=	Total actual operated capacity of x th HVDC pole
C _{xbp}	=	Total rated capacity of x th HVDC pole
AV _{xbp}	=	Availability of x th HVDC pole
C _{ybtb} (act)	=	Total actual operated capacity of y th HVDC back-to-back station block
C _{ybtb}	=	Total rated capacity of y th HVDC back-to-back station block
AV _{ybtb}	=	Availability of y th HVDC back-to-back station block
s	=	Total no of HVDC poles
t	=	Total no of HVDC Back to Back blocks

4. The availability for each category of transmission elements shall be calculated based on the weightage factor, total hours under consideration and non-available hours for each element of that category. The formulae for calculation of the Availability of each category of the transmission elements are as per **Appendix-V**. The weightage factor for each category of transmission elements shall be considered asunder:
- (a) For each circuit of the AC line – The number of sub-conductors in the line multiplied by ckt-km;
 - (b) For each HVDC pole- The rated MW capacity x ckt-km;
 - (c) For each ICT bank – The rated MVA capacity;
 - (d) For SVC- The rated MVAR capacity (inductive and capacitive);
 - (e) For Bus Reactor/switchable line reactors – The rated MVAR capacity;
 - (f) For HVDC back-to-back stations connecting two Regional grids- Rated MW capacity of each block; and
 - (g) For STATCOM – Total rated MVAR Capacity
5. The transmission elements under outage due to the following reasons shall be deemed to be available:
- i. Shut down availed for maintenance of another transmission scheme or construction of new element or renovation/upgradation/additional capitalization in an existing system approved by the Commission. If the other transmission scheme belongs to the transmission licensee, the Member Secretary, RPC may restrict the deemed availability period to that considered reasonable by him for the work involved. In case of a dispute regarding deemed availability, the matter may be referred to the Chairperson, CEA, within 30 days.
 - ii. Switching off of a transmission line to restrict over-voltage and manual tripping of switched reactors as per the directions of the concerned RLDC.
 - iii. Shut down of a transmission line due to the Project(s) of NHAI, Railways and Border Road Organization, including for shifting or modification of such transmission line or any other infrastructure project approved by Ministry of Power. Member Secretary, RPC may restrict the deemed availability period to that considered reasonable by him for the work involved;

Provided that apart from the deemed availability, any other costs involved in the process of such shutdown of transmission line shall not be borne by the DICs.

Provided that such deemed availability shall be considered only for the period for which DICs are not affected by the shutdown of such transmission line.

6. For the following contingencies, the outage period of transmission elements, as certified by the Member Secretary, RPC, shall be excluded from the total time of the element under the period of consideration for the following contingencies:
 - i) Outage of elements due to force majeure events beyond the control of the transmission licensee. However, whether the same outage is due to force majeure (not design failure) will be verified by the Member Secretary, RPC. A reasonable restoration time for the element shall be considered by the Member Secretary, RPC, and any additional time taken by the transmission licensee for restoration of the element beyond the reasonable time shall be treated as outage time attributable to the transmission licensee. Member Secretary, RPC may consult the transmission licensee or any expert for estimation of reasonable restoration time. Circuits restored through ERS (Emergency Restoration System) shall be considered as available;
 - ii) Outage caused by grid incident/disturbance not attributable to the transmission licensee, e.g. faults in a substation or bays owned by another agency causing an outage of the transmission licensee's elements, and tripping of lines, ICTs, HVDC, etc., due to grid disturbance. However, if the element is not restored on receipt of direction from RLDC while normalizing the system following grid incident/disturbance within reasonable time, the element will be considered not available for the period of outage after issuance of RLDC's direction for restoration;
 - iii) The outage period which can be excluded for the purpose of sub-clause (i) and (ii) of this clause shall be declared as under:
 - a. Maximum up to one month by the Member Secretary, RPC;
 - b. Beyond one month and up to three months after the decision at RPC;
 - c. Beyond three months by the Commission for which the transmission license shall approach the Commission along with reasons and steps taken to mitigate the outage and restoration timeline.
7. Time frame for certification of transmission system availability: (1) The following schedule shall be followed for certification of availability by the Member Secretary of the concerned RPC:
 - Submission of outage data along with documentary proof (if any) and TAFPn calculation by Transmission Licensees to RLDC/ constituents
 - By the 5th of the following month;

Transmission Service Agreement

- Review of the outage data by RLDC / constituents and forward the same to respective RPC – by 20th of the month;
- Issue of availability certificate by respective RPC – by the 3rd of the next month.

Appendix-V

FORMULAE FOR CALCULATION OF AVAILABILITY OF EACH CATEGORY OF TRANSMISSION ELEMENTS

For AC transmission system

$$AV_o(\text{Availability of } o \text{ no. of AC lines}) = \frac{\sum_{i=1}^o W_i(T_i - TN_{Ai})/T_i}{\sum_{i=1}^o W_i}$$

$$AV_q(\text{Availability of } q \text{ no. of ICTs}) = \frac{\sum_{k=1}^q W_k(T_k - TN_{Ak})/T_k}{\sum_{k=1}^q W_k}$$

$$AV_r(\text{Availability of } r \text{ no. of SVCs}) = \frac{\sum_{l=1}^{r-1} W_l(T_l - TN_{Al})/T_l}{\sum_{l=1}^r W_l}$$

$$AV_p(\text{Availability of } p \text{ no. of Switched Bus reactors}) = \frac{\sum_{m=1}^p W_m(T_m - TN_{Am})/T_m}{\sum_{m=1}^p W_m}$$

$$AV_u(\text{Availability of } u \text{ no. of STATCOMs}) = \frac{\sum_{n=1}^u W_n(T_n - TN_{An})/T_n}{\sum_{n=1}^u W_n}$$

$$AV_{x_{bp}}(\text{Availability of an individual HVDC pole}) = \frac{(T_x - TN)}{T_x}$$

$AV_{y_{btb}}$ (Availability of an individual HVDC

$$\text{Back-to-back Blocks}) = \frac{(T_y - TN_{Ay})}{T_y}$$

For the HVDC transmission system

For the new HVDC commissioned but not completed twelve months;

For first 12 months: $[(AV_{xpb} \text{ or } AV_{ybtb}) \times 95\% / 85\%]$, subject to a ceiling of 95%.

Where,

o	=	Total number of AC lines;
AV_o	=	Availability of o number of AC lines;
p	=	Total number of bus reactors/switchable line reactors;
AV_p	=	Availability of p number of bus reactors/switchable line reactors;
q	=	Total number of ICTs;
AV_q	=	Availability of q number of ICTs;
r	=	Total number of SVCs;
AV_r	=	Availability of r number of SVCs;
U	=	Total number of STATCOM;
AV_u	=	Availability of u number of STATCOMs;
W_i	=	Weightage factor for i th transmission line;
W_k	=	Weightage factor for k th ICT;
W_l	=	Weightage factors for inductive & capacitive operation of l th SVC;
W_m	=	Weightage factor for m th bus reactor;
W_n	=	Weightage factor for n th STATCOM.
$T_i, T_k, T_l,$,	=	The total hours of i th AC line, k th ICT, l th SVC, m th Switched Bus Reactor
$T_m, T_n, T_x,$ T_y	=	& n th STATCOM, x th HVDC pole, y th HVDC back-to-back blocks during the period under consideration (excluding time period for outages not attributed to transmission licensee for the reasons given in Para 5 of the procedure)
T_{NAi}, T_{NAk}	=	The non-availability hours (excluding the time period for outages not T_{NAi}, T_{NAm} , attributable to transmission licensee taken as deemed availability as $T_{NAi}, T_{NAk}, T_{NAx}, T_{NAy}$ per Para 5 of the procedure) for i th AC line, k th ICT, l th SVC, m th Switched Bus Reactor, n th STATCOM, x th HVDC pole and y th HVDC back-to-back block.

Schedule: 7

Entire Bid (both financial bid and technical bid) of the Selected Bidder to be attached here

Bid dated 26.09.2024 shall be integral part of this agreement.

Schedule: 8

Contract Performance Guarantee

(To be on non-judicial stamp paper of appropriate value as per Stamp Act relevant to place of execution. Foreign entities submitting Bids are required to follow the applicable law in their country.)

In consideration of the[Insert name of the SPV or Selected Bidder on behalf of the TSP, or Lead Member in case of the Consortium, with address] agreeing to undertake the obligations under the Transmission Service Agreement datedand the other RFP Project Documents and the Nodal Agency and the[Insert the name of the BPC], agreeing to execute the *RFP Project Documents* with the Selected Bidder, regarding setting up the Project, the [Insert name and address of the bank issuing the guarantee and address of the head office] (hereinafter referred to as “Guarantor Bank”) hereby agrees unequivocally, irrevocably and unconditionally to pay to (being the Nodal Agency) _at[Insert the Place from the address of the Nodal Agency indicated in the TSA] forthwith on demand in writing from the Nodal Agency or any Officer authorized by it in this behalf, any amount up to and not exceeding Rupees Crores (Rs.) only [Insert the amount of the bank guarantee] on behalf of M/s. [Insert name of the Selected Bidder or SPV].

This guarantee shall be valid and binding on the Guarantor Bank up to and includingand shall not be terminable by notice or any change in the constitution of the Bank or the term of the Transmission Service Agreement or by any other reasons whatsoever and our liability hereunder shall not be impaired or discharged by any extension of time or variations or alternations made, given, or agreed with or without our knowledge or consent, by or between parties to the respective agreement.

Our liability under this Guarantee is restricted to Rs. Crores (Rs.) only. Our Guarantee shall remain in force until [Insert the date of validity of the Guarantee as per Article 3.1.2 of this Agreement]. The Nodal Agency, shall be entitled to invoke this Guarantee up to three hundred sixty five (365) days of the last date of the validity of this Guarantee.

The Guarantor Bank hereby expressly agrees that it shall not require any proof in addition to the written demand from (in its roles as the Nodal Agency), made in any format, raised at the above mentioned address of the Guarantor Bank, in order to make the said payment to Nodal Agency.

The Guarantor Bank shall make payment hereunder on first demand without restriction or conditions and notwithstanding any objection by [Insert name of the Selected Bidder], [Insert name of the TSP] and / or any other person. The Guarantor Bank shall not require Nodal Agency to justify the invocation of this BANK GUARANTEE, nor shall the Guarantor Bank have any recourse against Nodal Agency in respect of any payment made hereunder.

THIS BANK GUARANTEE shall be interpreted in accordance with the laws of India.

The Guarantor Bank represents that this BANK GUARANTEE has been established in such form and with such content that it is fully enforceable in accordance with its terms as against the Guarantor Bank in the manner provided herein.

THIS BANK GUARANTEE shall not be affected in any manner by reason of merger, amalgamation, restructuring, liquidation, winding up, dissolution or any other change in the constitution of the Guarantor Bank.

THIS BANK GUARANTEE shall be a primary obligation of the Guarantor Bank and accordingly Nodal Agency shall not be obliged before enforcing this BANK GUARANTEE to take any action in any court or arbitral proceedings against [Insert name of the SPV] or the Selected Bidder, as the case may be, to make any claim against or any demand on [Insert name of the SPV] or the Selected Bidder, as the case may be, or to give any notice to [Insert name of the SPV] or the Selected Bidder, as the case may be, or to enforce any security held by the Nodal Agency or to exercise, levy or enforce any distress, diligence or other process against [Insert name of the SPV] or the Selected Bidder, as the case may be.

The Guarantor Bank acknowledges that this BANK GUARANTEE is not personal to Nodal Agency and may be assigned, in whole or in part, (whether absolutely or by way of security) by Nodal Agency to any entity to whom the Nodal Agency is entitled to assign its rights and obligations under the Transmission Service Agreement.

The Guarantor Bank hereby agrees and acknowledges that Nodal Agency shall have a right to invoke this Bank Guarantee either in part or in full, as it may deem fit.

Transmission Service Agreement

Notwithstanding anything contained hereinabove, our liability under this Guarantee is restricted to Rs. Crores (Rs.) only and it shall remain in force until[Date to be inserted on the basis of Article 3.1.2 of the Transmission Service Agreement], with an additional claim period of three hundred sixty five (365) days thereafter. This BANK GUARANTEE shall be extended from time to time for such period, as may be desired by [Insert name of the Selected Bidder or Lead Member in case of the Consortium or SPV]. We are liable to pay the guaranteed amount or any part thereof under this Bank Guarantee only if Nodal Agency serves upon us a written claim or demand.

In witness where of:

Signature

Name:

Power of attorney No.:

For:

..... [Insert Name of the Bank]

Banker's Seal and Full Address, including mailing address of the Head Office

Schedule: 9

Methodology for determining the Relief Under Force Majeure Event & Change in Law during Construction Period

The relief in the form of revision in tariff due to Force Majeure Event leading to extension of Scheduled COD for a period beyond one hundred eighty (180) days and/ or Change in Law during the construction period shall be as under:

$$\Delta T = [(P \times d)] \div [1 - (1 + d)^{-n}]$$

Where,

ΔT = Change in Transmission Charges for each year

P = Sum of cumulative increase or decrease in the cost of the Project due to Change in Law and interest cost during construction corresponding to the period exceeding one hundred eighty (180) due to Force Majeure Event leading to extension of Scheduled COD for a period beyond one hundred eighty (180) days

n = number of years over which the Transmission Charges has to be paid

d = Discount rate as notified by the CERC, applicable on the Bid Deadline

The increase in Transmission Charges as stated above shall be applicable only if the value of increase in Transmission Charges as calculated above exceeds 0.30% (zero point three percent) of the quoted Transmission Charges of the TSP.

सेंट्रल ट्रान्समिशन यूटिलिटी ऑफ इंडिया लिमिटेड
CENTRAL TRANSMISSION UTILITY OF INDIA LIMITED
(Wholly Owned Subsidiary of Power Grid Corporation of India Limited)
(A Government of India Enterprise)

CONDITIONS OF CONTRACT

(Section - III: Conditions of Contracts)

for

Appointment of Independent Engineer for "Transmission system for evacuation of power from Rajasthan REZ Ph-IV (Part-3: 6GW) [Bikaner complex]: Part-B"

(Spec. No. CTUIL/IE/2024-25/58)

(This document is meant for exclusive purpose of bidding against this specification only and shall not be transferred, reproduced or otherwise used for purpose other than that for which it is specifically issued)

INTRODUCTION

This section (Section-III) of the RfP Documents provides the information necessary for bidders to prepare responsive bids, in accordance with the requirements of the Employer. It also provides information on bid submission and uploading the bid on GeM portal, on line bid opening, evaluation and on contract award. This section also provides all the rights and obligations of the parties under the Contract.

This Section (Section-III) contains provisions that are to be used unchanged unless Section-IV, which consists of provisions that supplement, amend, or specify in detail, information or requirements included in Section-III and that are specific to each procurement, states otherwise. If there is a conflict between the provisions of Section - III & Section - IV, the provisions of Section - IV shall prevail.

Bidders may note that the Employer has uploaded its 'Works & Procurement Policy and Procedure' (Vol.-I & II) along with its Updation/ Modification/Amendment thereof on POWERGRID's website.

A DEFINITION OF TERMS

Unless defined otherwise, the following terms wherever used in this document shall have the following meanings.

- I. 'Owner' or 'Employer' or 'Company' or 'CTUIL' or 'Client' shall mean the Central Transmission Utility of India Limited, Gurgaon, Haryana India (A Government of India Enterprise) and shall include their legal representatives, successors and permitted assigns.
- II. 'Engineer' or 'Engineer-in-Charge' or 'E.I.C.' shall mean the officer appointed in writing by the Employer, to act as 'Co-Ordinator' from time to time on behalf of the Employer. 'Engineer-in-Charge' shall mean the Engineer authorized by the Employer for inspection, scrutiny and approval of some or all of the services rendered by the Independent Engineer under the Contract.
- III. 'RfP Documents' shall mean the Request for Proposal (Section-I), Terms of Reference (ToR) for Independent Engineer (Section-II), this Conditions of Contract (Section-III), Special Conditions of Contract (Section-IV) and Proposal Form, Attachments & Schedules (Section-V), which subsequently forms a part of the contract along with such other documents as may be mutually agreed upon.
- IV. 'GeM Contract Order' shall mean the official order generated through GeM portal on behalf of the Employer notifying the Independent Engineer that his proposal has been accepted and that the Independent Engineer is required to execute the work/service as per Rfp documents/GeM contract Order.
- V. "Contract Documents" means the documents attached in GeM bid for subject tender and GeM Contract Order (including any amendments thereto).
- VI. "Effective Date" means the effective date/Service Start Date of GeM Contract Order from which the Time for Completion shall be determined.
- VII. A 'Week' shall mean a continuous period of seven (07) days.
- VIII. 'Indian Rupees' or the sign 'Rs.', INR, '₹', shall mean the currency of the Government of India.
- IX. The 'Government' shall mean the 'Government of India' or an authorized representative/agency/department of the 'Government of India'.
- X. The word imparting singular shall also include the plural and vice-versa where the context so requires.
- XI. 'Final Report'/Final Document' or 'Report' will mean with final report or 'document' prepared by the Independent Engineer as per Rfp documents/ Contract.

- XII. 'Month' shall mean calendar month, 'Day' or 'Days' unless herein otherwise expressly defined shall mean calendar day or day of 24 hours each.
- XIII. The title or heading shall not alter or affect the intent or scope of the clauses or articles of the documents.
- XIV. 'Person' shall include firms, companies, corporation and association or bodies of individuals, whether incorporated or not.
- XV. 'Independent Engineer' or 'Consultant' or "Contractor" shall mean the Firm/Agency/Bidder whose proposal has been accepted by the Employer for the Award of the work and shall include his legal representatives, successors and permitted assigns.
- XVI. 'Consultancy Assignment' or 'Work' or 'Study' or 'Assessment' or 'Services' shall mean the complete study/work as specified in the RfP Documents.
- XVII. VOID
- XVIII. Unless otherwise terminated under the provisions of any other relevant clause of the document, contract shall be deemed to have been completed after issuance of the certification from Engineer-in-Charge, that there is no demand outstanding against the Independent Engineer and all liabilities under the contract have been satisfactorily fulfilled by the Independent Engineer.
- XIX. "Contract Price" means the sum specified in the Contract/purchase order created / issued by the Buyer on GeM, subject to such additions or deductions therefrom, as may be made pursuant to the Contract. For the purpose of Contract Performance Guarantee, the "Contract Price" means the sum specified in the Contract/purchase order created / issued by the Buyer on GeM.
- XX. Key Managerial Personnel (KMP) of the company shall include CEO/Managing Director/ Company Secretary/ Director/ CFO/any of the partner in case of partnership firm/any other officer entrusted with substantial powers of the management of the affairs of the company/firm.
- XXI. Active contracts mean the contract shall be considered as active contract till the service end date as per the completion schedule mentioned in original contract or any other service end date in case of extension or foreclosure of contract.

1.0 SOURCE OF FUNDS

- 1.1 The Employer named in the Special Conditions of Contract (SCC) intends to use domestic funding for this work.

All eligible payments under the contract for the packages for which this Request for Proposal (RfP) is issued shall be made by the Employer named in the SCC.

2.0 ELIGIBLE BIDDERS

- 2.1 Central Transmission Utility of India Limited (CTUIL) will select Independent Engineer from amongst the eligible bidders who have submitted their proposals in response to Request for Proposal (RfP), which is placed in Section - I, in accordance with the method of selection specified in these Conditions of Contract.

- 2.2 This Request for Proposal (RfP), issued by the Employer, is open to all firms including company(ies), Government owned Enterprises registered and incorporated in India as per Companies Act, 1956 or 2013, barring foreign bidders/MNCs not registered and incorporated in India and those bidders with whom business is banned by the Employer.

Any Bidder from a country which shares a land border with India will be eligible to bid only if the Bidder is registered with the Competent Authority as per order no. F.No.6/18/2019-PPD (Order Public Procurement no.1) dated 23/07/2020 and F.No.6/18/2019-PPD (Order Public Procurement no.2) dated 23/07/2020, issued by Public Procurement Division, Department of Expenditure, Ministry of Finance, Government of India (DoE Order). Registration should be valid at the time of submission of proposals as per Clause 15.0 and at the time of GeM Contract order Generation.

However, the aforesaid condition for registration of Bidders from countries (even if sharing land border with India) shall not be applicable to Bidders from such countries to which Government of India has extended lines of credit or in which Government of India is engaged in development projects.

For the aforesaid purpose,

- (i) "Bidder" means any person or firm or company, including any member of a consortium or joint venture (that is an association of several persons, or firms or companies), every artificial juridical person not falling in any of the descriptions of Bidders stated hereinbefore, including any agency branch or office controlled by such person, participating in a procurement process.
- (ii) "Bidder from a country which shares a land border with India" for this purpose means:
 - a. An entity incorporated, established or registered in such a country; or
 - b. A subsidiary of an entity incorporated, established or registered in such a country; or
 - c. An entity substantially controlled through entities incorporated, established or registered in such a country; or
 - d. An entity whose beneficial owner is situated in such a country; or

- e. An Indian (or other) agent of such an entity; or
- f. A natural person who is a citizen of such a country; or
- g. A consortium or joint venture where any member of the consortium or joint venture falls under any of the above

(iii) The beneficial owner for the purpose of (ii) (d) above will be under:

1. In case of a company or Limited Liability Partnership, the beneficial owner is the natural person(s), who, whether acting alone or together, or through one or more juridical person, has controlling ownership interests or who exercises control through other means

Explanation-

- a. "Controlling ownership interest" means ownership of or entitlement to more than twenty-five percent of shares or capital or profits of the company
 - b. "Control" shall include the right to appoint majority of the directors or to control the management or policy decisions including by virtue of their shareholding or management rights or shareholders agreement or voting rights;
2. In case of a partnership firm, the beneficial owner is the natural person(s) who, whether acting alone or together, or through one or more juridical person, has ownership of entitlement to more than fifteen percent of capital or profits of the partnership;
 3. In case of an unincorporated association or body of individuals, the beneficial owner is the natural person(s), who, whether acting alone or together, or through one or more juridical person, has ownership of or entitlement to more than fifteen percent of the property or capital or profits of such association or body of individuals;
 4. Where no natural person is identified under (1) or (2) or (3) above, the beneficial owner is the relevant natural person who holds the position of senior managing official
 5. In case of a trust, the identification of beneficial owner(s) shall include identification of the author of the trust, the trustee, the beneficiaries with fifteen percent or more interest in the trust and any other natural person exercising ultimate effective control over the trust through a chain of control or ownership.

(iv) An Agent is a person employed to do any act for another, or to represent another in dealings with third person.

The Bidder shall in its bid submit a certificate in compliance to DoE order as per the given format.

2.3 Further, the Consultant / firm has to be a ‘**Class-I local supplier**’ as defined under Public Procurement (Preference to Make in India) Order, 2017 issued by Department for promotion of Industry and Internal Trade (DPIIT), Ministry of Commerce and Industry, Government of India vide order dated 15/06/2017, its revision dated 16/09/2020 (PPP-MII Order) read in conjunction with ‘Public Procurement (Preference to Make in India) to provide for Purchase Preference (linked with local content) in respect of Power Sector’ order dated 16/11/2021 issued by Ministry of Power (MoP Order) and subsequent modifications/amendments if any.

‘Local Content’ means the amount of value added in India which shall be the total value of the item procured (excluding net domestic indirect taxes) minus the value of imported content in the item (including all customs duties) as a proportion of the total value, in percent.

‘Class -I local supplier’ means a supplier or service provider, whose goods, services or works offered for procurement, has Local Content of minimum 60%.

Firms who are not ‘Class-I local supplier’ shall not be eligible to bid.

The ‘Class-I local supplier’ shall give a self-certification in his bid in the given format, indicating the percentage of Local Content and certifying that the item offered meets the Local Content requirement for ‘Class -I local supplier’ and shall give details of the location(s) at which value addition is made. Any false declaration regarding Local Content by the bidder shall be a transgression of RfP Documents and action shall be taken in line with provisions of the RfP Documents and in line with the provisions of the PPP-MII Order.

2.4 Consultants / Firms, who are executing contract(s) or has executed contract(s) in the past for the Employer and any of the following event(s) have been encountered during contract(s) execution, shall not be eligible to bid for the package(s) whose originally scheduled date of bid opening falls within the specified period reckoned from the date of determination by the Employer of such event as below:

Sr. No.	Event	Period for which proposal(s) / bid(s) shall be considered as non-responsive/ not eligible
1.	Termination of Contract due to Consultant’s / Contractor’s default	1 year
2.	Encashment of CPG due to non-performance	1 year
3.	Firm has been referred to NCLT under Insolvency & Bankruptcy Code (<i>IRP has been appointed or Liquidation proceedings have been initiated under IBC</i>)	Till the firm comes out of Resolution process

The Employer shall be the sole judge in this regard and the Employer's interpretation on the aforesaid event(s) shall be final and binding.

Notwithstanding the above, in case any of the event(s) as per Clause 2.4 is encountered afresh even prior to opening of Second Envelope/Price Part Bid of any package, the bid of such bidder shall be considered as non-responsive/not eligible for that package.

2.5 CONFLICT OF INTEREST

Bidder shall not have a conflict of interest that may affect the Selection Process or the Consultancy (the "Conflict of Interest"). Any bidder found to have a Conflict of Interest shall be disqualified. A bidder may be considered to have a conflict of interest with one or more parties in this bidding process, if:

- (a) they have a controlling partner in common; or
 - (b) they receive or have received any direct or indirect subsidy from any of them;
- or
- (c) they have the same legal representative for purposes of this Proposal; or
 - (d) they have a relationship with each other, directly or through common third parties, that puts them in a position to have access to information about or influence on the Proposal of another Bidder, or influence the decisions of the Employer regarding this bidding process.

The Consultant has an obligation to disclose to the Employer any situation of actual or potential conflict that impacts its capacity to serve the best interest of its Employer. Failure to disclose such situations may lead to the disqualification of the Consultant or the termination of its Contract.

Without limitation on the generality of the foregoing, the Consultant shall not be hired under the circumstances set forth below:

2.5.1 Conflicting Assignments

Conflict among consulting assignments: a Consultant (including its Experts) or any of its Affiliates shall not be hired for any assignment that, by its nature, may be in conflict with another assignment of the Consultant for the same or for another Employer.

2.5.3 Conflicting Relationships

Relationship with the Employer's staff: a Consultant (including its Experts) that has a close business or family relationship with a professional staff of the Employer who are directly or indirectly involved in any part of (i) the preparation of the Terms of Reference for the assignment, (ii) the selection process for the Contract, or (iii) the supervision of the Contract, may not be awarded a Contract, unless the conflict stemming from this relationship has been resolved in a manner acceptable to the Employer throughout the selection process and the execution of the Contract.

Relationship with Transmission Service Provider (TSP) and its staff: a Consultant (including its Experts) shall not have any affiliation with TSP and shall not have close business or family relationship with staff of TSP. -

2.6.0 The bidder shall not engage the same Project Manager, Transmission line Expert & Substation Expert in more than 4 (four) nos. of active contracts as on the original schedule date of bid opening. Bid shall be considered non-responsive, in case of use of any expert's CV beyond above said limit.

2.7.0 The bidder must ensure that proposed expert is not engaged/proposed by other bidder(s) for any IE packages of employer. In case of Non-compliance, their bids will be considered non-responsive.

2.8.0 Bidder must note that if the CV of any of the proposed experts are not submitted along with the bids, their bids will be considered non-responsive.

3.0 COST OF BIDDING DOCUMENT

Not Applicable.

4.0 CONTENT OF RfP DOCUMENT

The following documents constitute the RfP documents:

- a) Section – I : Request for Proposals;
- b) Section – II : Terms of Reference (ToR);
- c) Section – III : Conditions of Contract;
- d) Section – IV : Special Conditions of Contract;
- e) Section – V : Proposal Forms (Technical), Attachments & Schedules

4.1 This document is meant for the exclusive purpose of submitting the offer by the Consultant against the RfP Documents and shall not be transferred, reproduced or otherwise used for the purposes other than for which it is specifically issued.

5.0 CLARIFICATION OF RfP DOCUMENTS AND PRE-BID MEETING

5.1 The bidder is required to carefully examine the specifications and documents and fully inform himself as to all the conditions and matters which may in any way affect the works or the cost thereof. If any bidder finds discrepancies or omissions in the specifications and documents or is in doubt as to the true meaning of any part, he shall seek clarification from owner, in writing at the Employer's mailing address indicated at [Clause 14.0, Section-I: Request for Proposal](#), at once but in no case later than **Seven (07) days** prior to the deadline for submission of bids prescribed by the Owner. The Employer will respond through the portal <https://bidplus.gem.gov.in/all-bids#> to any request for clarification or modification of the Bidding Documents. The Employer shall not be obliged to respond to any request for clarification received later than the above period. After receipt of such interpretations and clarifications, the bidder may submit his offer but within the time and date as specified. All such interpretations and clarifications shall form an integral part of the specifications and documents and accompany the consultant's proposal. Further, the mere request for clarification from the Bidders shall not be a ground for seeking extension in the deadline for submission of bids. Employer's response (including an explanation of the query but not identification of its source) will be uploaded on portal <https://bidplus.gem.gov.in/all-bids#> where all the bidders can see clarification/reply to query.

Verbal clarifications and information given by the Employer or his Employee(s) or his representative(s) shall not in any way will be binding on the Employer.

Note: It is advisable for bidder to raise their queries preferably through GeM portal.

5.2 **Pre-Bid Meeting**

The Bidder's designated representative(s) is/are invited to attend a pre-bid meeting, which, if convened, will take place at the venue and time as indicated in Special Conditions Contract (SCC), Section-IV of RfP Document. The purpose of the meeting will be to clarify any issues regarding the e-procurement method, the Bidding Documents in general and the Terms of Reference (ToR)/Technical Specifications in particular. The Bidder is requested, as far as possible, to submit any question in writing, to reach the Employer not later than **two (02) days** before the meeting. It may not be practicable at the meeting to answer questions received late, but questions and responses will be transmitted as indicated hereafter. Minutes of the meeting, including the text of the questions raised (without identifying name of the bidders) and the responses given, together with any responses prepared after the meeting, will be transmitted without delay through the e-procurement portal only. Any modification of the Bidding Documents listed in **Clause 4.0 above**, which may become necessary as a result of the pre-bid meeting shall be made by the Employer exclusively through the issue of an Addendum pursuant to **Clause 6.0 below** and not through the minutes of the pre-bid meeting.

Non-attendance at the pre-bid meeting will not be a cause for disqualification of a bidder

6.0 **AMENDMENT OF RfP DOCUMENTS**

6.1 At any time prior to the deadline for the submission of Proposals, the Employer may, for any reason, whether at its own initiative or in response to clarification(s) requested by prospective Consultant(s), modify the RfP documents by amendment(s).

6.2 All prospective Bidders who have received the RfP documents will be notified of the amendments through GeM Portal itself.

6.3 In order to allow prospective Consultants reasonable time in which to take the amendments into account in preparing their Proposals, the Employer, may at its discretion, extend the deadline for the submission of Proposals.

7.0 **LANGUAGE OF BIDS**

The Proposal prepared by the Bidder and all correspondence and documents exchanged by the Bidder and the Employer related to the Proposal shall be written in the English language.

8.0 **DOCUMENTS COMPRISING THE PROPOSAL**

The Proposal should include a "Letter of First Envelope Proposal" along with its various Attachments/Forms (*First Envelope Proposal*) and "Second Envelope Proposal (Price Bid)" for commitments on behalf of the firm.

I. HARD COPY PART OF THE PROPOSAL:

Hard copy part of the proposal shall comprise of following documents to be submitted in sealed envelope as part of First Envelope:

- (i) Power of Attorney.
- (ii) Bid Security as per format provided in [Attachment-1](#) or documentary evidence in support of exemption of Bid Security.
- (iii) Bidders shall also submit Affidavit of Self certification regarding Minimum Local Content, if applicable, duly signed and stamped on each page, in line with PPP-MII Order as per the format provided in [Attachment-7](#).
- (iv) Integrity Pact
- (v) Any other document specified, duly signed and stamped on each page

Bidders shall note that no document is required to be submitted as part of Second envelope in Hard Copy.

II. SOFT COPY PART OF THE PROPOSAL:

Soft copy part of the Proposal shall comprise of following documents to be uploaded on the portal as per the provisions therein:

(a) As part of First Envelope

- (i) The Electronic Form/Template of the proposal for First Envelope, as available on the portal, shall be duly filled. (*if available*)
- (ii) Letter of First Envelope Proposal, duly completed and signed by the Bidder, together with the following attachments as given in RfP documents:
 - (a) Attachment 1 : Bid Security or documentary evidence in support of exemption of Bid Security (*submission of Hard copy in "Original" and uploading of Scanned Copy*).
 - (b) Attachment 2 : Bidder's Credentials towards Technical Evaluation Criteria (*uploading of Scanned Copy and Uploading of Scanned Copies of documentary evidence in support of Bidder's qualification*)

The documentary evidence of the Bidder's eligibility to bid shall establish to the Employer's satisfaction that the Bidder, at the time of submission of its bid, is eligible as defined in Clause 2.

The documentary evidence defining (i) the constitution or legal status; (ii) The principal place of business; (iii) The place of incorporation (for bidders who are corporations); or the place of registration and the nationality of the Owners (for applicants who are partnerships or individually-owned firms); (iv) In support of meeting the Technical experience, self-certified copy of Contract/ Award Letter and Utility Certificate.

The complete annual reports together with Audited statement of accounts of the company for last three years of its own (separate) immediately preceding the date of submission of bid. The Bidder shall also furnish documentary evidence/ declaration regarding Financial re-structuring of the company, if any.

Since the opening of the bids pursuant to [Clause 19.0](#) or the Technical Evaluation pursuant to [Clause 26.0](#) is carried out after 30th September, the bidder shall be required to submit the complete annual reports together with Audited statement of accounts of the company for the immediately preceding Financial Year except in cases where the Board of the Company/ Registrar of Companies has granted extension of time for finalization of accounts, for which the bidder has to submit requisite documentary evidence. In case of Bidder's failure to submit the same along with the Bid or subsequently pursuant to [Clause 20.0](#), the Bid shall be rejected.

- (c) Attachment 3 : Undertaking regarding unconditional acceptance of Provisions of RfP documents (*uploading of Scanned Copy*)
- (d) Attachment 4 : Information for E-payment, PF details and declaration regarding Micro/Small & Medium Enterprises (*uploading of Scanned Copy*)
- (e) Attachment 5 : Power of Attorney (*submission of Hard copy in "Original" and uploading of Scanned Copy*)

A power of attorney, duly notarized, indicating that the person(s) signing the Proposal has(ve) the authority to sign the Proposal and thus the Proposal is binding upon the Bidder during full period of its validity, in accordance with [Clause 12.0](#) below.

Further, Bidder shall furnish copy of partnership deed, in case of partnership firm, Memorandum and Articles of Association, in case of limited company, ownership

certificate in case of sole or proprietorship firm. *(if applicable)*

Bidder shall furnish this PoA in its own format.

- (f) Attachment 6 : Certification by the Bidder as per DoE Order in line with Clause 2.2 *(uploading of Scanned Copy)*
- (g) Attachment 7 : Affidavit of Self certification regarding Minimum Local Content in line with PPP-MII order *(submission of Hard Copy in 'Original')*, to be submitted on a non-judicial stamp paper of Rs. 100/-.

In line with the PPP-MII order, the bidder shall submit the Affidavit of self-certification, in original, indicating the percentage of Local Content and certifying that the item offered meets the Minimum Local Content and shall give details of the location(s) at which value addition is made, as prescribed in the PPP-MII Order, on a non-judicial stamp paper of Rs. 100/-.

Further, Self-certification submitted by the bidder may be verified randomly by the committee constituted as per PPP-MII order. In case of false documents/ misrepresentation of the facts, requisite action against such bidder will be taken based on the recommendation of the committee and in line with provisions of the Integrity pact.

Bidder may note that the other directions of Nodal Ministry as identified under PPP-MII order shall also be suitably considered in regard to verification/ action of the certificate

- (h) Attachment 8 : Declaration by the Bidder regarding events encountered pursuant to Clause 2.4 *(uploading of Scanned Copy)*
- (i) Attachment 9 : Integrity Pact *(submission of Hard copy in "Original" and uploading of Scanned Copy)*

The Bidder shall complete the accompanying Integrity Pact, which shall be applicable for bidding as well as contract execution, duly signed on each page by the person signing the bid and shall be returned by the Bidder in two (2) originals alongwith the Techno - Commercial Part in a separate envelope, duly superscripted with 'Integrity Pact'. The Bidder shall submit the Integrity Pact on a non-judicial stamp

paper of Rs. 100/-.

(j) Attachment 10 : KMP Declaration (*uploading of Scanned Copy*)

(k) Attachment 11 : Information regarding Ex-employees of CTUIL/
POWERGRID in our Organization (*uploading of
Scanned Copy*)

The complete information sought above with any additional information considered necessary by the Bidder as a part of the Proposal, should be submitted.

(iii) Scanned copies of all the documents mentioned at [Clause 8.0 \(I\)](#) above.

(iv) Scanned copies of any other documents which Consultant consider relevant along with First Envelope.

(v) **Uploading Price Bid in any form with first envelope proposal will be at the Bidder's risk and may result in rejection of its proposal.**

(b) As part of Second Envelope

(i) Price bid shall be fill/uploaded on GeM portal only as per GeM guidelines.

(ii) The Bidders shall upload the break-up of Price Schedule/Price bid on GeM portal as per GeM guidelines/procedure along with applicable GST (it should not be the part of 1st Envelope/Tech bid). Format for Price breakup is available with the RfP documents.

Submission of Soft Copy of any documents by any other means shall not be accepted by the Employer in any circumstances.

9.0 PROPOSAL PRICE

9.1 The Bidder shall quote their Proposal Price (in Indian Rupees) on GeM Portal for the scope of work as specified in the Section-II: TOR of RfP Documents as per Clause 8.0 II (b) (i) above and price breakup of the proposal price in format available in RfP Document as per Clause 8.0 II (b) (ii) above. Further, such Proposal Price of the Consultant covers all the Consultants' obligations mentioned in or to be reasonably inferred from the RfP Documents to successfully execute the intended services, on a "**single responsibility**" basis.

9.2 The Proposal Prices quoted by the Bidder shall be **fixed** during the performance of the contract and not subject to variation on any account. A Proposal submitted with an adjustable price quotation will be treated as nonresponsive and rejected.

9.3 The Proposal Prices quoted by the Bidder shall be inclusive of all charges, incl applicable GST. Taxes should be indicated separately while raising the bills for payment of the Charges. The Employer will not have any additional financial liability. Employer shall, however, be making deductions, at source as per relevant Laws/ other applicable laws in India, if any.

9.4 VOID

- 9.5 The Employer does not bind itself to accept the lower or any offer or to give any reasons for its decision. The participating Consultants may note that the decision of Employer shall be final and binding on all matters/issues arising out the bidding process.
- 9.6 The Bidder shall furnish the details of Bank Account in the prescribed format along with Bid in order to facilitate the Employer to release payments electronically through Electronic Fund transfer System, wherever technically feasible.
- 9.7 Quoted unit rate shall be rounded off to two decimals places (*if required*) for evaluation/payment purpose.

10.0 PROPOSAL CURRENCIES

The Bidder is required to quote charges in Indian Rupees (INR) and shall remain FIRM during the course of the contract. The charges quoted by the bidder should be inclusive of all charges incl applicable GST, which shall be as applicable. Taxes should be indicated separately while raising the bills for payment of charges. Withholding taxes, as applicable, will be deducted at the time of making payment. All payments shall be made in the currency of Proposal.

11.0 PROPOSAL SECURITY

- 11.1 The Bidder shall furnish, except as exempted herein below, as part of its bid, a proposal security for an amount specified in Special Conditions of Contract (SCC), Section-IV of RfP Document. The proposal security must be submitted in the form provided in the RfP Documents (*Proforma at Attachment-1, Section-IV of RfP documents*).
- 11.2 Bidders who fall under the categories mentioned at cl. 4 (xiii)(m) [(i)to(viii)] of General Terms and Conditions on GeM 4.0 (Version 1.18) dated 06.09.2024 and its subsequent amendment thereof, shall be exempted from submission of proposal security.
- 11.3 The proposal security shall, at the bidder's option, be in the form of a crossed bank draft/pay order /banker certified cheque in favour of Employer i.e. 'Central Transmission Utility of India Limited' payable at Gurgaon or a bank guarantee, which should be issued either:
- (a) by a Public Sector Bank located in India, or
 - (b) a scheduled Indian Bank having paid up capital (net of any accumulated losses) of Rs. 1,000 Million or above (the latest annual report of the Bank should support compliance of capital adequacy ratio requirement), or
 - (c) by a foreign bank or a subsidiary of a foreign bank, acceptable to the Employer, with overall international corporate rating or rating of long-term debt not less than A- (A minus) or equivalent by a reputed rating agency. Further, the Bank Guarantee should be confirmed by either (i) its corresponding bank located in India; or (ii) a Public Sector

Bank located in India; or (iii) a scheduled commercial private bank located in India as per para (b) above.

The format of the bank guarantee shall be in accordance with the form of proposal security included in the RfP Documents. proposal Security shall be valid upto date specified in Special Conditions of Contract (SCC), Section-IV of RfP Document, or any other date as subsequently requested under [Clause 12.2](#) below.

Alternatively, Proposal security can be submitted as online payment through National Electric Funds Transfer (NEFT)/Real-time gross settlement (RTGS). Details of Bank Account for transfer of tender through NEFT/RTGS are as follows:

Beneficiary Name : Central Transmission Utility of India Ltd
Bank Name : ICICI Bank
Branch Address : Plot No. 2, Sec-29, Gurgaon, Haryana
Account No. : 057205000382
IFSC Code : ICIC0000572

The copy of 'Online Payment Acknowledgement' generated subsequent to the payment shall be submitted along with hard copy part of the bid.

- 11.4 In case, pursuant to Ministry of Finance, GOI's Circular dated 17th July, 2012, the Bank Guarantee is issued using SFMS Platform by the banks located in India, the copy of such Bank Guarantee shall be submitted by the bidder along with the First Envelope.

At the time of issuance of the BG (including its extensions), in order to avail BG verification through SFMS facility, the issuing Bank will input the IFSC code as SBIN0017313 which is the bank of the beneficiary i.e. Central Transmission Utility of India Limited (CTUIL), in the Advising Bank field in their Trade Finance Portal for BG issue. The Account details of CTUIL for the purpose of Bank Guarantee (towards Bid Security) to be issued using SFMS Platform are as given below:

- Account No. : 40007029694
- IFSC Code : SBIN0017313
- Branch : CAG-II New Delhi (17313)

Following additional paragraph regarding issuance of Bank Guarantee through SFMS Platform consisting of the following should be added at the end of the proforma of the Bank Guarantee (i.e. end paragraph of the Bank Guarantee preceding the signatures of the issuing authority of the BG)

"This Guarantee has been issued using SFMS Platform and the requisite communication in this regard has been forwarded to the Beneficiary Bank."

In addition to the above, the Bank Guarantee (towards Proposal Security) should be submitted in the Physical form as specified in [Clause 11.1](#) above.

- 11.5 Any proposal not accompanied by an acceptable proposal security or Online Payment Acknowledgement towards Proposal Security, except as exempted at [Clause 11.2](#) above, shall be rejected by the Employer as being nonresponsive.

- 11.6 The proposal securities of unsuccessful bidders will be returned as promptly as possible, but not later than twenty-eight (28) days after the expiration of the proposal validity period.
- 11.7 The successful Bidder shall be required to keep its proposal security valid for a sufficient period till the performance security(ies) pursuant to [Clause 37.0 of Section-III \(Conditions of Contract\)](#) are furnished to the satisfaction of the Employer. The proposal security of the successful Bidder will be returned when the Bidder will get the GeM Contract Order, and has furnished the required performance security, pursuant to [Clause 37.0 of Section-III \(Conditions of Contract\)](#).
- 11.8 The proposal security may be forfeited
- (a) if the Bidder withdraws its proposal during the period of proposal validity specified by the Bidder in the Bid Form; or
 - (b) In case the Bidder does not withdraw the deviations proposed by him, if any, at the cost of withdrawal stated by him in the bid; or
 - (c) If a Bidder does not accept the corrections to arithmetical errors identified during preliminary evaluation of his proposal pursuant to [Clause 31.0 of Section-III, Conditions of Contract](#); or
 - (d) in the case of a successful Bidder, if the Bidder fails within the specified time limit:
 - (i) to accept GeM Contract Order, or
 - (ii) to furnish the required performance security(ies), in accordance with [Clause 37.0 of Section-III \(Conditions of Contract\)](#) and/or to keep the proposal security valid as per the requirement of [Clause 11.3 of Section-III \(Conditions of Contract\)](#).
- 11.9 No interest shall be payable by the Employer on the above Proposal Security.

12.0 PERIOD OF VALIDITY OF PROPOSAL

- 12.1 Proposals shall remain valid for the period of **180 (One Hundred and Eighty) days** from the bid submission end date, prescribed by the Employer, pursuant to [Clause 15.0](#) given below. A Proposal valid for a shorter period shall be rejected by the Employer as being non-responsive.
- 12.2 In exceptional circumstance, the Employer may solicit the Bidder's consent to an extension of the Proposal validity period. The request and responses thereto shall be made in writing or by cable. If a Bidder accepts to prolong the period of validity, the validity of proposal security shall also be suitably extended. A Bidder may refuse the request without forfeiting its proposal security. A Bidder granting the request will not be required or permitted to modify its proposal.

13.0 SIGNING AND FORMAT OF PROPOSAL

- 13.1 The proposal must contain the name, designation, residence and place of business of the person or persons making the offer and must be duly signed and stamped on each page by the Consultant with his usual signature.
- 13.2 Proposals by corporation/company must be signed with the legal name of the corporation/company by the President, Managing Director or by the Secretary or other person or persons authorized to furnish proposal on behalf of such corporation/company in the matter.
- 13.3 The power of attorney in the name of the person signing on behalf of the Consultant shall be furnished along with the proposal.
- 13.4 The Bidder's name stated on the proposal shall be the exact legal name of the firm.
- 13.5 Erasures or other changes in the proposal shall be authenticated by the initials of the persons signing the Proposal.

14.0 SEALING AND MARKING OF PROPOSALS

As per [Clause 8.0](#) above, the Bidders shall upload the soft copy of the proposal as per the provisions of the Portal and submit the hard copy of Power of Attorney, Bid Security, Affidavit of Self certification regarding Minimum Local Content under PPP-MII order, if applicable and Integrity Pact duly marked as hard copy part of First Envelope Proposal in the following manner:

Envelope-1: Proposal Security/ documentary evidence in support of exemption of Proposal Security

Envelope-2: Power of Attorney and any other documents as required, Affidavit of Self certification regarding Minimum Local Content under PPP-MII order, if applicable, Integrity Pact

15.0 SUBMISSION OF PROPOSALS

The envelope shall

- (a) be addressed to the Employer at the address given below; and
- (b) bear the package name/title and number indicated in the 'Request for Proposal', and the statement "**Do Not Open Before [date]**," to be completed with the time and date as specified below:

Address for submission of Hard copy of Documents;

Address in Person or by Post:

Central Transmission Utility of India Limited
(A wholly owned subsidiary of POWERGRID)
10th floor, IRCON International Tower-1, Plot No. 16
Sector-32, Gurugram - 122001, Haryana

Kind Attention: Mr. Dwaipayan Sen (Manager, C&M-CTUIL)/ Mr. Rahul (Manager,
C&M-CTUIL)

Mobile: +91- 9205287422/9205472328

Deadline for submission of Soft copy part of Proposal is:

As provided in Special Condition of Contract (SCC), Section-IV of RfP Documents

Deadline for submission of Hard copy part of Proposal:

As provided in Special Condition of Contract (SCC), Section-IV of RfP Documents

Proposal submission timelines will be defined as per the e-Procurement/GeM server clock only.

Bidders may submit any other documents which they consider relevant along with First Envelope.

All the envelopes shall also indicate the name and address of the Bidders so that the proposal can be returned unopened in case it is declared "late."

15.1 If the envelope is not sealed and marked as required by [Clause 14.0](#) above, the Employer will assume no responsibility for the Proposal's misplacement or premature opening.

16.0 DEADLINE FOR SUBMISSION OF PROPOSAL:

16.1 Soft copy of the proposal shall be uploaded through the Portal at or before the submission time and date as stipulated in Section-IV of the RfP document. Hard copy of documents stipulated at [Clause 8.0 \(I\) above](#), must be received by the Employer at the address specified no later than the time and date stated in [Clause 15.0](#) above. In the event of the specified date for the submission of proposals being declared a holiday for the Employer, the proposals will be received/uploaded upto the appointed time on the next working day.

16.2 The Employer may, at its discretion, extend this deadline for submission of proposals by amending the RfP Documents in accordance with [Sub-Clause 6.1 above](#) for the reasons specified therein at any time prior to opening of proposals by the Employer pursuant to [Sub-Clause 6.3 above](#), in which case all rights and obligations of Employer and consultants will thereafter be subject to the deadline as extended.

Further the Employer also reserves the right to extend Proposal submission timeline or recall the tender if Portal's server is down (i.e. inaccessible / inoperative) for a prolonged period of time within the last 24 hours of the Proposal submission due date.

17.0 LATE PROPOSALS

The Bidder shall not be permitted to submit the soft copy part of the Proposal by any mode other than uploading on the Portal within the specified deadline for submission of Proposals. The e-Procurement system would not allow any late submission of Proposals through the Portal after due date & time as specified under [Clause 15.0 above](#).

In case Hard copy part of the Proposal is received by the Employer after the deadline for submission of the same prescribed by the Employer in the [Clause 15.0 above](#), but the Bidders has uploaded the soft copy part of the Proposal, the Proposal will be considered as late Proposal. In such a case, the soft copy part of the first envelope Proposal uploaded on the Portal shall be opened. Such Proposals will be rejected during preliminary examination.

18.0 MODIFICATION AND WITHDRAWAL OF PROPOSALS

18.1 Bidder may modify its Proposals through the relevant provisions on the GeM Portal. The Bidder may modify or withdraw its Proposal after submission, provided that modification is done on the portal as well as notice is received by the Employer prior to the deadline prescribed for Proposal submission.

18.2 The Bidder's modifications shall be done and submitted as follows:

(i) Modified Electronic form/Template of the Proposal as per the provision of portal therein.

(ii) Soft copy of the entire Proposal if any modification is there.

18.3 Bidder may withdraw its Proposal through the relevant provisions of portal only.

18.4 No Proposal may be withdrawn in the interval between the Proposal submission deadline and the expiration of the Proposal validity period. Withdrawal of a Proposal during this interval may result in the forfeiture of Bidder's Proposal security, pursuant to [Sub-Clause 11.7 above](#).

19.0 OPENING OF FIRST ENVELOPE PROPOSAL BY EMPLOYER

19.1 The Employer will open the First Envelope Proposal in public as per GeM procedure, including withdrawals and modifications made pursuant to [Clause 18.0 above](#), in the presence of consultants' designated representatives who choose to attend, at the time, date, and location stipulated below. The consultants' representatives who are present shall sign a register evidencing their attendance. Consultants who have submitted their Proposal may view on line Proposal opening on the portal from their end. In the event of

the specified date for the submission of Proposals being declared a holiday for the Employer, the Proposals will be received upto the appointed time on the next working day.

Time and date for Proposal Opening – First Envelope:

As provided in Special Condition of Contract (SCC), Section-IV of RfP Documents

Address for Proposal Opening:

CENTRAL TRANSMISSION UTILITY OF INDIA LIMITED.

(A wholly owned subsidiary of POWERGRID)

10th floor, IRCON International Tower-1, Plot No. 16

Sector-32, Gurugram - 122001, Haryana

- 19.2 During the opening of Proposals, Envelopes marked “Withdrawal” shall be opened first. Proposals withdrawn pursuant to [Clause 18.0 above](#) shall not be opened. Softcopy of such Proposal shall be sent to archive unopened.
- 19.3 For all other Proposals, the consultants’ names, and any such other details as the Employer may consider appropriate, will be get declared through the Portal by the Employer. Subsequently, all envelopes marked “Modification” shall be opened. No Proposal shall be rejected at Proposal opening. However, opening of Proposal, whether or not accompanied with the undertaking etc., shall not be construed to imply its acceptability which shall be examined in detail pursuant to the provisions contained in this Section-III.
- 19.4 The Employer shall prepare minutes of the Proposal opening in the form of Bid Opening Statement, including the information disclosed to those present in accordance with [Sub-Clause 19.3 above](#).
- 19.5 Proposals not opened at Proposal opening shall not be considered further for evaluation, irrespective of the circumstances and shall be returned to the Consultant unopened/send to archive unopened.

Note : The offers of such Consultants who have withdrawn their offers, who have not submitted Proposal Security, whose offers are not responsive as per the provisions of the RFP Documents will be rejected during evaluation of 1st Envelope Proposals. The financial Proposal (Second Envelope) of such Consultant(s) will not be opened and shall be sent to archive unopened.

20.0 CLARIFICATION OF PROPOSALS

During proposal evaluation, the Owner may, at its discretion, ask the Consultant for a clarification of its proposal. In case of erroneous/non-submission of documents related to/identified in [Sub-Clause 8.0\(II\)\(a\)\(ii\) - \(b\), \(c\), \(d\), \(e\), \(f\), \(g\), \(h\), \(i\) & \(j\)](#) and complete annual reports of Last three financial years together with Audited statement of accounts, Online Payment acknowledgment towards Bid Security (in

cases where online payment has been made prior to the deadline for submission of hardcopy part of the bids), documentary evidence with regard to registration with designated Authority of GoI under the Public Procurement Policy for MSEs required to be submitted by the Consultant as per the provisions of the RfP Documents, the Employer may give the Consultant not more than 07(Seven) **days'** notice to rectify/furnish such documents, failing which the Proposal shall be rejected. The request for clarification and the response shall be in writing, and no change in the price and CVs or substance of the Proposal shall be sought, offered or permitted.

In case of non-submission of documents related to/identified in Attachment-11 {'Information regarding ex-employees of Employer in Bidder's firm'}, the Employer may give the Bidder not more than 7 days' notice to rectify/furnish such documents, failing which Employer reserves the right to reject such bids. Employer shall be sole judge in this regard.

21.0 OPENING OF FINANCIAL PROPOSALS (SECOND ENVELOPE) BY EMPLOYER:

21.1 The Second Envelope i.e., Price Part of only those Bidders shall be opened who are determined as having submitted substantially responsive First Envelope Proposals as a result of First Envelope evaluation as per **Clause 25.0 and 26.0 below**. Such Bidders shall get intimated through GeM portal about the date and time for opening of Price Part i.e., Second Envelope of the Proposals by the Employer. A negative determination of the proposal pursuant to **Clause 25.0 and 26.0 below**, shall be notified by the Employer to such Consultants and the Second Envelope submitted by them shall be sent to archive unopened and the Proposal Security shall be returned.

21.2 The Employer will open Second Envelope i.e., Price Part at the specified time and date in the presence of bidder's designated representatives who choose to attend, at the time, date, and location stipulated in the intimation for opening of Second Envelope. The Consultants' representatives who are present shall sign a register/paper evidencing their attendance. Consultants who have submitted their proposal and found qualified as mentioned at **Sub-Clause 21.1 above** may view online tender opening on the GeM portal from their end.

21.3 The Bidders' names, the Proposal Prices, or any discounts, and any such other details as per Electronic form filled in by the Consultant on the portal will become viewable at the time of opening of Proposals as per GeM guidelines. The prices and details as filled up in Electronic Form/Template by the bidder and opened during the Proposal opening and recorded in the Bid Opening Statement would not be construed to determine the relative ranking amongst the Bidders, or the successful Bidder, and would not confer any right or claim whatsoever on any Bidder.

21.4 The Employer shall get bid opening statement of the proposal opening, including the information disclosed to those present in accordance with **Sub-Clause 21.3 above**.

24.5 Proposals not opened and read out at Proposal opening shall not be considered further for evaluation, irrespective of the circumstances.

25.0 QUALIFICATION CRITERIA

The Bidder(s) meeting the minimum qualification criteria specified at **Annexure-I to Section-III** and whose proposals are eligible in line with the [Clause 2.0 above](#) will be short-listed for technical evaluation through **Quality and Cost Based Selection (QCBS)** methodology. The criteria for Technical Evaluation through QCBS methodology are given at [Clause 26.0](#) below.

Bidder(s) should clearly indicate, giving explicit supporting documentary evidence, with respect to the above, in absence of which their proposals will be rejected summarily at the pre-qualification stage itself and shall not be considered for further evaluation.

25.1 The following requirements shall strictly be complied by the Bidders.

1. Proposals taking any exception to scope of work and any conditions specified in the RfP documents shall be liable for rejection.
2. Proposals should be submitted strictly as per the prescribed format/GeM format. Proposals not in the prescribed format are liable for rejection.

26.0 EVALUATION OF TECHNICAL PROPOSALS THROUGH QCBS METHODOLOGY

26.1 Only those Bidders who meet the minimum Qualification Criteria specified in [Clause 25.0 above](#) shall qualify for evaluation through QCBS method. Proposals of firms who do not meet these criteria shall be rejected.

26.2 The scoring criteria to be used in the detailed technical evaluation are attached as *Annexure-I to Section-III*.

27.0 SHORTLISTING OF BIDDERS IN TECHNICAL EVALUATION

27.1 The Technical Proposal will be evaluated as per [Sub-Clause 26.2 above](#). Only those bidders whose Technical Score is 70 (Seventy) marks or more out of 100 (One Hundred) shall be shortlisted for opening of financial proposals. The Proposal of the bidder(s) whose Technical Score is less than 70 shall not be considered for further evaluation. The marks/ Technical score evaluated by Employer shall be final and binding on the Bidder(s).

28.0 SELECTION CRITERIA UNDER QCBS METHODOLOGY

28.1 After Shortlisting of Bidders in Technical Evaluation as per [Clause 27.0 above](#), the Financial Proposals of shortlisted Bidders shall be opened.

28.2 For calculation of weighted score of technical and financial proposals of the technically qualified proposal (scoring more than 70% marks), following methodology shall be used:

28.2.1 The technically qualified proposal with highest score in technical evaluation shall be given weighted technical score of 100 marks and other proposal shall be given weighted technical score that are directly proportional to their technical score on pro rata basis. Score will be rounded off to three decimal places (Or As per GeM features).

28.2.2 Similarly, the technically qualified proposal with the lowest price bid shall be given financial score of 100 marks and other proposal shall be given financial score that are inversely proportional to their prices on pro rata basis. Score will be rounded off to three decimal places (Or As per GeM features).

29.0 COMBINED SCORE

29.1 Combined score will be calculated using the formula given below:

$$S = S_T \times T_W + S_F \times F_W$$

Where,

S_T = Weighted Technical Score of Proposal under evaluation

S_F = Financial Score of Proposal under evaluation

S is the combined score, T_W and F_W are weightage assigned to Technical Proposal and Financial Proposal, which shall be 0.70 and 0.30 respectively

Note: (i) Combined Score will be rounded off to three decimal places (Or As per GeM features).

(ii) An illustration on QCBS method is attached in bidding document.

29.2 The combined score on the basis of Quality and Cost Based Selection (QCBS) of technical and financial proposals will determine the H1, H2, H3 and so on (Or as per GeM nomenclature). The bidder scoring the highest points/marks i.e. H1 bidder based on the above principles would be selected for the carrying out the work. The final decision for award of work shall be at sole discretion of Employer.

29.3 Selected bidder shall enter into a contract with Employer for execution of the said mandate.

29.4 In case two or more bidders obtain same combined score as per clause 29.1 above, proposal with highest technical score shall be selected as successful bidder. In case where technical score of such bidders are also found to be same, bidder having higher MAAT Value shall be considered as successful bidder.

30.0 e-Reverse Auction (e-RA)

The electronic Reverse Auction (e-RA) is not applicable.

31.0 DISCREPANCIES AND ADJUSTMENT OF ERRORS

31.1 The RfP documents are mutually explanatory of one another. If there are varying or conflicting provisions made in any one of the RfP documents, CTUIL shall be deciding authority with regard to the intention of the document.

31.2 Any error in description, quantity or rate in the price schedule of the Proposal Form or any omission there from shall not vitiate the Contract or release the Bidder from the execution of the whole or any part of the works comprised therein according to entire scope of work as specified in the RfP Documents.

31.3 The Bidder should ensure that the price(s) furnished at more than one place in the Proposal are consistent with each other.

In case of any discrepancy between the Lump Sum quoted price on the GeM portal and uploaded Price breakup by the bidder with H1 score (as per clause No. 29 of Conditions of Contract, Section-III of RfP Documents), the Lump Sum quoted price on the GeM portal shall prevail. In such case, the Employer shall ask the bidder with H1 score for revised price breakup matching the total Lump Sum price on the GeM portal, through e-mail.

In case of above condition, if the Bidder with H1 score does not provide price breakup within 3 (three) working days from the date of intimation by employer, its proposal may be rejected, and the amount of Proposal Security shall be forfeited.

31.4 The Employer will determine whether each Proposal is of acceptable quality, is generally complete and is substantially responsive to the RfP documents. For purposes of this determination a substantially responsive Proposal is one which conforms to all the terms and conditions of the RfP documents without material deviations, objections, conditionalities or reservations. A material deviation, objections, conditionalities or reservations is one (i) that affects in any substantial way the scope, quality or performance of the contract (ii) that limits in any substantial way, inconsistent with the RfP documents, the Employer's rights or the successful Consultant's obligations under the contract, or (iii) whose rectification would unfairly affect the competitive positions of the other Consultants who are presenting substantially responsive Proposals. The Employer's determination of Proposal's responsiveness is to be based on the contents of the Proposal itself without re-course to extraneous evidence.

31.5 A Proposal determined as not substantially responsive will be rejected by the Employer and may not subsequently be made responsive by the Bidder by correction of the non-conformity.

31.6 The Employer may waive any minor informality or non-conformity or irregularity in a Proposal, which does not constitute a material deviation, provided such waiver does not prejudice or affect the relative ranking of any Consultant.

32.0 CONFIDENTIALITY AND CONTACTING THE EMPLOYER

32.1 After the public opening of proposals, information relating to the examination, clarification, and evaluation of proposals and recommendations concerning awards shall not be disclosed to Bidders or other persons not officially concerned with this process until the publication of contract award. From the time of proposal opening to the time of contract award, if any Bidder wishes to contact the Employer on any matter related to its proposal, it should do so in writing.

32.2 Any effort by a Bidder to influence the Employer in the Employer's proposal evaluation, proposal comparison or contract award decisions may result in rejection of the Bidder's proposal. The Employer shall be the sole judge in this regard.

33.0 AWARD CRITERIA

33.1 Subject to [Clause 29.0 above](#), the Employer will award the contract to the successful bidder through GeM portal (also referred to as the H1 Bidder) whose Proposal has been determined to be substantially responsive and to be the highest scoring Proposal.

33.2 The mode of contracting with the successful Consultant will be as per below:

The successful Bidder, determined as per [Clause 29.0 above](#), shall be awarded a single contract for the entire scope of works for providing all services as specified in the Contract Documents.

34.0 EMPLOYER'S RIGHT TO ACCEPT ANY PROPOSAL AND TO REJECT ANY OR ALL PROPOSALS

The Employer reserves the right to accept or reject any proposal and to annul the bidding process and reject all proposals at any time prior to award of Contract, without thereby incurring any liability to the Bidders. In case of annulment, all proposals submitted and specifically, proposal securities shall be promptly returned to the Bidders.

35.0 GEM CONTRACT ORDER

35.1 Prior to the expiration of the period of Proposal validity, the Employer will notify the successful Bidder through GeM Portal in the form of GeM Contract Order that its Proposal has been accepted. The GeM Contract Order will constitute the formation of the contract.

35.2 The Employer shall publish the results on its website, identifying the proposal and Specification numbers and the following information: (i) name of each Bidder who submitted a proposal; (ii) name of responsive Firms after evaluation of First Envelope; (iii) name of the winning Firm, and the price it offered.

The Employer shall promptly respond in writing to any unsuccessful Bidder who, after GeM Contract Order in accordance with above, requests in writing the grounds on which its proposal was not selected.

36.0 VOID

37.0 CONTRACT PERFORMANCE GUARANTEE/ PERFORMANCE SECURITY

37.1 The successful Bidder to whom the work is awarded shall be required to furnish a Contract Performance security in favour of the Employer. The performance security shall, at the Consultant's option, be in the form of a crossed bank draft/pay order /banker certified cheque in favour of Employer or in the Form of unconditional Bank Guarantee in proforma enclosed as *Annexure-A to this Conditions of Contract*, from a bank acceptable to the owner, within fifteen Days (15) after the date of Award of the contract as per Clause 35.0 above.

Alternatively, if performance security is to be submitted in favor of CTUIL, the same can be submitted as online payment through National Electric Funds Transfer (NEFT)/Real-

time gross settlement (RTGS). Details of Bank Account for transfer of tender through NEFT/RTGS are as follows:

Beneficiary Name : Central Transmission Utility of India Ltd
Bank Name : ICICI Bank
Branch Address : Plot No. 2, Sec-29, Gurgaon, Haryana
Account No. : 057205000382
IFSC Code : ICIC0000572

The copy of Online Payment Acknowledgement generated subsequent to the payment shall be submitted by the Consultant.

37.2 No interest shall be payable by the Employer on the performance Security.

37.3 During execution of contract the Consultant, after submission of Performance Security in form of a crossed bank draft/pay order /banker certified cheque/ online payment through IMPS/NEFT, may opt to furnish the Performance Security in form of bank guarantee for the same amount and as per same terms of the Contract. On acceptance by the Employer of Performance Security submitted in the form of Bank Guarantee following receipt of confirmation from the issuing Bank, the said amount shall be refunded.

37.4 The Bank Guarantee for Performance Security are to be provided by the Consultant, which should be issued either:

(a) by a Public Sector Bank located in India, or

(b) a scheduled Indian Bank having paid up capital (net of any accumulated losses) of Rs. 1,000 Million or above (the latest annual report of the Bank should support compliance of capital adequacy ratio requirement), or

(c) by a foreign bank or a subsidiary of a foreign bank, acceptable to the Owner, with overall international corporate rating or rating of long-term debt not less than A- (A minus) or equivalent by a reputed rating Consultant. Further, the Bank Guarantee should be confirmed by either (i) its corresponding bank located in India; or (ii) a Public Sector Bank located in India; or (iii) a scheduled commercial private bank located in India as per para (b) above

37.5 The CPG amount shall be equal to **Five percent (5%) of the total Contract Price (Incl GST)** in accordance with the terms and conditions specified in the contract and in the RfP documents. The Contract performance Guarantee shall be **valid till the expiry of Ninety (90) days beyond scheduled date of final acceptance of work (i.e. till date of expiry of validity of Contract)**. However, if the contract period is extended then the validity of the Contract Performance Guarantee is to be correspondingly extended by the Consultant.

37.6 The contractor has the option to submit BG (towards Performance Security) using SFMS Platform.

At the time of issuance of the BG (including its extensions), in order to avail BG verification through SFMS facility, the issuing Bank will input the IFSC code as SBIN0017313 which is the bank of the beneficiary i.e. Central Transmission Utility of India

Limited (CTUIL), in the Advising Bank field in their Trade Finance Portal for BG issue. The Account details of CTUIL for the purpose of Bank Guarantee (towards Bid Security) to be issued using SFMS Platform are as given below:

- Account No. : 40007029694
- IFSC Code : SBIN0017313
- Branch : CAG-II New Delhi (17313)

Following additional paragraph regarding issuance of Bank Guarantee through SFMS Platform consisting of the following should be added at the end of the proforma of the Bank Guarantee (i.e. end paragraph of the Bank Guarantee preceding the signatures of the issuing authority of the BG)

“This Guarantee has been issued using SFMS Platform and the requisite communication in this regard has been forwarded to the Beneficiary Bank.”

In addition to the above, the Bank Guarantee (towards Performance Security) should be submitted in the Physical form as specified in [Sub-Clause 37.1 above](#).

37.7 The Contract performance Guarantee is intended to secure the performance of the entire contract. However, it is not to be construed as limiting the damages stipulated in other clauses in the RfP documents.

37.8 The Contract Performance Guarantee will be returned to the Consultant, without any interest, at the end of validity period as mentioned at [Clause 37.5 above](#) and on successful completion of scope of the work, whichever is later.

38.0 FRAUD AND CORRUPT PRACTICES

38.1 The Bidders and their respective officers, employees, agents and advisers shall observe the highest standard of ethics during the Selection Process. Notwithstanding anything to the contrary contained in this RfP, employer shall reject a proposal without being liable in any manner whatsoever to the Bidder, if it determines that the Bidder has, directly or indirectly or through an agent, engaged in corrupt practice, fraudulent practice, coercive practice, undesirable practice or restrictive practice (collectively the “Prohibited Practices”) in the Selection Process.

38.2 Without prejudice to the rights of Employer, if a Bidder or Consultant, as the case may be, is found by the employer to have directly or indirectly or through an agent, engaged or indulged in any corrupt practice, fraudulent practice, coercive practice, undesirable practice or restrictive practice during the Selection Process, or after the issue of the notification of Award, such bidder or Independent Engineer shall not be eligible to participate in any tender or RfP issued by Employer during a period of 2 (two) years from the date such bidder or Independent Engineer, as the case may be, is found by Employer to have directly or through an agent, engaged or indulged in any corrupt practice, fraudulent practice, coercive practice, undesirable practice or restrictive practice, as the case may be.

38.3 For the purposes of this Section, the following terms shall have the meaning hereinafter respectively assigned to them:

“Corrupt Practice” means offering, giving, receiving, or soliciting anything of value to influence the action of Employer official(s) in the procurement process.

“Fraudulent Practice” means any act including suppression/ misrepresentation of facts, submissions of forged/ false documents, making false declarations etc. that knowingly or recklessly misleads, or attempts to mislead, a party to obtain a financial gain or benefit, or to avoid an obligation, or to influence procurement process to the detriment of interest of the Employer, including collusive practices among bidders (prior to or after bid submission) to establish bid prices at artificial, non-competitive levels and to deprive Employer of the benefits of competitive prices.

“collusive practice” shall also include an arrangement between two or more parties designed to achieve an illegitimate purpose to the detriment of interest of Employer.

“coercive practice” is impairing or harming, or threatening to impair or harm, directly or indirectly, any party or the property of the party to influence improperly the actions of a party;

“Obstructive practice” means

(a) deliberately destroying, falsifying, altering or concealing of evidence material to the investigation or making false statements to investigators in order to materially impede investigation into allegations of a corrupt, fraudulent, coercive, or collusive practice; and/ or threatening, harassing or intimidating any party to prevent it from disclosing its knowledge of matters relevant to the investigation or from pursuing the investigation,
or

(b) acts intended to materially impede the exercise of the contractual rights or audit or access to information

In persuasions of its policy, the Employer will sanction a firm or individual, including declaring ineligible, either indefinitely or for a stated period of time, to be awarded a contract if it at any time determines that the firm has, directly or through an agent, engaged in corrupt, fraudulent, collusive, coercive or obstructive practices in competing for, or in executing, a contract.

39.0 TIME FOR COMMENCEMENT AND COMPLETION OF WORK

39.1 The Consultant shall commence work from the Effective Date of Contract (i.e., **15 days from the date of issuance of GeM Contract Order**) and without prejudice to [Clause 46.0 below](#) hereof.

39.2 The Consultant shall attain Completion of the work within the time as specified in the Section - IV: SCC or within such extended time to which the Contractor shall be entitled under [Clause 48.0](#) hereof.

40.0 CONTRACT PRICE

40.1 The Contract Price shall be as specified in GeM Contract order to be generated through GeM portal. The Contract Price shall be FIRM and FIXED.

41.0 TERMS OF PAYMENTS

41.1 In accordance with the provisions of RfP documents, the Employer shall pay the Consultant in the following manner and at the following times after fulfilling the following requirements:

- (i) Submission of Performance Security as per [Clause 37.0 above](#).
- (ii) Submission of Declaration regarding engagement of Key personnel as per format "Form-3" provided in Bidding Document.
- (iii) Submission of Declaration regarding field engineer experts as per format "Form-4" provided in Bidding Document.

Payments will be made in Indian Rupees unless otherwise agreed between the parties. Payment shall be made to consultant in the following manner:

S.N.	Milestones	Payment
1.	Pro-rata monthly payment for entire course of contract upon submission of the monthly progress report in prescribed format	90% of Monthly payment
2.	Upon submission & Approval of the Completion Report/Final Report	Balance Payment

41.2 Terms of Payment in case of Extension/Foreclosure of Work:

41.2.1 In case of extension of work for a period provided by employer or in case of foreclosure of work, pro-rata monthly payment shall be made on the same terms and conditions as stipulated at Clause 41.1 (1) above.

41.2.2 Balance payment shall be made on same terms and conditions as stipulated at Clause 41.1 (2) above upon submission and approval of Completion/final report and acceptance of "Deliverables" as specified in Section-II: ToR.

41.3 The above payments shall be made after deducting therefrom such other amounts as may be deductible or recoverable under the Contract.

41.4 No interest is admissible on amounts payable by the Employer.

41.5 Applicable GST will be paid/reimbursed as GeM terms & Conditions.

42.0 PROCEDURE OF PAYMENT

42.1 All payments shall be made against GST invoices to be raised by the Consultant(s) as specified under the GST Act and related Rules, Notifications, etc as notified by the Government in this regard along with submission of Declaration regarding engagement of Key personnel as per format "Form-3" and Declaration regarding field engineer experts as per format "Form-4" provided in Bidding Document.

In the event that the Consultant fails to provide the invoice in the form and manner prescribed under the GST Act and Rules along with submission of Declaration regarding engagement of Key personnel as per format "Form-3" and Declaration regarding field engineer experts as per format "Form-4" provided in Bidding Document, Employer shall not be liable to make any payment against such invoice.

All the invoices of payment shall be supported by necessary documents and submitted in quadruplicate for the certification of Engineer-in-Charge for which he will require a maximum time of fifteen (15) days before the same are submitted for processing the payment of amount admitted. The Employer shall pay the consultant all the payments and other costs within fifteen (15) days of certification by the Engineer-in-Charge of the amount payable for the services. Wherever technically feasible, such payments shall be made electronically only as per details of Bank Account furnished by consultant alongwith their Proposal. In the event, there is any query in respect of any item of such invoice requiring clarification, the Engineer-in-Charge shall notify the same within 15 days of receipt of such invoice by the Employer that such a query has arisen, and both the parties shall endeavour to reach an agreement within a period of 30 days thereafter. If no mutual agreement can be reached within a period of forty-five (45) days after receipt of the invoices by the Engineer-in-Charge, the Employer shall make payment against the balance of invoice (original amount less the amount in question) to the consultant within fifteen (15) days thereafter i.e., within sixty (60) days from the date of receipt of invoice by the Engineer-in-Charge. The invoice for the balance amount under question shall be separately submitted for future consideration of the Owner.

42.2 CTUIL is registered on TReDS (Trade Receivables Discounting System) platforms namely i.e. RXIL (Receivable Exchange of India Limited), M1-xchange (Mynd Solutions Private Limited) and Invoicemart (A.TreDS Limited) and the facility of the same may be availed by Micro, Small and Medium Enterprises (MSMEs) for payment.

43.0 TAXES, DUTIES AND INSURANCE

43.1 All charges such as but not limited to insurance charges, license fees, etc. as applicable to the subject contract shall be included in the quoted price. CTUIL shall not bear any expenditure whatsoever on this account. The liability of CTUIL shall only be limited to payment of applicable GST.

However, if there is difference in SAC classification and corresponding rate of GST of an item as quoted by the Consultant in its proposal and SAC and corresponding rate of GST as interpreted under any interpretation/ judgment/ Notification/ Circular issued under the GST law before or after the award of contract, GST reimbursable to the Consultant shall be lower of the GST applicable at the rate as quoted in the proposal or actual GST paid/payable by the Consultant for that item.

43.2 Tax liability, if any, on deputation of any of the consultant's Personnel shall also be borne by the consultant and shall be the responsibility of the Consultant as per Tax Laws of India.

43.3 The Contractor shall comply with all tax laws in force in India. The Contractor shall indemnify and hold harmless the Employer from and against any and all liabilities, interest, damages, claims, fines, penalties and expenses of whatever nature arising or resulting from the violation of such tax laws by the Contractor or its personnel, including the Subcontractors and their personnel.

43.4 The Consultant shall be liable to take /maintain all necessary insurances at its own cost.

44.0 HANDLING OF DOCUMENTS

44.1 All documents prepared by the Independent Engineer in connection with the services to be provided by the Independent Engineer shall be the property of the Employer. As and when required or upon termination/completion of the consultancy work, the aforesaid documents prepared specifically for this Assignment (including originals) shall be handed over to the Employer before final acceptance or thereafter. The Independent Engineer can retain one copy of the documentation (including working papers) relating to advice or report it may provide as a part of this assignment subject to confidential obligation specified in [Clause 44.2 below](#). Further, the documents to be handed over to the Employer would not include the internal checklist and discussion/review notes prepared.

44.2 The Independent Engineer shall take all necessary steps to ensure confidential handling of all matters pertaining to any information developed or acquired by him from Employer/TSP under terms of the contract or in performance thereof. Independent Engineer, under no circumstances, shall share the data/document provided by TSP with any third party failing which Independent Engineer shall be liable for legal consequences arising due to breach in this aspect.

44.3 The Independent Engineer shall not prepare articles or photographs for publication or speeches about the work or contracts in which Employer has an interest without prior written consent of Employer.

44.4 The Independent Engineer shall take necessary steps to ensure that all persons employed on any work in connection with this contract have noticed that the Indian Official Secrets Acts, 1923 (XIX of 1923) applies to them and shall continue to apply even after the execution of such work(s) under the contract.

45.0 INDEPENDENT ENGINEER'S PERSONNEL

45.1 General

The Independent Engineer shall employ and provide such qualified and experienced Personnel as may be required to carry out the Services.

45.2 Deployment of Key Personnel

45.2.1 The designations, names, roles in carrying out the Services by each of the Independent Engineer's Key personnel shall be provided as per **Attachment-2** of the Bidding Document. Further, the CV in prescribed format for each expert shall be furnished by the consultant along with the bid.

45.2.2 Consultant must deploy their experts within 15 days from the issuance of GeM Contract Order.

45.3 Approval of Key Personnel

The Key Personnel listed at **Attachment-2** shall be approved by the Employer. No other Professional Personnel shall be engaged without prior approval of the Employer.

45.4 Substitution of Key Personnel

45.4.1 Except as the Employer may otherwise agree, no changes shall be made to the Key Personnel whose CVs have been submitted and accepted/evaluated during the Bid. If, for any reason beyond the reasonable control of the Independent Engineer, such as resignation, retirement, death, medical incapacity, among others, it becomes necessary to replace any of the Key Personnel, the Independent Engineer shall provide as a replacement a person of equivalent or better qualifications.

However, any substitution due to resignation shall be permitted only after approval of Employer and subject to reduction of remuneration equal to 5% (Five per cent) of the monthly remuneration specified for the Key Personnel who is proposed to be substituted.

45.4.2 If the Employer (i) finds that any of the Personnel has committed serious misconduct or has been charged with a criminal action, or (ii) has reasonable cause to be dissatisfied with the performance of any of the Personnel, then the Consultants shall, at the Employer's written request provide a replacement with qualifications acceptable to the Employer.

45.4.3 Substitution of Key Personnel (s), due to reasons provided at [Clause 45.4.1 and 45.4.2 above](#), should be submitted to Employer for approval before deployment. No substitution shall be allowed without prior approval of the employer. However, in some compelling situations some key personnel is substituted without approval of the Employer, IE shall submit the request for approval of substitution as soon as possible. Remuneration towards such substituted personnel shall be kept on hold and may be paid only after approval of Employer. In case such substitution is found to be not suitable, and approval is not accorded by the Employer, no remuneration shall be paid for the period of such deployment.

The Independent Engineer shall have no claim for additional costs arising out of or incidental to any removal and/or replacement of Personnel.

45.4.4 Substitution of Key Personnel, due to reasons not covered under Clause 45.4.1 and 45.4.2 above, shall be permitted only after approval of Employer subject to reduction of remuneration equal to 5% (Five per cent) of the monthly remuneration specified for the Key Personnel who is proposed to be substituted. In the case of a second substitution, such reduction shall be equal to 10% (Ten per cent) of the monthly remuneration specified for the Key Personnel who is proposed to be substituted. Maximum 02 (Two) substitutions shall only be allowed under the subject contract, if not covered under Clause 45.4.1 and 45.4.2 above.

45.4.5 VOID

45.4.6 In the case of extension of contract, the Consultant can propose one-time replacement of each key personnel without attracting any penalty or reduction in remuneration, subject to approval of the Employer taking into consideration the progress of work. The qualifications of replacements shall be better or equivalent to the original key personnel. Any further replacement will be governed as per contract provisions.

45.5 **Penalty for Non-deployment**

In case key personnel is not deployed by consultant, no remuneration shall be paid for that period plus additional deduction shall be made at the rate of 15% (Fifteen per cent) of the remuneration specified for the Key Personnel in the contract as a penalty. Further, non-deployment of Key personnel for consecutive 2 months shall be treated as default and action may be taken in line with [clause 50.0 below](#).

Note:

- (i) Qualification mentioned in cl. 45.0 refers to the marks obtained by experts during evaluation as per Annexure-I to Section-III_QR.
- (ii) An illustration for substitution of Key Personnel is attached herewith.

46.0 **PENALTY FOR DELAY IN SERVICES**

46.1 Monthly Progress Report shall be submitted before the 12th day of every month. In case the service start date is after 12th day of the month, the first report shall be submitted after completion of succeeding calendar month.

46.2 If the report is submitted between 12th to 19th day of the month, 0.5% of monthly due payment plus GST per day shall be deducted as penalty from the next due monthly payment.

46.3 Further, if the report is submitted after 19th day of the month, total 5% of monthly due payment plus GST shall be deducted as penalty from the next due monthly payment.

47.0 **LIABILITY OF THE CONSULTANT**

47.1 The Independent Engineer's liability under this Agreement shall be determined by the Applicable Laws and the provisions hereof.

47.2 Any mistake or inadequacy appear in the documents submitted by the Independent Engineer, the Independent Engineer shall perform at its own initiative and no extra cost to Employer, all such services as shall be necessary to remedy the said mistake or inadequacy.

47.3 The Independent Engineer shall be further liable for the consequences resulting from errors and commissions due to negligence or from inadequacy on its part or on the part of its employees or associates or experts to the extent of the fees actually received by the Independent Engineer.

48.0 EXTENSION OF CONSULTANCY WORK

Employer may in its discretion provide extension by giving written notice to consultant for a period:

- i. Upto 06(six) months on the same rate, terms and conditions under this contract.
- ii. Further extension beyond 48.0(i), but not greater than 01(one) year with 10% escalation in rates of the awarded contract on same terms & conditions.

Reasons and Causes for extension cannot be attributable to Independent Engineer.

49.0 FORECLOSURE OF CONSULTANCY WORK

49.1 The Employer may be giving written notice to the Independent Engineer to foreclose the contract at any time for its convenience or for any cause or reasons which cannot be attributed to the Independent Engineer. The notice of foreclosure shall specify the foreclosure is for Employer's convenience and the date upon which such termination becomes effective.

49.2 The services that are completed and ready for final reporting within thirty (30) days after the consultant's receipt of notice of foreclosure shall be submitted to the Employer at the same rates, terms and conditions as stipulated at [Sub-Clause 41.3 above](#).

50.0 TERMINATION FOR DEFAULTS:

50.1 The Employer may without prejudice to any other remedy for breach of contract, by written notice of default sent to the Independent Engineer, terminate the contract in whole:

- a) if the Independent Engineer fails to deliver any or all of the services within the time period(s) specified in the contract or any extension thereof granted by the Employer in writing.
- b) if the Independent Engineer fails to perform any other obligation(s) under the contract; or
- c) if the Independent Engineer in either of the above circumstances, does not cure its failure within a period of 30 days after receipt of the default notice from the Employer.

50.2 In the event of Employer terminating the contract, pursuant to clause 50.1. the Employer shall forfeit the submitted CPG (Contract Performance Guarantee). Further, the Employer may get the services done, upon such terms and in such manner as it deems appropriate, similar to those not rendered and the Independent Engineer shall be liable to the Employer for any excess costs for such similar services. However, The Independent engineer shall be paid for the services provided up to the date of termination provided no adverse findings in executed works.

51.0 TERMINATION FOR INSOLVENCY

51.1 The Employer may at any time terminate the contract by giving written notice to the Independent Engineer, without compensation to the Independent Engineer, if the Independent Engineer becomes bankrupt or otherwise insolvent, provided that such termination will not prejudice or affect any right of action or remedy which has accrued or will accrue thereafter to the Employer.

52.0.0 SETTLEMENT OF DISPUTE

52.1.0 If any dispute of any kind whatsoever shall arise between the Employer and the Contractor in connection with or arising out of the Contract, including without prejudice to the generality of the foregoing, any question regarding its existence, validity or termination, or the execution of the Facilities, whether during the progress of the Facilities or after their completion and whether before or after the termination, abandonment or breach of the Contract, the parties shall seek to resolve any such dispute or difference, to the extent possible, amicably by mutual consultation.

52.1.1 If the parties fail to resolve such a dispute or difference by mutual consultation, then the dispute shall be referred by the Contractor to the Engineer In Charge (EIC), who, within a period of thirty (30) days after being requested by Contractor to do so, shall give written notice of his decision.

52.1.2 The decision/instruction of the Engineer In Charge (EIC) shall be deemed to have been accepted by the Contractor unless notified by the Contractor of his intention to refer the matter for Arbitration/Conciliation within thirty (30) days of such decision/instruction.

52.1.3 In the event the Engineer In Charge (EIC) fails to notify his decision as aforesaid within thirty (30) days, the Contractor, if he intends to go for Arbitration/Conciliation, shall notify his intention to the Engineer In Charge (EIC) within 30 days of expiry of the first mentioned period of thirty days failing which it shall be deemed that there are no dispute or difference between the Employer and the Contractor.

52.1.4 In case of dispute or difference between the Employer and the Contractor, if the Employer intends to go for Arbitration/Conciliation, he shall notify such intention to the Contractor.

52.1.5 All disputes or differences in respect of which the decision, if any, of the Engineer In Charge (EIC) and/or the Head of the Implementing Authority has not become final or binding as aforesaid shall be settled by arbitration/conciliation in the manner provided herein below.

53.1.0 ARBITRATION

53.1.1 In the event of any question, dispute or difference arising out of or in connection with this work, whether during the progress of the work after its completion, abandonment or breach of contract, the same shall be referred for arbitration.

The arbitration shall be conducted by a sole arbitrator in case the amount of claim is less than Rs. 25 Crore and by three member arbitral tribunal in case the amount of claim is greater than Rs. 25 Crore.

Sole Arbitration

The sole Arbitrator shall be chosen from a panel of empanelled Arbitrators maintained by POWERGRID/CTUIL. The same shall comprise of retired Judges and retired Senior executives of PSUs other than POWERGRID/CTUIL. Further, the choice of sole Arbitrator shall be governed by the amount of claim in the following manner:

Sl no	Claim amount	Work Experience/Qualifications
1	< Rs. 10 Crore	Sole arbitrator-Retired Senior Executives of PSUs other than POWERGRID or CTUIL/Retired Distt Judges/High Court Judges.
2	Rs.10 Crore- Rs.25 Crore	Sole arbitrator- Retired High Court/Supreme Court Judges

- (a) In case of invocation of arbitration by CTUIL, CTUIL shall, within 30 days, send a list of names of 3 arbitrators from its list/database of Arbitrators and the contractor shall within the period of further 30 days select any one person to act as "Sole Arbitrator", which will be confirmed by CTUIL and matter will be referred to such appointed Arbitrator for further arbitration proceedings.
- (b) In case of invocation of arbitration by the Contractor, the Contractor shall request CTUIL for its database of Arbitrators/ chose from the list of Arbitrators available on POWERGRID's/CTUIL's website, and the contractor shall, within 30 days, select any one Arbitrator from the above to act as "Sole Arbitrator", which will be confirmed by CTUIL within 30 days and matter will be referred to such appointed Arbitrator for further arbitration proceedings.

If the parties fail to appoint sole arbitrator within sixty (60) days after receipt of a notice from the other party invoking Arbitration, the appointment of sole arbitrator shall be done by Courts as per the provisions of Indian Arbitration and Conciliation Act, 1996 or any statutory modification thereof.

Three member arbitral tribunal

The arbitration shall be conducted by three arbitrators, who are retired High Court/Supreme Court Judges, one each to be nominated by the Contractor and the

Employer and the third to be appointed by both the arbitrators in accordance with the Indian Arbitration & conciliation Act. If either of the parties fails to appoint its arbitrator within sixty (60) days after receipt of a notice from the other party invoking the Arbitration clause, the arbitrator appointed by the party invoking the arbitration clause shall become the sole arbitrator to conduct the arbitration. In case of failure of the two arbitrators appointed by the parties to reach upon a consensus regarding appointment of presiding Arbitrator, within a period of 30 days from the appointment of the arbitrator appointed subsequently, the presiding arbitrator shall be appointed by Courts as per the provisions of Arbitration & conciliation Act.

- 53.1.2 The cost of arbitral proceedings inter-alia including the Arbitrators' fee, logistics and any other charges shall be equally shared by both parties.

In case of Sole Arbitrator, the fees to be paid to the sole Arbitrator shall be as per the terms of empanelment in POWERGRID/CTUIL whereas in case of the three member tribunal, the Arbitrator's fees shall be as agreed upon by the Arbitrators in line with the Arbitration & Conciliation Act. However, the expenses incurred by each party in connection with the preparation, presentation, etc. of its proceedings shall be borne by each party itself.

- 53.1.3 The language of the arbitration proceedings and that of the documents and communications between the parties shall be English. The arbitration shall be conducted in accordance with the provisions of the Indian Arbitration and Conciliation Act, 1996 or any statutory modification thereof. The venue of arbitration shall be New Delhi.

- 53.1.4 The decision of the sole arbitrator/ the majority of the arbitrators, as the case may be, shall be final and binding upon the parties. In the event of any of the sole arbitrator/ any of the aforesaid arbitrators dying, neglecting, resigning or being unable to act for any reason, it will be lawful for the parties to nominate another sole arbitrator/ another arbitrator in place of the outgoing arbitrator.

- 53.1.5 Notwithstanding the above, in case the contractor is a Central Public Sector Enterprise (CPSE)/Government Organization or Department then the dispute/ difference (other than those related to taxation matters) between the Employer and the Contractor shall be settled through Administrative Mechanism for Resolution of CPSEs Disputes (AMRCD) as mentioned in DPE OM No. 4(1)/2013-DPE(GM)/FTS-1835 dated 22.05.2018 and DPE OM No. DPE-GM-05/0003/2019-FTS-10937 dated 20.02.2020. The decision through AMRCD will be final and binding on all the concerned.

- 53.1.6 During settlement of disputes and arbitration proceedings, both parties shall be obliged to carry out their respective obligations under the Contract.

53.2.0 CONCILIATION

- 53.2.1 The mechanism of Dispute resolution through Conciliation shall be available in cases where the amount involved in the dispute exceeds INR 1 Cr.

- 53.2.2 The settlement of Disputes through conciliation mechanism shall be done by the Conciliation Committee of Independent Experts (CCIE) constituted by Ministry of Power,

Govt. of India as per the procedure outlined in its OM dated 29.12.2021 as detailed herein below and its subsequent amendments/modifications (if any).

- 53.2.2.1 Each member of CCIE would be paid a sum of Rs. 50,000/- as sitting fee per sitting. In addition, Rs. 5,000/- per sitting will be paid for local transport charges for each day of proceeding. The conciliation proceedings shall be completed in each case through 5 sittings in a period of not more than three months from the date the reference made to the CCIE. In exceptional cases, if any dispute so merits, the time period may be extended at the discretion of Conciliation Committee (with reasons to be recorded in writing), for a further period of three months. In case, a particular dispute requires more than 5 sittings, the same may be held at the discretion of the CCIE but with a cap on payment of fee for 5 sittings only. The local transport charges shall, however, be paid as provided for each day of sitting beyond the 5 sittings.
- 53.2.2.2 The CCIE shall hold day to day sitting at the Headquarter of the Employer or New Delhi and may hold as many sittings every month as it deems appropriate keeping in view the volume of work.
- 53.2.2.3 All expenditure incurred on the conciliation proceedings including payment of fees to the Conciliators, office space, logistic, secretarial assistance and other incidental expenses etc. shall be borne by the Employer initially. Thereafter it shall be shared equally by both parties on completion of the conciliation process.
- 53.2.3 The procedure of CCIE shall not be treated as alternate arbitration proceedings where both parties come with Statement of claims/defence, arguments/counter arguments, rejoinders, written submissions etc., aided by their respective lawyers. The forum of CCIE is a conciliation forum, where mutual give and take constitutes the essence, rather than strict legal positions of the parties. Hence, the parties are expected to be brief and to the point before the committee with regard to their respective stance and view the exercise in the spirit of conciliation / settlement.
- 53.2.4 The Standard Operating Procedure for the conciliation mechanism shall be as follows:**
- i) On receipt of a reference from the Contractor for conciliation of dispute, the concerned Executive Director of the Employer shall send a communication within 7 working days thereby inviting the Contractor to depute a team of their representatives to interact with the Employer to crystallize the issues and prepare the agenda containing the gist on each dispute.
 - ii) Once a conciliation request has been raised by the contractor, within 30 days the same shall be referred to the CCIE in the event of the matter remaining unresolved internally.
 - iii) The Employer will also be free to suggest the option of resolution of disputes by conciliation in case a dispute has arisen. The contractor may select any one of the CCIEs as constituted by MOP after leaving out those CCIEs which are unavailable due to work load or any other reason as maintained by Central Electricity Authority (CEA).

- iv) The Conciliation process shall be conducted under Part III of the Arbitration and Conciliation Act, 1996.
 - v) The Conciliation Committee would either be able to resolve and settle the dispute(s) between the parties, or the process may fail.
 - vi) In the event of the conciliation proceedings being successful, the parties to the dispute would sign the written settlement agreement and the conciliators would authenticate the same. Such settlement agreement would then be binding on the parties in terms of Section 73 of the Arbitration and Conciliation Act, 1996.
 - vii) After successful conclusion of Conciliation, proceedings, the Parties to the conciliation process, have to undertake and complete all necessary actions for implementation of the terms of settlement within a period of 30 days from execution of settlement agreement, unless a different timeline not exceeding 60 days is agreed upon in settlement agreement. All pending claims of parties, in connection with the dispute, before any other legal forum are to be withdrawn within the said 30 days in pursuance of the settlement agreement.
 - viii) In case of failure of the conciliation process at the level of the Conciliation Committee, the parties may withdraw from conciliation process and take recourse to Arbitration proceedings or the laid down legal process of Courts.
- 53.2.5 In cases of disputes pending before the Arbitration Tribunals or the Courts, both the parties (i.e. Employer and Contractor) need to agree to explore the possibilities of conciliation through the Conciliation Committee of Independent Experts. In case of such agreement, an appropriate reference shall be made to the Conciliation Committee, upon which the Committee shall proceed to examine such reference(s). In the event of the conciliation proceedings being successful, the parties to the dispute would sign the written settlement agreement and the conciliators would authenticate the same. Such settlement agreement would then be binding on the parties in terms of Section 73 of the Arbitration and Conciliation Act, 1996. However, the parties may resume the Arbitration proceedings or take recourse to any other legal remedies in the event of the conciliation proceedings not being successful.
- 53.2.6 During settlement of disputes and conciliation proceedings, both parties shall be obliged to carry out their respective obligations under the Contract.

54.0 GOVERNING LAWS

This consultancy work shall be governed by the Indian Laws for the time being in force and the Delhi Courts shall have the exclusive jurisdiction.

55.0 SUSPENSION OF THE OBLIGATION

- 55.1 The obligations stipulated in this RfP documents can only be suspended in the case of work, in the event of Force Majeure as defined in Clause 56.0 herein below or as a result of an agreement between the parties.
- 55.2 In the event of Force Majeure, neither of the Parties may be considered in default of its obligations under the terms of the RfP documents.

56.0 FORCE MAJEURE

56.1 Force Majeure is hereby defined as any cause which is beyond the control of the Independent Engineer or the Employer as the case may be, which they could not foresee or with a reasonable amount of diligence could not have foreseen and which substantially affect the performance of contract such as:

- a) Natural phenomena including but not limited to floods, droughts, earthquakes and epidemics.
- b) Acts of any government, domestic or foreign, including but not limited to war, declared or undeclared, priorities, quarantines, embargoes.

provided either party shall within 15 days from the occurrence of such a cause notify the other in writing of such causes.

56.2 The Independent Engineer or the Employer shall not be liable for delays in performing his obligations resulting from any force majeure cause as referred to and/or defined above. The date of completion will, subject to hereinafter provided, be extended by a reasonable time even though such cause may occur after Independent Engineer's performance of his obligations has been delayed for other causes.

57.0 SUB-CONTRACT

Sub-contracting of the assignment will not be allowed. The appointed Consultant shall be solely responsible for all the required deliverables.

58.0 NO WAIVERS

If Employer, in any instance, does not insist upon strict performance of any of the terms of the assignment, it shall not be construed as a waiver or relinquishment in the future till the assignment is in force and shall not relieve Consultant of any of its responsibilities under the assignment.

59.0 INSTRUCTIONS AND NOTICES

59.1 All notices to be given on behalf of Employer and all other actions to be taken on its behalf may be given or taken by the Engineer-in-Charge or any officer for the time being entrusted with the functions, duties and powers of the Engineer-in-Charge.

59.2 All instructions, notices and communications, etc., shall be given in writing and if sent by registered / speed post to the last known place of business of the consultant, shall be deemed to have been served on the dates when in the ordinary course of post these would have been delivered to him.

60.0 BANKRUPTCY

60.1 If the Independent Engineer has become bankrupt or have a receiving order made against him or compound with his creditors or being a corporation commence to be wound up,

not being a voluntary winding up for the purposes only or amalgamation or reconstruction or carry on their business under a receiver for the benefit of their creditors or any of them, Employer shall be at liberty.

- a) to terminate the assignment forthwith without any notice in writing to the Independent Engineer or to the liquidator or receiver or to any person in whom the Independent Engineer may become vested.
- b) to give such liquidator receiver or other person the option of carrying out the consultancy assignment subject to their providing a guarantee for the due and faithful performance of the assignment upto an amount to be determined by Employer.

61.0 PROGRESS REPORT

61.1 The Independent Engineer shall prepare and submit to the Engineer-in-Charge progress report Monthly in line with Section-II: ToR, showing the progress and status of the 'Works being performed by him including such materials as charts, networks and photograph (if any) as per the directives of the Engineer-in-Charge. Draft formats of progress reports shall be finalized in consultation with the Engineer-in-Charge.

61.2 It is understood that submission of such reports and reviews thereof by Employer shall not absolve the Independent Engineer of his responsibility of timely completion of the Assignment as per the time schedule indicated herein.

62.0 EMPLOYER'S RIGHT

Employer reserves the right for the following: -

62.1 Rejection of any or all offers without assigning any reason whatsoever.

62.2 Rejection of any offer with incomplete scope of works or which is an incomplete offer in the opinion of the Employer.

62.3 Review of the work performed by the Independent Engineer and ask for any clarification and changes/modifications to the work performed by the Independent Engineer. Such changes shall be mutually discussed and agreed between the Employer and the Independent Engineer and the same shall be incorporated by the Independent Engineer in his work without any cost to the Employer and without any dilution of the responsibility of the Independent Engineer.

62.4 Seek changes in the Independent Engineer's personnel deployed for the assignment on grounds of quality of work, timely completion or other reasons. Such changes shall be mutually discussed and agreed between the Employer and the Independent Engineer without any cost to the Employer and without any dilution of the responsibility of the Independent Engineer. Further, the replaced personnel shall have similar or higher competency level and designation.

63.0 CORRESPONDENCE AND CONTRACT CO-ORDINATION PROCEDURE

All correspondence during execution of the contract shall be made as per following procedure:

- 63.1 On all matters pertaining to execution of the contract, the Independent Engineer shall directly interact with the Engineer-in-Charge.
- 63.2 All correspondence from the Employer to the Independent Engineer shall be made with the full-time coordinator i.e. Team Leader cum Project Manager to be identified by the Independent Engineer and agreed by Employer.

64.0 INDEMNITY

Independent Engineer shall indemnify the Employer and every member, officers and employees of the Employer against all actions, proceedings, claims, demands, costs and expenses whatsoever arising out of any negligent act of omission or failure by Independent Engineer in the performance of Independent Engineer's obligations under this Contract.

---End of Section-III---

Minimum Qualification Criteria for Appointment of Independent Engineer for “Transmission system for evacuation of power from Rajasthan REZ Ph-IV (Part-3: 6GW) [Bikaner complex]: Part-B”. Spec. No. CTUIL/IE/2024-25/58

Bidder must read the minimum Qualification criteria provided herein, Proposals of only those bidders who satisfy the minimum qualification will be considered for further evaluation using QCBS methodology. The proposal shall be submitted by an individual firm and not a JV/Consortium.

Employer reserves the right to waive minor deviations if they do not materially affect the capability of the Bidder to perform the contract.

1.1 Technical Experience of firm:

Bidder must meet the following minimum criteria as on the originally scheduled date of bid opening i.e. **16.12.2024**:

- i. The Bidder must have experience in providing consultancy services* as Independent Engineer/ Lender’s Engineer/ Project Management Consultant for minimum one (01) no. of 220kV or above completed Transmission Line of line length 25 kms or above during last 10 years.
- ii. The Bidder must have experience in providing consultancy services* as Independent Engineer/ Lender’s Engineer/ Project Management Consultant for minimum one (01) no. of 220kV or above completed Substation# having atleast one (01) no. 220kV or above class ICT during last 10 years.

Note:

* *Consultancy services means services provided for review of engineering design/drawings & supervision of construction works.*

Substation mentioned anywhere in this document shall mean Substation / Switchyard / Gas Insulated Substation (GIS)/ Air Insulated Substation (AIS).

In case bidder is a holding company, the technical experience referred to in clause 1.1 above shall be of that holding company only (i.e. excluding its subsidiary / group companies). In case bidder is a subsidiary of a holding company, the technical experience referred to in clause 1.1 above shall be of that subsidiary company only (i.e. excluding its holding company).

1.2 Condition of Eligibility of Key Personnel:

The bidder must provide following key experts with qualifications and competence for the Assignment as mentioned below:

- a) **Project Management expert/Team Leader:** Graduate in Electrical/ Mechanical / Civil Engineering having at least 8 years' experience in EHV transmission projects and have worked in at least two (2) assignments for 345kV or above transmission project as team leader/Project Manager.
- b) **Transmission Line expert:** Graduate in Electrical/ Civil Engineering having at least 5 years' experience in EHV transmission line projects and have worked in at least two (2) assignments for 345kV or above transmission line projects.
- c) **Substation expert:** Graduate in Electrical Engineering having at least 5 years' experience in EHV transmission substation projects and have worked in at least two (2) assignments for 345kV or above substation projects.
- d) **Field Engineer-I (Substation):** Graduate/Diploma in Electrical/Civil Engineering having at least 2 years' experience in construction of EHV transmission substation projects.
- e) **Field Engineer-II (Substation):** Graduate/Diploma in Electrical/Civil Engineering having at least 2 years' experience in construction of EHV transmission substation projects.
- f) **Field Engineer-I (Transmission Line):** Graduate/Diploma in Electrical/Civil Engineering having at least 2 years' experience in construction of EHV transmission line projects.
- g) **Field Engineer-II (Transmission Line):** Graduate/Diploma in Electrical/Civil Engineering having at least 2 years' experience in construction of EHV transmission line projects.

1.3 Financial Position:

- a) The Bidder shall have received a sum of minimum of INR 1 (One) Crore per annum as professional fees for last 03 (three) financial years. For the avoidance of doubt, professional fees hereunder refer to fees received by the Applicant for providing

advisory or consultancy services to its clients and shall not include professional fee for undertaking dispute resolution proceeding before courts, tribunals or arbitrators.

b) The bidder should have positive net-worth for last three financial years.

Note: In case bidder is a holding company, the financial position referred to in clause 1.3 above shall be of that holding company only (i.e. excluding its subsidiary / group companies). In case bidder is a subsidiary of a holding company, the financial position referred to in clause 1.3 above shall be of that subsidiary company only (i.e. excluding its holding company).

1.4 The bidder should be duly incorporated under the relevant laws and should possess ISO 9001 certificate.

1.5 The Bidder shall furnish documentary evidence in support of the qualifying requirement stipulated as above.

2.0 Technical Evaluation Criteria through QCBS Methodology: Only those Bidders who meet the minimum qualification criteria specified above shall qualify for evaluation through QCBS methodology. Minimum Technical Score shall be **Seventy (70)** for qualifying in further evaluation process. The Proposal of the bidder(s) whose Technical Score is less than 70 shall not be considered for further evaluation.

Sl. No.	Criteria		Scoring Criteria		Maxi score	Document required
1	Consultancy Firm Profile				15	
A	Cumulative professional fees for last three (3) financial years. <i>[please refer 1.3 (a) above]</i>		Rs. 3 Cr. To 5 Cr.	10 marks	15	Please refer Note (1)
			More than Rs. 5 Cr. and upto 7Cr.	12 marks		
			More than Rs. 7 Cr.	15 marks		
2	Relevant Experience of Consultancy Firm (during last 10 years as on the originally scheduled date of bid opening)				40	
	Experience as Project Management Consultant/ Independent Engineer/ Lender's Engineer in construction of Transmission projects for	220kV or above Transmission line	One (01) number	15 marks	20	Please refer Note (2)
			Two (02) numbers	18 marks		
			Three (03) or more numbers	20 marks		
		220kV or above Substation	One (01) number	15 marks	20	
			Two (02) numbers	18 marks		

			Three (03) or more numbers	20 marks		
3	Key personnel Qualification and relevant Experience				45	
A	Team Leader cum Project Manager					
	Graduate Engineer (Electrical/Mechanical/Civil) having experience in relevant work as per clause 1.2 (a) above.	08 years or more but less than 12 years	12 marks	15	Please refer Note (3)	
		12 years or more but less than 16 years	14 marks			
		16 years and more	15 marks			
B	Transmission line Expert					
	Graduate Engineer (Electrical/Civil) having experience in relevant work as per clause 1.2 (b) above.	05 years or more but less than 08 years	7 marks	9	Please refer Note (3)	
		08 years or more but less than 12 years	8 marks			
		12 years and more	9 marks			
C	Substation Expert					
	Graduate Engineer (Electrical) having experience in relevant work as per clause 1.2 (c) above.	05 years or more but less than 08 years	7 marks	9	Please refer Note (3)	
		08 years or more but less than 12 years	8 marks			
		12 years and more	9 marks			
D	Field Engineer-I (Substation)					
	Graduate/Diploma Engineer (Electrical/Civil) having experience in relevant work as per clause 1.2 (d) above	02 years but less than 04 years	1 mark	3	Please refer Note (3)	
		04 years but less than 06 years	2 marks			
		06 years and more	3 marks			
E	Field Engineer-II (Substation)					
	Graduate/Diploma Engineer (Electrical/Civil) having experience in relevant work as per clause 1.2 (e) above	02 years but less than 04 years	1 mark	3	Please refer Note (3)	
		04 years but less than 06 years	2 marks			
		06 years and more	3 marks			

F	Field Engineer-I (Transmission Line)				
	Graduate/Diploma Engineer (Electrical/Civil) having experience in relevant work as per clause 1.2 (f) above	02 years but less than 04 years	1 mark	3	Please refer Note (3)
		04 years but less than 06 years	2 marks		
		06 years and more	3 marks		
G	Field Engineer-II (Transmission Line)				
	Graduate/Diploma Engineer (Electrical/Civil) having experience in relevant work as	02 years but less than 04 years	1 mark	3	Please refer Note (3)
		04 years but less than 06 years	2 marks		
		06 years and more	3 marks		
		Total (Marks)		100	

Note (1): The bidder shall enclose with its Proposal, certificate(s) as per format provided in Bidding Document from its Statutory Auditors/ Chartered Accountant stating its total revenues from professional fees during each of the past three financial years.

Note (2): The bidder shall submit documents in support of meeting the technical experience in the form of LOA/ Work order & completion certificate/ payment certificate or any other document evidencing the same.

Note (3): The bidder shall submit CV of the key personnel as per format provided in Bidding Document, along with details of experience and self-attested copies of Qualification certificate & employment proofs.

Note (4): The same Project Manager, Transmission line Expert & Substation Expert cannot be engaged for more than 4 (four) nos. of active contracts awarded by CTUIL.

Annexure-A to Section-III: Conditions of Contract

ANENXURE-A

1. PROFORMA BANK GUARANTEE FOR CONTRACT PERFORMANCE

(To be stamped in accordance with Stamp Act)

The non-judicial stamp paper should be in the name of issuing bank

Bank Guarantee No.

Date.....

NOA/Contract No.....

.....[Name of Independent Engineer].....

To: [Name and address of the Employer]

Dear Ladies and/or Gentlemen,

We refer to the Contract ("the Contract")

Generated through GeM portal on(insert date of the GeM Contract Order).....
between you and M/s (Name of Independent Engineer),

(or)

vide GeM Contract Order Generated through GeM portal on (insert date of the
GeM Contract Order)...by you to M/s (Name of Independent
Engineer),

having its Principal place of business at(Address of Independent Engineer)
..... and Registered Office at(Registered address of Independent
Engineer) ("**the Independent
Engineer**") concerning (Indicate brief scope of work)
for the complete execution of the (insert name of Package alongwith name of the
Project)..... [Applicable for Bank Guarantees issued by Consultant for those Contracts
awarded to them]

By this letter we, the undersigned,(insert name & address of the issuing bank)
....., a Bank (which expression shall include its successors, administrators, executors
and assigns) organized under the laws of and having its
Registered/Head Office at(insert address of registered office of the bank)..... do
hereby irrevocably guarantee payment to you up to i.e., five
percent (5%) of the Contract Price until ninety (90) days beyond scheduled date of final
acceptance of work i.e., upto and inclusive of (dd/mm/yy).

Annexure-A to Section-III: Conditions of Contract

We undertake to make payment under this Letter of Guarantee upon receipt by us of your first written demand signed by your duly authorized officer declaring the *Independent Engineer* to be in default under the Contract and without cavil or argument any sum or sums within the above-named limits, without your need to prove or show grounds or reasons for your demand and without the right of the *Independent Engineer* to dispute or question such demand.

Our liability under this Letter of Guarantee shall be to pay to you whichever is the lesser of the sum so requested or the amount then guaranteed hereunder in respect of any demand duly made hereunder prior to expiry of the Letter of Guarantee, without being entitled to inquire whether or not this payment is lawfully demanded.

This letter of Guarantee shall remain in full force and shall be valid from the date of issue until ninety (90) days beyond scheduled date of final acceptance of work i.e. upto and inclusive of (dd/mm/yy) and shall be extended from time to time for such period (not exceeding one year), as may be desired by M/s. on whose behalf this Letter of Guarantee has been given.

Except for the documents herein specified, no other documents or other action shall be required, notwithstanding any applicable law or regulation.

Our liability under this Letter of Guarantee shall become null and void immediately upon its expiry, whether it is returned or not, and no claim may be made hereunder after such expiry or after the aggregate of the sums paid by us to you shall equal the sums guaranteed hereunder, whichever is the earlier.

All notices to be given under shall be given by registered (airmail) posts to the addressee at the address herein set out or as otherwise advised by and between the parties hereto.

We hereby agree that any part of the Contract may be amended, renewed, extended, modified, compromised, released or discharged by mutual agreement between you and the *Independent Engineer*, and this security may be exchanged or surrendered without in any way impairing or affecting our liabilities hereunder without notices to us and without the necessity for any additional endorsement, consent or guarantee by us, provided, however, that the sum guaranteed shall not be increased or decreased.

No action, event or condition which by any applicable law should operate to discharge us from liability hereunder shall have any effect and we hereby waive any right we may have to apply such law so that in all respects our liability hereunder shall be irrevocable and, except as stated herein, unconditional in all respects.

“Notwithstanding anything contained herein:

Annexure-A to Section-III: Conditions of Contract

1. Our liability under this Bank Guarantee shall not exceed _____ (value in figures)_____ [_____ (value in words)_____].
2. This Bank Guarantee shall be valid upto _____(validity date)_____.
3. We are liable to pay the guaranteed amount or any part thereof under this Bank Guarantee only & only if we receive a written claim or demand on or before _____ (validity date) _____."

For and on behalf of the Bank

[Signature of the authorised signatory(ies)]

Signature_____

Name_____

Designation_____

POA Number_____

Contact Number(s): Tel._____ Mobile_____

Fax Number_____

email_____

Common Seal of the Bank_____

Witness:

Signature_____

Name_____

Address_____

Contact Number(s): Tel._____ Mobile_____

email_____

Note :

Annexure-A to Section-III: Conditions of Contract

1. For the purpose of executing the Bank Guarantee, the non-judicial stamp papers of appropriate value shall be purchased in the name of Bank who issues the 'Bank Guarantee'.
2. The Bank Guarantee shall be signed on all the pages by the Bank Authorities indicating their POA nos. and should invariably be witnessed.
3. The Bank Guarantee should be in accordance with the proforma as provided. However, in case the issuing bank insists for additional paragraph regarding applicability of ICC Publication No. 758, the following may be added at the end of the proforma of the Bank Guarantee [*i.e., end paragraph of the Bank Guarantee preceding the signature(s) of the issuing authority(ies) of the Bank Guarantee*]:

Quote

This guarantee is subjected to uniform Rules for Demand Guarantee, ICC publication No. 758.

Unquote

4. **At the time of issuance of the Bank Guarantee (including its extensions) through SFMS facility, the issuing bank will input the IFSC code of Beneficiary Bank as mentioned at clause 12.1.4 Section-III, conditions of contract in their Trade Finance Portal.**
Additional paragraph regarding issuance of the Bank Guarantee through SFMS Platform (if applicable), the following should be added at the end of the proforma of the Bank Guarantee [*i.e., end paragraph of the Bank Guarantee preceding the signature(s) of the issuing authority(ies) of the Bank Guarantee*]:

"This Guarantee has been issued using SFMS Platform and the requisite communication in this regard has been forwarded to the Beneficiary Bank."

सेंट्रल ट्रान्समिशन यूटिलिटी ऑफ इंडिया लिमिटेड
CENTRAL TRANSMISSION UTILITY OF INDIA LIMITED
(Wholly Owned Subsidiary of Power Grid Corporation of India Limited)
(A Government of India Enterprise)

SPECIAL CONDITIONS OF CONTRACT (SCC)

(Section - IV: Special Conditions of Contract)

for

Appointment of Independent Engineer for "Transmission system for evacuation of power from Rajasthan REZ Ph-IV (Part-3: 6GW) [Bikaner complex]: Part-B"

(Spec. No. CTUIL/IE/2024-25/58)

(This document is meant for exclusive purpose of bidding against this specification only and shall not be transferred, reproduced or otherwise used for purpose other than that for which it is specifically issued)

SPECIAL CONDITIONS OF CONTRACT (SCC)

The following Special Conditions of Contract (Section-IV) shall amend and/or supplement the provisions in the Conditions of Contract (Section-III):

Sl. No.	Conditions of Contract Clause Ref. No.	Special Conditions of Contract (SCC)
1.	Clause 1.1	<p><u>Supplement Clause 1.1 of Conditions of Contract with the following:</u></p> <p><u>Address of Employer:</u> Central Transmission Utility of India Limited (A wholly owned subsidiary of POWERGRID) 10th floor, IRCON International Tower-1, Plot No. 16 Sector-32, Gurugram - 122001, Haryana</p> <p>Kind Attention: Mr. Dwaipayan Sen (Manager, C&M-CTUIL / Mr. Rahul (Manager, C&M-CTUIL)</p> <p>Mobile: +91-9205287422/9205472328 Email: dwaipayan@powergrid.in; rahul.prasad@powergrid.in;</p> <p>Bidders shall note that all the correspondence shall be made to CTUIL only.</p>
2.	Clause 2.1	<p><u>Supplement Clause 2.1 of Conditions of Contract with the following:</u></p> <p>Central Transmission Utility of India Limited (CTUIL) will select Independent Engineer for “Transmission system for evacuation of power from Rajasthan REZ Ph-IV (Part-3: 6GW) [Bikaner complex]: Part-B”. Spec. No. CTUIL/IE/2024-25/58.</p>
3.	Clause 2.2	<p><u>Supplement Clause 2.2 of Conditions of Contract with the following:</u></p> <p>The Proposals have to be submitted by an individual firm.</p>
4.	Clause 5.2	<p><u>Supplement Clause 5.2 of Conditions of Contract with the following:</u></p> <p><u>Venue, date and time for Pre-Bid Meeting:</u></p> <p>The Bidder’s designated representative is invited to attend a pre-bid meeting, which will take place at the venue and time as given below: Central Transmission Utility of India Limited</p>

Sl. No.	Conditions of Contract Clause Ref. No.	Special Conditions of Contract (SCC)				
		<p>(A wholly owned subsidiary of POWERGRID) 10th floor, IRCON International Tower-1, Plot No. 16 Sector-32, Gurugram - 122001, Haryana</p> <p>Kind Attention: Mr. Dwaipayan Sen (Manager, C&M-CTUIL) / Mr. Rahul (Manager, C&M-CTUIL)</p> <p>Mobile: +91-9205287422/9205472328 Email: dwaipayan@powergrid.in; rahul.prasad@powergrid.in;</p> <p>Date: 02.12.2024 Time: 1100Hrs</p>				
5.	Clause 11.1	<p><u>Supplement Clause 11.1 of Conditions of Contract with the following:</u></p> <p>Amount of Proposal Security:</p> <table border="1" data-bbox="635 882 1513 1173"> <thead> <tr> <th data-bbox="635 882 1153 960">Package Name</th> <th data-bbox="1153 882 1513 960">Proposal Security Amount</th> </tr> </thead> <tbody> <tr> <td data-bbox="635 960 1153 1173">Appointment of Independent Engineer for "Transmission system for evacuation of power from Rajasthan REZ Ph-IV (Part-3: 6GW) [Bikaner complex]: Part-B". Spec. No. CTUIL/IE/2024-25/58</td> <td data-bbox="1153 960 1513 1173">INR 2,21,000/-</td> </tr> </tbody> </table>	Package Name	Proposal Security Amount	Appointment of Independent Engineer for "Transmission system for evacuation of power from Rajasthan REZ Ph-IV (Part-3: 6GW) [Bikaner complex]: Part-B". Spec. No. CTUIL/IE/2024-25/58	INR 2,21,000/-
Package Name	Proposal Security Amount					
Appointment of Independent Engineer for "Transmission system for evacuation of power from Rajasthan REZ Ph-IV (Part-3: 6GW) [Bikaner complex]: Part-B". Spec. No. CTUIL/IE/2024-25/58	INR 2,21,000/-					
6.	Clause 11.3	<p><u>Supplement Clause 11.3 of Conditions of Contract with the following:</u></p> <p>Validity of Proposal Securities: Proposal Security for Subject Package shall be valid for 225 days [=180+45, i.e. Bid validity plus 45 days] from Bid Submission end date.</p>				
7.	Clause 15.0	<p><u>Supplement Clause 15.0 of Conditions of Contract with the following:</u></p> <p><u>Deadline for submission of Soft copy part of Bid is:</u> Date: 16.12.2024 /Time: 1500 hrs. [Indian Standard Time (e-procurement server time)].</p> <p><u>Deadline for submission of Hard copy part of Bid:</u> Date: 16.12.2024 Time: up to 15:00 hours [Indian Standard Time (e-procurement server time)]</p>				

Sl. No.	Conditions of Contract Clause Ref. No.	Special Conditions of Contract (SCC)				
		Proposal submission timelines will be defined as per the e-Procurement server clock only.				
8.	Clause 19.1	<p><u>Supplement Clause 19.1 of Conditions of Contract with the following:</u></p> <p>Time and date for Bid Opening – First Envelope:</p> <p>Date: 16.12.2024 Time: 15:30 hours onwards (Indian Standard Time)</p> <p>Bidder will get the information regarding bid opening date and time from GeM Portal (https://gem.gov.in/). Hence, bidder shall keep updated themselves about bid opening event by checking GeM Portal regularly.</p>				
9.	Clause 39.2	<p><u>Supplement Clause 19.1 of Conditions of Contract with the following:</u></p> <p><u>Completion Period of subject Package:</u></p> <table border="1"> <thead> <tr> <th>Package Name</th> <th>Completion Period (in months) from the effective date of GeM Contract Order</th> </tr> </thead> <tbody> <tr> <td>Appointment of Independent Engineer for “Transmission system for evacuation of power from Rajasthan REZ Ph-IV (Part-3: 6GW) [Bikaner complex]: Part-B”. Spec. No. CTUIL/IE/2024-25/58</td> <td>22 (Twenty-two)</td> </tr> </tbody> </table>	Package Name	Completion Period (in months) from the effective date of GeM Contract Order	Appointment of Independent Engineer for “Transmission system for evacuation of power from Rajasthan REZ Ph-IV (Part-3: 6GW) [Bikaner complex]: Part-B”. Spec. No. CTUIL/IE/2024-25/58	22 (Twenty-two)
Package Name	Completion Period (in months) from the effective date of GeM Contract Order					
Appointment of Independent Engineer for “Transmission system for evacuation of power from Rajasthan REZ Ph-IV (Part-3: 6GW) [Bikaner complex]: Part-B”. Spec. No. CTUIL/IE/2024-25/58	22 (Twenty-two)					

----- End of Section-IV -----

QCBS ILLUSTRATION

1. EVALUATION OF TECHNICAL PROPOSALS (in line with clause 26.0, Section-III of RfP Document):

Bidders Detail	Obtained Technical Marks
Bidder 1	92
Bidder 2	85
Bidder 3	55
Bidder 4	75

2. SHORTLISTING OF BIDDERS IN TECHNICAL EVALUATION (in line with clause 27.0, Section-III of RfP Document)

- Since the minimum Technical Score requirement for further evaluation is 70 out of 100, Bidder 3 is rejected.

3. SELECTION CRITERIA UNDER QCBS METHODOLOGY (in line with clause 27.0, Section-III of RfP Document)

A. Financial Bid Evaluation

Bidders Detail	Financial Bid
Bidder 1	1,30,000
Bidder 2	1,20,000
Bidder 4	1,00,000

B. Weighted Technical Score (S_T):

Bidders Detail	Weighted Technical Score = (Obtained Technical Marks/ Maximum Technical Marks) x 100
Bidder 1	$(92/92) \times 100 =$ 100.000
Bidder 2	$(85/92) \times 100 =$ 92.391
Bidder 4	$(75/92) \times 100 =$ 81.522

C. Financial Score (S_F):

Bidders Detail	Financial Score = (Lowest Bid Price/ Bid Price) x 100
Bidder 1	$(1,00,000/1,30,000) \times 100 =$ 76.923
Bidder 2	$(1,00,000/1,20,000) \times 100 =$ 83.333
Bidder 4	$(1,00,000/1,00,000) \times 100 =$ 100.000

4. COMBINED SCORE (in line with clause 27.0, Section-III of RfP Document)

Bidders Detail	Combined Score = S_T x T_W + S_F x F_W	Rank
Bidder 1	(100.000 x 0.70 + 76.923 x 0.30) = 92.077	H1
Bidder 2	(92.391 x 0.70 + 83.333 x 0.30) = 89.674	H2
Bidder 4	(81.522 x 0.70 + 100 x 0.30) = 87.065	H3

T_W and F_W are weightage assigned to Technical Proposal and Financial Proposal, which shall be **0.70** and **0.30** respectively.

Bidder 1 with H1 Rank is successful bidder

Typical Illustration for Substitution of Key Personnel

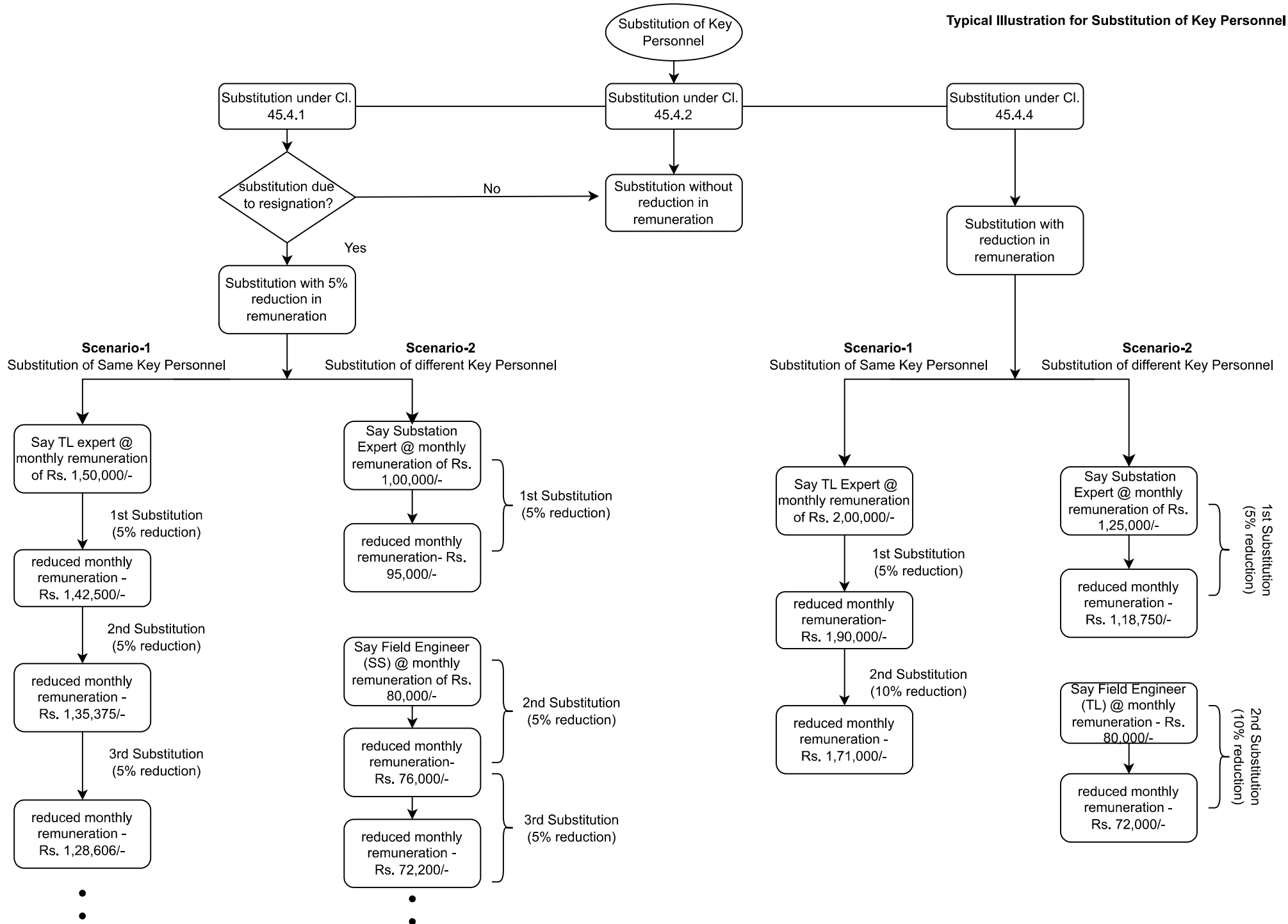

सेंट्रल ट्रान्समिशन यूटिलिटी ऑफ इंडिया लिमिटेड
CENTRAL TRANSMISSION UTILITY OF INDIA LIMITED
(Wholly Owned Subsidiary of Power Grid Corporation of India Limited)
(A Government of India Enterprise)

(Section – V: Proposal Forms (Technical & Financial), Attachments & Schedules)

for

Appointment of Independent Engineer for “Transmission system for evacuation of power from Rajasthan REZ Ph-IV (Part-3: 6GW) [Bikaner complex]: Part-B”

(Spec. No. CTUIL/IE/2024-25/58)

(This document is meant for exclusive purpose of bidding against this specification only and shall not be transferred, reproduced or otherwise used for purpose other than that for which it is specifically issued)

Package Name:
Spec. No.:

Letter of Proposal

(To be Submitted in First Envelope Bid i.e. in Technical Cover on Portal)

Proposal Ref. No.

Date:

To,

C&M

Central Transmission Utility of India Limited

(A wholly owned subsidiary of POWERGRID)

10th floor, IRCON International Tower-1, Plot No. 16

Sector-32, Gurugram – 122001, Haryana

Name of Package:

Dear Sir,

- 1.0 Having examined the RfP Documents, including Amendment/Addenda the receipt of which is hereby acknowledged, we the undersigned, offer to deliver services as per provisions of Terms of Reference (ToR) under the above-named package in full conformity with the said RfP Documents. In accordance with provisions of the RfP Documents, we hereby submit our Proposal, in two envelopes i.e. First Envelope & Second Envelope (to be opened subsequently).
- 1.1 We meet eligibility requirements and have no conflict of interest in accordance with Clause 2.5 Section-III (Conditions of Contract).
- 1.2 We shall render all the services under the subject assignment from within India only. No services are envisaged to be taken from sources / personnel from abroad.
- 2.0 Attachments to the Letter of Proposal:
- 2.1 In line with the requirement of the RfP Documents, we enclose herewith the following Attachments to this Letter of Proposal:

Package Name:
Spec. No.:

- (a) Attachment 1 : Bid Security or documentary evidence in support of exemption of Bid Security (*submission of Hard copy in "Original" and uploading of Scanned Copy*).
- (b) Attachment 2 : Bidder's Credentials towards Technical Evaluation Criteria (*uploading of Scanned Copy and Uploading of Scanned Copies of documentary evidence in support of Bidder's qualification*)

The documentary evidence of the Bidder's eligibility to bid shall establish to the Employer's satisfaction that the Bidder, at the time of submission of its bid, is eligible as defined in ITB Clause 2.

The documentary evidence defining (i) the constitution or legal status; (ii) The principal place of business; (iii) The place of incorporation (for bidders who are corporations); or the place of registration and the nationality of the Owners (for applicants who are partnerships or individually-owned firms); (iv) In support of meeting the Technical experience, self-certified copy of Contract/ Award Letter and Utility Certificate.

The complete annual reports together with Audited statement of accounts of the company for last three years of its own (separate) immediately preceding the date of submission of bid. The Bidder shall also furnish documentary evidence/ declaration regarding Financial re-structuring of the company, if any.

If the opening of the bids pursuant to Clause 19.0 or the Technical Evaluation pursuant to ITB Clause 26.2 is carried out after 30th September, the bidder shall be required to submit the complete annual reports together with Audited statement of accounts of the company for the immediately preceding Financial Year except in cases where the Board of the Company/ Registrar of Companies has granted extension of time for finalization of accounts, for which the bidder has to submit requisite documentary evidence. In case of Bidder's failure to submit the same along with the Bid or subsequently pursuant to Clause 20.0, the Bid shall be rejected.

- (c) Attachment 3 : Undertaking regarding unconditional acceptance of Provisions of RfP documents (*uploading of Scanned Copy*)
- (d) Attachment 4 : Information for E-payment, PF details and declaration regarding Micro/Small & Medium Enterprises (*uploading of Scanned Copy*)
- (e) Attachment 5 : Power of Attorney (*submission of Hard copy in "Original" and uploading of Scanned Copy*)

A power of attorney, duly notarized, indicating that the person(s) signing the Proposal has(ve) the authority to sign the Proposal and thus that the Proposal is binding

Package Name:
Spec. No.:

upon the Bidder during full period of its validity, in accordance with Clause 12.0 below.

Further, Bidder shall furnish copy of partnership deed, in case of partnership firm, Memorandum and Articles of Association, in case of limited company, ownership certificate in case of sole or proprietorship firm.

Bidder shall furnish this PoA in its own format.

- (f) Attachment 6 : Certification by the Bidder as per DoE Order in line with Clause 2.2 (*uploading of Scanned Copy*)
- (g) Attachment 7 : Affidavit of Self certification regarding Minimum Local Content in line with PPP-MII order (*submission of Hard Copy in 'Original'*), to be submitted on a non-judicial stamp paper of Rs. 100/-.

In line with the PPP-MII order, the bidder shall submit the Affidavit of self-certification, in original, indicating the percentage of Local Content and certifying that the item offered meets the Minimum Local Content and shall give details of the location(s) at which value addition is made, as prescribed in the PPP-MII Order, on a non-judicial stamp paper of Rs. 100/-.

Further, Self-certification submitted by the bidder may be verified randomly by the committee constituted as per PPP-MII order. In case of false documents/ misrepresentation of the facts, requisite action against such bidder will be taken based on the recommendation of the committee and in line with provisions of the Integrity pact.

Bidder may note that the other directions of Nodal Ministry as identified under PPP-MII order shall also be suitably considered in regard to verification/ action of the certificate

- (h) Attachment 8 : Declaration by the Bidder regarding events encountered pursuant to Clause 2.4 (*uploading of Scanned Copy*)
- (i) Attachment 9 : Integrity Pact (*submission of Hard copy in "Original" and uploading of Scanned Copy*)

The Bidder shall complete the accompanying Integrity Pact, which shall be applicable for bidding as well as contract execution, duly signed on each page by the person signing the bid and shall be returned by the Bidder in two (2) originals alongwith the Techno - Commercial Part in a separate envelope, duly superscripted with 'Integrity Pact'. The Bidder shall submit the Integrity Pact

Package Name:
Spec. No.:

on a non-judicial stamp paper of Rs. 100/-.

(j) Attachment 10 : KMP Declaration (*uploading of Scanned Copy*)

(k) Attachment 11 : Information regarding Ex-employees of CTUIL/ POWERGRID in our Organization (*uploading of Scanned Copy*)

3.0 We are a Micro and Small Enterprise (MSE) registered with, a designated Authority of GoI under the Public Procurement Policy for MSEs Order, 2012, Notification dated 01/06/2020 read in conjunction with related notifications issued from time to time for such enterprises. (To be filled by MSE Company only).

4.0 We have understood the instructions and the terms and conditions mentioned in the enquiry furnished by you and have thoroughly examined the terms and conditions laid down by you in the RfP documents for Engagement of consultant and are fully aware of the nature of consultancy services required.

4.1 We declare that as specified in Clause 9.0 of Section-III: Conditions of Contracts of RfP Documents, prices quoted by us shall be Firm & Fixed and shall not be subject to any adjustment during course of the Contract.

5.0 We declare that we are making the offer on a single source responsibility basis.

6.0 Our Proposal shall remain valid for acceptance for a period of 180 (One Hundred and Eighty) days **from Bid submission end date of the First Envelope Proposal.**

7.0 We have not made any deviations from the requirement of the RfP document and we have also not made any tampering or changes in the RfP documents on which the Proposal is being submitted and if any tampering or changes are detected at any stage, we understand the Proposal will invite summary rejection /the contract will be liable to be terminated, even if Award has been issued.

8.0 We understand that you are not bound to accept the lowest or any Proposal you may receive.

9.0 We are aware that the Price Schedule do not generally give a full description of the Work to be performed and we shall be deemed to have read the Terms of Reference and other sections of the RfP Documents to ascertain the full scope of Work while filling-in the rates and prices in Second Envelope.

10.0 We declare that prices quoted by us in second envelope includes all charges including GST. However, we understand that the GST shall be paid as per GeM terms & Conditions. We further agree that the entered prices shall be deemed to cover for the full scope as aforesaid, including overheads and profits.

Package Name:
Spec. No.:

11.0 We hereby declare that only the company, persons or firms interested in this proposal as principal or principals are named herein and that no other company person or firm other than the one mentioned herein have any interest in this proposal or in the contract to be entered into, if are awarded this contract, and that this proposal is made without any connection with any other persons, firm or party, likewise submitting a proposal and that this proposal in all respect for and in good faith without collusion or fraud.

Date :

Printed Name :

Place :

Designation :

PROPOSAL SECURITY FORM

((To be stamped in accordance with Stamp Act, the Non-Judicial Stamp Paper should be in the name of the issuing Bank. For the purpose of verification/confirmation of this Bank Guarantee by the Employer, the Bank shall indicate 2 official email ids of the authorized signatories from Issuing Branch and also of the designated higher office (Corporate Office, Zonal Office etc) in the covering letter of the Bank forwarding the Bank Guarantee.))

Bank Guarantee No.:

Date:

To: *(insert Name and Address of Employer)*

WHEREAS M/s. *(Insert name of Bidder)*..... having its Registered/Head Office at *(Insert address of the Bidder)* (Hereinafter called "the Bidder" **which expression shall include its successors, administrators, executors and assigns**) has submitted its Proposal for the performance of the Contract for *(Enter Package Name)*, under **Specification No.:** (Hereinafter called "the Bid")

KNOW ALL PERSONS by these present that WE *(insert name & address of the issuing bank)* having its Registered/Head Office at*(insert address of registered office of the bank)*..... (hereinafter called "the Bank" **which expression shall include its successors, administrators, executors and assigns**), are bound unto Central Transmission Utility of India Limited (hereinafter called "the Employer") in the sum of*(insert amount of Bid Security in figures & words)*..... for which payment well and truly to be made to the said Employer, the Bank binds itself, its successors and assigns by these presents.

Sealed with the Common Seal of the said Bank this day of 20....

THE CONDITIONS of this obligation are:

- (1) If the Bidder withdraws its Proposal during the period of proposal validity specified by the Bidder in the Bid Form; or
- (2) In case the Bidder does not withdraw the deviations proposed by him, if any, at the cost of withdrawal stated by him in the bid; or
- (3) If a Bidder does not accept the corrections to arithmetical errors identified during preliminary evaluation of his proposal pursuant to Clause 31.0 of Section-III, Conditions of Contract; or
- (4) In the case of a successful Bidder, if the Bidder fails within the specified time limit

- (i) to sign the Contract Agreement, in accordance with Clause 36.0 of Section-III (Conditions of Contract), or
 - (ii) to furnish the required performance security(ies), in accordance with Clause 37.0 of Section-III (Conditions of Contract) and/or to keep the proposal security valid as per the requirement of Clause 11.3 of Section-III (Conditions of Contract).
- or

(6) In any other case specifically provided for in RfP Document.

WE undertake to pay to the Employer up to the above amount upon receipt of its first written demand, without the Employer having to substantiate its demand, provided that in its demand the Employer will note that the amount claimed by it is due to it, owing to the occurrence of any of the above-named CONDITIONS or their combination, and specifying the occurred condition or conditions.

This guarantee will remain in full force up to and including (*insert date in line with Clause 11.3 of Section-IV, Conditions of Contract*)....., and any demand in respect thereof must reach the Bank not later than the above date.

Notwithstanding anything contained herein:

- 1. Our liability under this Bank Guarantee shall not exceed _____ (*value in figures*)_____ [*value in words*]_____.
- 2. This Bank Guarantee shall be valid upto _____(*validity date*)_____.
- 3. We are liable to pay the guaranteed amount or any part thereof under this Bank Guarantee only & only if we receive a written claim or demand on or before _____ (*validity date*) _____

For and on behalf of the Bank

[*Signature of the authorised signatory(ies)*]

Signature_____

Name_____

Designation_____

POA Number_____

Contact Number(s): Tel._____ Mobile_____

Fax Number_____

email _____

Common Seal of the Bank_____

Witness:

Signature_____

Name_____

Address_____

Contact Number(s): Tel._____Mobile_____

email_____

Note:

1. The Bank Guarantee should be in accordance with the proforma as provided. However, in case the issuing bank insists for additional paragraph regarding applicability of ICC publication No: 758, the following may be added at the end of the proforma of the Bank Guarantee [*i.e., end paragraph of the Bank Guarantee preceding the signature(s) of the issuing authority(ies) of the Bank Guarantee*]:

“This Guarantee is subject to Uniform Rules for Demand Guarantee, ICC publication No. 758.”

2. **At the time of issuance of the Bank Guarantee (including its extensions) through SFMS facility, the issuing bank will input the IFSC code of Beneficiary Bank as mentioned at *Clause 11.4 of Section-III, Conditions of Contract* in their Trade Finance Portal.**

Additional paragraph regarding issuance of the Bank Guarantee through SFMS Platform (if applicable), the following should be added at the end of the proforma of the Bank Guarantee [*i.e., end paragraph of the Bank Guarantee preceding the signature(s) of the issuing authority(ies) of the Bank Guarantee*]:

“This Guarantee has been issued using SFMS Platform and the requisite communication in this regard has been forwarded to the Beneficiary Bank.”

----- (Package Name) -----

(Credentials towards Technical Evaluation Criteria)

Bidder's Name and Address:

To:

C&M

Central Transmission Utility of India Limited

(A wholly owned subsidiary of POWERGRID)

10th floor, IRCON International Tower-1, Plot No. 16

Sector-32, Gurugram - 122001, Haryana

Dear Sir,

In support of the requirement stipulated in Evaluation Criteria (*Annexure-I to Section-III*) and additional information required as per RfP document, we furnish herewith our data/details/documents etc., along with other information, as follows:

We have submitted bid as Individual Firm.

We are furnishing the following details/ documents in support of requirement for the subject package:

- A. Attached copies of original documents defining:
 - a. The constitution or legal status;
 - b. The principal place of business;
 - c. The place of incorporation (for bidders who are corporations); or the place of registration and the nationality of the Owners (for applicants who are partnerships or individually-owned firms)
- B. Attached original & copies of the following documents
 - a. Written power of attorney of the signatory of the Bid to commit the bidder

1.0 GENERAL INFORMATION

Bidder is required to provide general information as per the following format

Sl. No.	Particulars	For individual firm
1.	Name of the Bidder	
2.	Head Office/ Registered Office Address	
3.	Place of Incorporation/ Registration	
4.	Year of Incorporation/ Registration	
5.	Correspondence Address	
6.	Nationality of	
	Owner (i)	
	Owner (ii)	
	Owner (iii)	
7.	Authorised Signatory:	
7.	Designation:	
8.	Address:	
9.	Contact No.:	
10.	e-mail address:	

2.0 Technical Experience of firm:

2.1 In line with the requirement of Experience in providing consultancy services as Independent Engineer/Lender's Engineer/Project Management Consultant in construction of Transmission projects including quality monitoring as mentioned at Sl. No. 1.1 of Minimum Qualification Criteria (*Annexure-I to Section-III*), we are providing the relevant information, alongwith documentary evidence for the project, as per the following:

(i) for 220kV or above Transmission Line project:

Number of Projects (in nos.)	
Project #1	
Name of Project	
Voltage level of Project (in kV)	
Line length of Project (in km)	
Name of the Client	
Award date of Project	
Completion date of Project	
Received Professional fees (in INR)	
Project #2	
Name of Project	
Voltage level of Project (in kV)	
Line length of Project (in km)	
Name of the Client	
Award date of Project	
Completion date of Project	
Received Professional fees (in INR)	
Project #3	
Name of Project	
Voltage level of Project (in kV)	
Line length of Project (in km)	
Name of the Client	
Award date of Project	
Completion date of Project	
Received Professional fees (in INR)	

(ii) for 220kV or above Substation project:

Number of Projects (in nos.)	
-------------------------------------	--

Project #1	
Name of Project	
Voltage level of Project (in kV)	
Number(s) of ICTs	
Voltage class of ICT	
Name of the Client	
Award date of Project	
Completion date of Project	
Received Professional fees (in INR)	
Project #2	
Name of Project	
Voltage level of Project (in kV)	
Number(s) of ICTs	
Voltage class of ICT	
Name of the Client	
Award date of Project	
Completion date of Project	
Received Professional fees (in INR)	
Project #3	
Name of Project	
Voltage level of Project (in kV)	
Number(s) of ICTs	
Voltage class of ICT	
Name of the Client	
Award date of Project	
Completion date of Project	
Received Professional fees (in INR)	

Note:

- (i) Bidder may add more projects by adding row below the above table.
- (ii) The bidder shall submit documents in support of meeting the technical experience in the form of LOA/ Work order & completion certificate/ payment certificate or any other document evidencing the same

3.0 Condition of Eligibility of Key Personnel

3.1 In line with the requirement at Sl. No. 1.2 of Minimum Qualification Criteria (*Annexure-I to Section-III*), we are providing the relevant information, along with documentary evidence, as per the following:

Sl. no	Name of the Key personnel	Role of the key personnel	Qualification of the key personnel	Experience	Documentary Evidence Attached as
.					

1.		Team Leader cum Project Manager		<input type="radio"/> 08 years or more but less than 12 years <input type="radio"/> 12 years or more but less than 16 years <input type="radio"/> 16 years and more	
2.		Transmission Line Expert		<input type="radio"/> 05 years or more but less than 08 years <input type="radio"/> 08 years or more but less than 12 years <input type="radio"/> 12 years and more	
3.		Substation Expert		<input type="radio"/> 05 years or more but less than 08 years <input type="radio"/> 08 years or more but less than 12 years <input type="radio"/> 12 years and more	
4.		Field Engineer-I (Substation)		<input type="radio"/> 02 years or more but less than 04 years <input type="radio"/> 04 years or more but less than 06 years <input type="radio"/> 06 years and more	
5.		Field Engineer-II (Substation)		<input type="radio"/> 02 years or more but less than 04 years <input type="radio"/> 04 years or more but less than 06 years <input type="radio"/> 06 years and more	
6.		Field Engineer-I (Transmission Line)		<input type="radio"/> 02 years or more but less than 04 years <input type="radio"/> 04 years or more but less than 06 years <input type="radio"/> 06 years and more	
7.		Field Engineer-II (Transmission Line)		<input type="radio"/> 02 years or more but less than 04 years <input type="radio"/> 04 years or more but less than 06 years <input type="radio"/> 06 years and more	

Kindly Tick on appropriate option

Note: The bidder shall submit CV of the key personnel as per format provided as **FORM-1, Section-V, RfP Document**, along with details of experience and self-attested

copies of Qualification certificate.

Except as Employer may otherwise agree, no changes shall be made in the Key Personnel whose CVs have been submitted and accepted/evaluated during the Bid. However, Substitution may be allowed as per Clause 45.4, Conditions of Contract, Section-III of the bidding document.

4.0 Financial Position:

4.1 In line with the requirement at Sl. No. 1.3 (a) of Minimum Qualification Criteria (*Annexure-I to Section-III*), we are providing the relevant information, alongwith documentary evidence, as per the following:

Requirement	Professional Fees received (in INR Crores)	Documentary Evidence Attached as
FY 2023-24		
FY 2022-23		
FY 2021-22		

Note: The bidder shall enclose with its Proposal, certificate(s) as per format "FORM-2" provided in Section-V of Bidding Document from its Statutory Auditors stating its total revenues from professional fees during each of the past three financial years.

4.2 In line with the requirement at Sl. No. 1.3 (b) of Minimum Qualification Criteria (*Annexure-I to Section-III*), we are providing the relevant information, along with documentary evidence, as per the following:

Sl. No.	Financial Year	Net worth (in Rs. Crores)	Documentary Evidence Attached as
1.	2023-24		
2.	2022-23		
3.	2021-22		

4.3 The complete annual reports together with Audited statement of accounts of the company for last three years of its own (separate) immediately preceding the date of submission of bid:

<i>Years preceding to the bid Submission</i>	<i>Audited Balance Sheet and Income Statements enclosed</i>	
<i>1st Year (2023-24)</i>	<input type="radio"/> Yes	<input type="radio"/> No
<i>2nd Year (2022-23)</i>	<input type="radio"/> Yes	<input type="radio"/> No
<i>3rd Year (2021-22)</i>	<input type="radio"/> Yes	<input type="radio"/> No

Kindly Tick on Yes if you have enclosed the Audited Balance Sheet

- 5.0 In line with the requirement at sl.no. 1.4 of Minimum Qualification Criteria (*Annexure-I to Section-III*), we are providing the relevant information, alongwith documentary evidence, as per the following:

Requirement	Documentary Evidence attached as
ISO 9001 certificate	

Date:.....

(Signature)

Place:.....

(Printed Name)

(Designation)

(Common Seal)

(Undertaking regarding acceptance of Provisions of RfP documents)

Bidder's Name and Address :

To:

Name :
Address :

C&M
Central Transmission Utility of India Limited
(A wholly owned subsidiary of POWERGRID)
10th floor, IRCON International Tower-1, Plot No. 16
Sector-32, Gurugram - 122001, Haryana

Dear Sir,

- 1.0 With reference to our Proposal Ref. No : ----- dated : ----- for Engagement of Independent Engineer for -----
----- Spec. No. -----,
we hereby confirm that the provisions of RfP Documents, read in conjunction with Amendment(s)/Clarification(s) (if any) issued by CTUIL are acceptable to us and we have not taken any deviation in this regard.
- 2.0 We confirm that any deviation to RfP Documents and its subsequent Amendment(s)/ Clarification as mentioned at 1.0 above, found anywhere in our Proposal, implicit or explicit shall stand unconditionally withdrawn, without any cost implication whatsoever to CTUIL.
- 3.0 Further, we hereby confirm that there are no discrepancies/inconsistencies and deviations/ omissions/ reservations in First Envelope and Second Envelope Proposals.
- 4.0 We also confirm that in case any discrepancies/ inconsistencies and deviations/ omissions/ reservations, as referred to in para 3.0 above, is observed in First Envelope and Second Envelope Proposals, the same shall be deemed as withdrawn/rectified without any financial implication, whatsoever to CTUIL. However, in case of any arithmetical errors, the same shall be governed as per the provision of Clause 31.0 of Section-III: Conditions of Contracts of the RfP documents.

Date :

Printed Name :

Place :

Designation :

(Information for E-payment, PF details and declaration regarding Micro/Small & Medium Enterprises)

Bidder's Name and Address :

To:

Name :
Address :

C&M
Central Transmission Utility of India Limited
(A wholly owned subsidiary of POWERGRID)
10th floor, IRCON International Tower-1, Plot No. 16
Sector-32, Gurugram - 122001, Haryana

Dear Sir,

We hereby authorize the Employer to make all our payments through Electronic Fund Transfer System. The details for facilitating the payments are given below: -

1	Name of the Consultant in whose favour payment is to be made	
2	Address with PIN Code and State	
	Registered Office:	
3	Correspondence Address:	
3	Name of Contact Person	
	Designation	
4	Contact Details	
	Landline(s):	
	Mobile(s):	
	Email ID :	
5	Status - Company/others [Declaration of Micro/ Small/ Medium Enterprise under Micro/ Small & Medium Enterprises Development Act 2006, if applicable]	
6	Permanent Account (PAN) No.	
7	GSTIN No.	(i) (ii) (iii)
8	PF Registration No. of the Company	
9	PF Regional Office covered (with	

	Address)	
10	Bank Details for Electronic Payment	
	Name of the Bank:	
	Address of Branch:	
	Account No.:	
	Type of Account: Current Account or Saving Account	
11	9-digit MICR code printed at bottom in middle, next to cheque no.	
12	IFSC (for RTGS)/NEFT Code (to be obtained from the Bank) Sample Cancelled Cheque to be enclosed	

I/We hereby declare that the particulars given above are correct and complete. If the transaction is delayed or credit is not affected at all for reasons of incomplete or incorrect information, I/We would not hold the employer responsible.

Date :

Printed Name :

Place :

Designation :

(Certification by the Bidder per order no. F.No.6/18/2019-PPD dated 23/07/2020 issued by Public Procurement Division, Department of Expenditure, Ministry of Finance, Government of India (DoE Order) in line with Clause 2.2 of Section-III, Conditions of Contract)

Bidder's Name and Address :

To:

Name :

Address :

C&M

Central Transmission Utility of India Limited

(A wholly owned subsidiary of POWERGRID)

10th floor, IRCON International Tower-1, Plot No. 16

Sector-32, Gurugram - 122001, Haryana

Dear Sir,

We have read and understood the provisions of Order no. F.No.6/18/2019-PPD (Order Public Procurement no.1) dated 23/07/2020 regarding "Restriction under Rule 144(xi) of General Financial Rules" and F.No.6/18/2019-PPD (Order Public Procurement no.2) dated 23/07/2020 regarding "Exclusions from Restriction under Rule 144(xi) of General Financial Rules" issued by Public Procurement Division, Department of Expenditure, Ministry of Finance, Government of India [hereinafter collectively "DoE Order"] and any subsequent modifications/Amendments, if any.

Particularly, we, the Bidder, have read the clause regarding restrictions on procurement from a 'Bidder of a country which shares a land border with India' and on sub-contracting to contractors from such countries.

We certify that we, the bidder is/are not from such a country or, if from such a country, has been registered as per provisions of the RfP Documents with the Competent Authority and will not subcontract any work to a subcontractor/sub vendor from such countries unless such subcontractor/sub vendor fulfils all requirement in this regard and is eligible to be considered. [*Where applicable, evidence of valid registration by the Competent Authority shall be attached.*]

We further declare that any misrepresentation or submission of false/forged document/information in this regard shall be dealt with as per the provisions of Integrity Pact and/or RfP Documents.

Date :

Printed Name :

Place :

Designation :

(Format for Affidavit of Self certification regarding Local Content in line with PPP-MII order, if applicable, to be provided on a non-judicial stamp paper of Rs. 100/-)

Date:

I _____ S/o, D/o, W/o, _____ Resident of _____ hereby solemnly affirm and declare as under:

That I will agree to abide by the terms and conditions of the Public Procurement (Preference to Make in India) Order, 2017 of Government of India issued vide Notification No:P-45021/2/2017 -BE-II dated 15/06/2017, its revision dated 16/09/2020 (PPP-MII Order) read in conjunction with 'Public Procurement (Preference to Make in India) to provide for Purchase Preference (linked with local content) in respect of Power Sector' order dated 16/11/2021 issued by Ministry of Power (MoP Order) and subsequent modifications/amendments if any.

That the information furnished hereinafter is correct to the best of my knowledge and belief and I undertake to produce relevant records before the procuring entity/CTUIL or any other Government authority for the purpose of assessing the local content of goods/services/works supplied by me for **Engagement of Independent Engineer for _____; Specification No.: _____**.

That the local content for all inputs which constitute the said goods/services/works has been verified by me and I am responsible for the correctness of the claims made therein.

That the 'Local Content 'as defined in the PPP-MII order in the goods/services/works supplied by me for **Engagement of Independent Engineer for _____; Specification No.: _____** is percent (%).

That the goods/services/works supplied by me for **Engagement of Independent Engineer for _____; Specification No.: _____** meet the 'Local Content 'requirement as defined in the PPP-MII order for **'Class -I local supplier'**

That the value addition for the purpose of meeting the 'Local Content 'has been made by me at (Enter the details of the location(s) at which value addition is made).

That in the event of the local content of the goods/services/works mentioned herein is found to be incorrect and not meeting the prescribed Local Content criteria, based on the assessment of procuring agency (ies)/CTUIL/Government Authorities for the

purpose of assessing the local content, action shall be taken against me in line with the PPP-MII order and provisions of the Integrity pact/ Bidding Documents.

I agree to maintain the relevant information in the Company's record for a period of 8 years and shall make this available for verification to any statutory authority.

For and on behalf of..... (Name of firm/entity)
Authorized signatory (To be duly authorized by the Board of Directors)
<Insert Name, Designation and Contact No.>

**(Declaration regarding events encountered pursuant to Clause 2.4 of Section-III
Conditions of Contract)**

Bidder's Name and Address:

To:

Name :
Address :

C&M
Central Transmission Utility of India Limited
(A wholly owned subsidiary of POWERGRID)
10th floor, IRCON International Tower-1, Plot No. 16
Sector-32, Gurugram - 122001, Haryana

Dear Sir,

1.0 In accordance with the relevant provisions of the RfP documents inter-alia including for assessment of capacity and capability, we furnish herewith our data/details/documents along with other information, as follows

Sr. No.	Event		
1.	Whether there was Termination of Contract(s) due to Consultant's / Contractor's default	<input type="checkbox"/>	Yes
		<input type="checkbox"/>	No
2.	Whether there was Encashment of CPG(s) due to non-performance	<input type="checkbox"/>	Yes
		<input type="checkbox"/>	No
3.	Firm has been referred to NCLT under Insolvency & Bankruptcy Code (<i>IRP has been appointed or Liquidation proceedings have been initiated under IBC</i>)	<input type="checkbox"/>	Yes [@]
		<input type="checkbox"/>	No

Note:

1. Information regarding events at Sl. No. 1 & 2 shall be furnished for events occurred during last one year under the contract(s) executed by you for CTUIL.

[@]2. Regarding Sl. No. 3, in case of 'Yes', following information shall be submitted additionally:

Date on which the firm has been referred to NCLT under Insolvency & Bankruptcy Code (IRP has been appointed or Liquidation proceedings have been initiated under IBC)

.....

Whether the process under IBC has been concluded (If yes, supporting documents be submitted)

Yes

No

2.0 We confirm that the above information/declarations and documents submitted in support of the same are true and correct to the best of our knowledge. We

understand that any false declaration and/or misrepresentation of facts and/or false/forged documents/information may lead to our debarment from participation in Employer tenders and that our Bid Security/Contract Performance Guarantee may be forfeited besides other actions as deemed to be appropriate as per the provisions of the RfP Documents/Integrity Pact.

Date :

Printed Name :

Place :

Designation :

INTEGRITY PACT

Between

Central Transmission Utility of India Limited
having its Registered Office at "Saudamini", Plot No. 2, Sector 29,
Gurgaon (Haryana) - 122001

hereinafter referred to as

"CTUIL",

and

[Insert the name of the Sole Bidder/Lead Partner of Joint Venture, if applicable]

having its Registered Office at _____
(Insert full Address)

and

[Insert the name of the Partner(s) of Joint Venture, if applicable]

having its Registered Office at _____
(Insert full Address)

hereinafter referred to as

"The Bidder/Contractor"

Preamble

CTUIL intends to award, under laid-down organisational procedures, contract(s) for _____ *[Insert the name of the package]*
Package and Specification Number _____ *[Insert Specification*
Number of the package]

CTUIL values full compliance with all **relevant laws of the land, rules, regulations, economic use of resources, and of fairness / transparency in its relations with its Bidders/ Contractors.**

In order to achieve these goals, CTUIL and the above named Bidder/Contractor enter into this agreement called '**Integrity Pact**' which will form a part of the bid.

It is hereby agreed by and between the parties as under:

Section I - Commitments of CTUIL

- (1) CTUIL commits itself to take all measures necessary to prevent corruption and to observe the following principles :
 - a) No employee of CTUIL, personally or through family members, will in connection with the tender, or the execution of the contract, demand, take a promise for or accept, for him/herself or third person, any material or other benefit which he/she is not legally entitled to.
 - b) CTUIL will, during the tender process treat all Bidder(s) with equity, fairness **and reason**. CTUIL will in particular, before and during the tender process, provide to all Bidder(s) the same information and will not provide to any Bidder(s) confidential/ additional information through which the Bidder(s) could obtain an advantage in relation to the tender process or the contract execution.
 - (c) CTUIL will exclude from evaluation of Bids its such employee(s) who has any **personal** interest in the Companies/Agencies participating in the Bidding/Tendering process **and all known prejudiced persons**.
- (2) **If CTUIL obtains information on the conduct of any of its employee which is a criminal offence under the IPC / PC Act, or if there be a substantive suspicion in this regard, CTUIL will inform its Chief Vigilance Officer and in addition disciplinary actions can be initiated under CTUIL's Rules.**

Section II - Commitments of the Bidder/Contractor

- (1) The Bidder/Contractor commits **itself** to take all measures necessary to prevent corruption. The **Bidder/Contractor** commits **itself** to observe the following

principles during **its** participation in the tender process and during the contract execution:

- a) The Bidder/Contractor will not, directly or through any other person or firm, offer, promise or give **to any of CTUIL's** employees involved in the tender process or the execution of the contract or to any third person any material or other benefit which it is not legally entitled to, in order to obtain in exchange an advantage of any kind whatsoever during the tender process or during the execution of the contract.
 - b) The Bidder/Contractor will not enter into any illegal **or undisclosed** agreement or understanding, whether formal or informal with other Bidders/Contractors. This applies in particular to prices, specifications, certifications, subsidiary contracts, submission or non-submission of bids or actions to restrict competitiveness or to introduce cartelization in the bidding process.
 - c) **The Bidder/Contractor shall not pass any information provided by CTUIL as part of business relationship to others and shall not commit any offence under PC / IPC Act.**
 - d) The Bidder/Contractor of foreign origin shall disclose the name and address of the Agents/representatives in India, if any, involved directly or indirectly in the Bidding. Similarly, the Bidder/Contractor of Indian Nationality shall furnish the name and address of the foreign principals, if any, involved directly or indirectly in the Bidding.
 - e) The Bidder/Contractor will, when presenting his bid, disclose any and all **payments made**, or committed to or intends to make to agents, brokers or any other intermediaries in connection with the award of the contract and/or with the execution of the contract.
 - f) The Bidder/Contractor will not misrepresent facts or furnish false/forged documents/information in order to influence the bidding process or the execution of the contract to the detriment of **CTUIL**.
 - g) **The Bidder/Contractor shall ensure adoption of Integrity Pact by its Sub-contractors and shall be responsible for the same.**
- (2) The Bidder/Contractor will not instigate third persons to commit offences outlined above or be an accessory to such offences.

Section III- Disqualification from tender process and exclusion from future contracts

- (1) If the Bidder, before contract award, has **committed a transgression** through a violation of Section II or in any other form such as to put his reliability or credibility as Bidder into question, **CTUIL** may disqualify the Bidder from the

tender process or terminate the contract, if already signed, for such reason.

- (2) If the Bidder/Contractor has **committed a transgression** through a violation of Section II such as to put his reliability or credibility into question, CTUIL may, after following due procedures, **ban /blacklist the Bidder/Contractor in line with CTUIL's policy for "Black-Listing of Firms / Banning of Business"**. The imposition and duration of the **ban** will be determined by the severity of the transgression. The severity will be determined by the circumstances of the case, in particular the number of transgressions, the position of the transgressors within the company hierarchy of the Bidder/Contractor and the amount of the damage. The **ban** will be **imposed for a maximum of 3 years**.
- (3) If the Bidder/Contractor can prove that he has restored/recouped the damage caused by him and has installed a suitable corruption prevention system, CTUIL may revoke the **ban** prematurely.

Section IV - Liability for violation of Integrity Pact

- (1) If CTUIL has disqualified the Bidder from the tender process prior to the award under Section III, **CTUIL is entitled for forfeiture of the Bid Guarantee under the Bid.**
- (2) If CTUIL has terminated the contract under Section III **or if CTUIL is entitled to terminate the contract under Section III, CTUIL shall be entitled to forfeit the Contract Performance Guarantee of this contract, in full or part thereof as may be decided,** besides resorting to other remedies under the contract.

Section V- Previous Transgression

- (1) The Bidder shall **disclose in its Bid any** transgressions occurred in the last 10 years with any other Public Sector Undertaking **or Government Department or any other Company, in any country, that may impinge on the Anti-corruption principle.**
- (2) If the Bidder makes incorrect statement on this subject, **it can be disqualified from the tender process or the contract, if already awarded, can be terminated for such reason and further action can be taken in line with CTUIL's policies.**

Section VI - Equal treatment to all Bidders /Contractors

- (1) **CTUIL will enter into agreements with identical conditions as this one with all Bidders.**
- (2) **CTUIL will disqualify from the tender process any bidder who does not sign this Pact or violate its provisions.**

Section VII - Punitive Action against violating Bidders/Contractors

If CTUIL obtains knowledge of conduct of a Bidder or a Contractor or **its** subcontractor or of an employee or a representative or an associate of a Bidder or Contractor or his Subcontractor which constitutes corruption, or if CTUIL has substantive suspicion in this regard, CTUIL will inform the Chief Vigilance Officer (CVO).

(*)Section VIII - Independent External Monitor/Monitors

- (1) **CTUIL/POWERGRID** has appointed a panel of Independent External Monitors (IEMs) for this Pact with the approval of Central Vigilance Commission (CVC), Government of India. **The names of the IEMs have been indicated in the Bidding Documents.**
- (2) The **panel of IEMs shall** review independently and objectively, whether and to what extent the parties comply with the obligations under this agreement. **The panel of IEMs** has right of access to all project documentation. **The panel of IEMs** may examine any complaint received by **them** and submit a report to Chairman-cum-Managing Director, **CTUIL/POWERGRID, giving joint findings**, at the earliest. **The panel** of IEMs may also submit a report directly to the CVO and the CVC, in case of suspicion of serious irregularities attracting the provisions of the PC Act.
- (3) The IEM is not subject to instructions by the representatives of the parties and performs his functions neutrally and independently. He / **She** reports to the Chairman-cum-Managing Director, **CTUIL/POWERGRID.**
- (4) The Bidder(s)/Contractor(s) accepts that the IEM has the right to access without restriction to all documentation of **CTUIL** related to this contract including that provided by the Contractor/Bidder. The Bidder/Contractor will also grant the IEM, upon his / **her** request and demonstration of a valid interest, unrestricted and unconditional access to **their** documentation. The same is applicable to Subcontractors. The IEM is under contractual obligation to treat the information and documents of the Bidder(s)/Contractor(s)/Subcontractor(s) with confidentiality.
- (5) **CTUIL** will provide to the IEMs information as sought by him / **her** which could have an impact on the contractual relations between **CTUIL** and the Bidder/Contractor related to this contract. **The IEMs shall also sign declaration on 'Non-Disclosure of Confidential Information' and of 'Absence of Conflict of Interest'. In case of any conflict of interest arising at a later date, the IEM shall inform Chairman-cum-Managing Director, CTUIL/POWERGRID and recuse himself/herself from that case**
- (6) As soon as the IEM notices, or believes to notice, a violation of this agreement, he / **she** will so inform the Chairman-cum-Managing Director,

CTUIL/POWERGRID and request the Chairman-cum-Managing Director, **CTUIL/POWERGRID** to discontinue or take corrective action, or to take other relevant action. The IEM can in this regard submit non-binding recommendations. Beyond this, the IEM has no right to demand from the parties that they act in a specific manner, refrain from action or tolerate action. However, the IEM shall give an opportunity to **CTUIL** and the Bidder/Contractor, as deemed fit, to present its case before making its recommendations to **CTUIL**.

- (7) The IEM will submit a written report to the Chairman-cum-Managing Director, **CTUIL/POWERGRID** within 8 to 10 weeks from the date of reference or intimation to him by **CTUIL/POWERGRID** and, should the occasion arise, submit proposals for correcting problematic situations.
 - (8) If the IEM has reported to the Chairman-cum-Managing Director, **CTUIL/POWERGRID**, a substantiated suspicion of an offence under **PC / IPC Act**, and the Chairman-cum-Managing Director, **CTUIL/POWERGRID** has not, within the reasonable time taken visible action to proceed against such offence or reported it to the CVO, the Monitor may also transmit this information directly to the CVC, Government of India.
 - (9) **While representing any matter in relation to the Integrity pact inter-alia including its transgression to the panel of IEMs, CTUIL/POWERGRID and Bidder/Contractor shall not approach the court of law and await the decision of the IEM in the matter.**
 - (10) The word '**IEM**' would include both singular and plural.
- (*) *This Section shall be applicable for only those packages wherein the IEMs have been identified in Section - I of the Bidding Documents.*

Section IX - Pact Duration

This Pact begins when both parties have legally signed it. It expires for the Contractor after the closure of the contract and for all other Bidder's six month after the contract has been awarded.

Section X - Other Provisions

- (1) This agreement is subject to Indian Law. Place of performance and jurisdiction is the establishment of **CTUIL**. The Arbitration/**conciliation** clause provided in the main tender document / contract shall not be applicable for any issue / dispute arising under Integrity Pact.
- (2) Changes and supplements as well as termination notices need to be made in writing. **Side agreements have not been made.**

- (3) If the Contractor is a partnership firm or a consortium or Joint Venture, this agreement must be signed by all partners, consortium members and Joint Venture partners.
 - (4) Nothing in this agreement shall affect the rights of the parties available under the General Conditions of Contract (GCC) and Special Conditions of Contract (SCC).
 - (5) **Issues like Warranty/Guarantees etc. shall be outside the purview of IEMs.**
 - (6) Views expressed or suggestions/submissions made by the parties and the recommendations of the CVO/IEM# in respect of the violation of this agreement, shall not be relied on or introduced as evidence in the arbitral/ **conciliation** or judicial proceedings (arising out of the arbitral/ **conciliation** proceedings) by the parties in connection with the disputes/differences arising out of the subject contract.
- # *CVO shall be applicable for packages wherein IEM are not identified in **Section - I of the Bidding Documents**. IEM shall be applicable for packages wherein IEM are identified in **Section - I of the Bidding Documents**.*
- (7) Should one or several provisions of this agreement turn out to be invalid, the remainder of this agreement remains valid. In this case, the parties will strive to come to an agreement to their original intentions.

(Signature) _____
(For & On behalf of CTUIL)

(Signature) _____
(For & On behalf of Bidder/ Partner(s) of Joint Venture/ Contractor)

(Office Seal)

(Office Seal)

Name: _____

Name: _____

Designation: _____

Designation: _____

Witness 1 : _____

Witness 1 : _____

(Name & Address) _____

(Name & Address) _____

Witness 2 : _____

(Name & Address) _____

Witness 2 : _____

(Name & Address) _____

(Declaration of Key Managerial Person (KMP) and Power of Attorney holder)

Bidder's Name and Address:

To:

Name :
Address :

C&M
Central Transmission Utility of India Limited
(A wholly owned subsidiary of POWERGRID)
10th floor, IRCON International Tower-1, Plot No. 16
Sector-32, Gurugram - 122001, Haryana

Dear Sir,

- 1.0 We confirm that the declarations made in our proposal, inter-alia including **Attachment-2 (Credentials towards Technical Evaluation Criteria)** regarding eligibility/qualification data and documents submitted in our proposal in support of the declarations, are true and correct to the best of our knowledge.
- 1.1 We are furnishing a declaration regarding nature of engagement of Key personnel as per the following details:

Sl. No.	Position	Name of Key Personnel	Nature of engagement of Key Personnel
1	Team Leader cum Project Manager		
2	Transmission Line Expert		
3	Substation Expert		
4	Field Engineer-I (Substation)		
5	Field Engineer-II (Substation)		
6	Field Engineer-I (Transmission Line)		
7	Field Engineer-II (Transmission Line)		

We further confirm that after award of contract, key personnel who are not employees of our firm, the hiring agreement between us and the key personnel shall be submitted to CTU within 15 days from the issue of GeM contract order.

- 2.0 We also confirm that in support of meeting the Qualification Requirements and Technical Evaluation Criteria as per RfP Documents, we have enclosed self-certified copy of documentary evidence in support of the above requirements.
- 3.0 We shall furnish clarification to proposal, if any sought by Employer pursuant to Section-III Clause 20.0. We understand that if we fail to rectify/furnish the requested documents if any, within 07 days' notice, our proposal is liable to be rejected.

- 4.0 We further confirm that we shall furnish a declaration as per format provided in Bidding Document regarding key personnel engagement for carrying out requisite activities under the contract along with monthly invoice. We also understand in absence of the declaration our invoice shall be considered as incomplete and may not be processed by employer.

- 5.0 We further confirm and certify that qualification and experience of Key Personnel brought out in "FORM-1_CV of Expert" and the details brought out in the Curriculum Vitae/Resume of identified key personnel including their professional Qualifications, Work experience, previous employment history etc. have been verified by us and have been found to be correct. We understand that any misrepresentation/factual error in these details shall lead to disqualification of our bids. Further, the Employer may take any action it may deem fit inter-alia including banning/backlisting in future contracts, forfeiture of bid security, Contract Performance Guarantee etc.

- 6.0 Notwithstanding above, we also confirm that the Employer may verify the supporting documents/ details in connection with above declarations. We further understand that in case of any unethical practices inter-alia including any misrepresentation of facts, submission of false and/or forged details/ documents/ declaration by us, we may be debarred from the participation in Employer's tenders in future as considered appropriate by Employer and our Contract Performance Guarantee shall be forfeited besides taking other actions as deemed appropriate.

Date:.....

Place:.....

(Signature of Power of Attorney holder).....

(Printed Name).....

(Designation).....

(Common Seal).....

(Signature of Key Managerial Person).....

(Printed Name).....

(Designation).....

(Common Seal).....

Note: Key Managerial Personnel (KMP) of the company shall include CEO/Managing Director/ Company Secretary/ Director/ CFO/any of the partner in case of partnership firm/any other

officer entrusted with substantial powers of the management of the affairs of the company/firm.

(Information regarding Ex-employees of CTUIL/POWERGRID in our Organization)

Bidder's Name and Address:

To:

Name :
Address :

C&M
Central Transmission Utility of India Limited
(A wholly owned subsidiary of POWERGRID)
10th floor, IRCON International Tower-1, Plot No. 16
Sector-32, Gurugram - 122001, Haryana

Dear Sir,

We declare that we are aware of and have gone through the "Code of Business Conduct and Ethics for Senior Management Personnel" and "Code of Business Conduct and Ethics for Board Members" of POWERGRID (hereinafter referred to as the "Code of Conduct"). We further understand that as per the "Code of Conduct", Senior Management Personnel including Board Members, who have retired/resigned from CTUIL/ POWERGRID, shall not accept any appointment or post, as detailed in the referred "Code of Conduct", within 1 year from the date of cessation of service/directorship unless approved by the Competent Authority.

Accordingly, we hereby furnish the details of ex-employees of CTUIL/ POWERGRID who had retired/resigned at the level of General Manager and above from CTUIL/ POWERGRID and subsequently have been employed by us:

Sl. No.	Name of the person with designation in CTUIL	Date of Retirement/resignation from CTUIL/ POWERGRID	Date of joining and designation in our organisation*
1			
2			
3			

Note: (*) In case the date of joining in the bidder's organisation of such ex-employee is within 1 year from the date of retirement/resignation from CTUIL/ POWERGRID, No Objection Certificate/approval from the Competent Authority must be furnished along with the bid or subsequent through clarification pursuant to clause 20.0 of section-III.

In case of non-submission of No Objection Certificate/approval from the Competent Authority, as required, we understand that CTUIL shall deal with such cases as per its policy and procedures of POWERGRID in vogue, which may also result in rejection of our bid. We also confirm that CTUIL shall be the sole judge in this regard.

We further declare that any misrepresentation or submission of false/forged documents/information in this regard shall be dealt with as per the provisions of the Integrity Pact and/or the Bidding Documents and/or POWERGRID's policy and procedures.

Date:

Name and Signature:

Place:

Designation:

Note:

1. "Code of Business Conduct and Ethics for Senior Management Personnel" and "Code of Business Conduct and Ethics for Board Members" are available on POWERGRID's website <https://www.powergrid.in/>.
2. In case bidder has furnished no details on ex-employees of CTUIL/POWERGRID or has left blank or has indicated '-' against the same, it shall be deemed that they have not employed any such person in their organization.

Curriculum Vitae (CV) of Expert

1. **Proposed Position** :
2. **Name of Expert** :
- 2a. **Adhaar Number** :
- 2b. **Contact Number** :
- 2c. **e-Mail ID** :
3. **Date of Birth** :
4. **Nationality** :
5. **Educational Qualification** :

(Starting with highest qualification, list the qualification)

Sl. No.	Year	Degree	College	Supporting Document attached as

6. **Employment Record** :

(Starting with present position, list in reverse order every position held with employer. Also mention the duration of position)

Sl. No.	Period From (DD-MM-YY) to (DD-MM-YY)	Position	Name of Employer	Supporting Document attached as
1.	(DD-MM-YY) to (DD-MM-YY)			
2.	(DD-MM-YY) to (DD-MM-YY)			
3.	(DD-MM-YY) to (DD-MM-YY)			
4.			
..			

7. **List of EHV Projects on which the Expert has worked** *(provided details shall be considered as experience of Expert as per the requirement of Cl. 1.2 of Annexure-I to Section-III):*

Sl. No.	Duration (From DD-MM-YY to DD-MM-YY)	Name of Project	Name of Client	Name of Employer	Description of responsibilities
1.	DD-MM-YY to DD-MM-YY				Worked as (position): Voltage Level: <u>Detail of works description/ responsibilities handled related to requirement of QR:</u>

				
2.	DD-MM-YY to DD-MM-YY				Worked as (position): Voltage Level: <u>Detail of works description/ responsibilities handled related to requirement of QR:</u>
3.	DD-MM-YY to DD-MM-YY				Worked as (position): Voltage Level: <u>Detail of works description/ responsibilities handled related to requirement of QR:</u>
4.				
...				
Total experience of EHV Transmission Projects: ... Years & Months.					

Note:

- i. While calculating "Total experience of EHV Transmission Projects", overlapping period shall not be considered.

Certification by Expert:

1. I, the undersigned, certify that to the best of my knowledge and belief, this CV correctly describes me, my qualifications and my experience.
2. I am willing to work on the Project and I will be available for Project assignment as per the requirement of Contract.
3. I confirm that I am not part of any under bidding and awarded IE packages of employer with any other bidder. I further confirm my exclusive association with <... .. *Name of the Bidder*... ..>.

(Signature and name of the Expert)

Place:

Date:

(Signature and name of the authorized signatory of the Bidder)

Seal of the firm

Notes:

1. Use separate form for each Expert.
2. Each page of the CV shall be signed in ink and dated by both the Expert concerned and by the authorized signatory of the Bidder firm along with the seal of the firm and upload the same as per requirement. However, Hard copy of the same CV shall be submitted by Successful Bidder within 15 days from the issuance of GeM Contract Order.
3. The self-attested copy of degree should be provided as Proof of Education Qualification.
4. Self-attested copy of Aadhar Card should be provided along with the CV.
5. In support of Employment record, the expert shall furnish self-attested copy(ies) of employment record (viz. joining letter, relieving letter, experience letter etc.) issued by previous employer(s).
6. Bidders are advised to submit CV in line with this format only for the subject package.

Certificate from Statutory Auditors/ Chartered Accountant regarding Professional fees

(Refer Clause 1.3 (a) of Annexure-I of Section-III)

Sl. No.	Financial Year	Professional Fee received (Rs. in Crores)
1.	2023-24	
2.	2022-23	
3.	2021-22	

This is to certify that (*name of the bidder*) has received the payments shown above against the respective financial years on account of professional fees for providing advisory or consultancy services to its clients. It is also certified that the amounts mentioned above does not include professional fees for undertaking dispute resolution proceeding before courts, tribunals or arbitrators.

Name of the Auditor Firm:

Name of the partner:

Membership Number:

UDIN:

Date:

**(Declaration regarding engagement of Experts)
(on company's letter head)**

Consultant's Name and Address: To:

Name : Engineer-in-Charge
Address : Central Transmission Utility of India Limited
(A wholly owned subsidiary of POWERGRID)
10th floor, IRCON International Tower-1, Plot No. 16
Sector-32, Gurugram - 122001, Haryana

Dear Sir,

1.0 With reference to GeM Contract Order dtd xx.xx.xxxx for(Package Name)....., we hereby confirm that following Experts have carried out the requisite activities under the contract and were involved in preparation of monthly report for the month, 2022:

Sl.no.	Experts	Name	Signature
1.	Project Manager cum Team Leader		
2.	Substation Expert		
3.	Transmission Line Expert		

2.0 We understand that any false declaration and/or misrepresentation of facts and/or furnishing of false information may lead to termination of Contract/our debarment from participation in Employer future tenders and that our Contract Performance Guarantee may be forfeited besides other actions as deemed to be appropriate as per the provisions of GeM Contract Order/Integrity Pact.

Date:

Authorised Signatory:

Place:

Designation:

(Declaration regarding Field Engineer (Transmission Line/Substation))
(on company's letter head)

Consultant's Name and Address: To:

Name : Engineer-in-Charge
Address : Central Transmission Utility of India Limited
 (A wholly owned subsidiary of POWERGRID)
 10th floor, IRCON International Tower-1, Plot No. 16
 Sector-32, Gurugram - 122001, Haryana

Dear Sir,

- 1.0 With reference to GeM Contract Order dtd xx.xx.xxxx for(Package Name)....., we hereby confirm that following Field Engineer (Transmission Line/Substation) is present at site and have carried out the requisite activities mentioned in ToR/RfP Document for preparation of report for the month 202X under the contract:

Experts	Name	Signature
Field Engineer (Transmission Line/ Substation)		

Further, we are also maintaining a database of attendance and we understand that employer may ask the database of attendance of expert as and when required.

- 2.0 We understand that any false declaration and/or misrepresentation of facts and/or furnishing of false information may lead to termination of Contract/our debarment from participation in Employer future tenders and that our Contract Performance Guarantee may be forfeited besides other actions as deemed to be appropriate as per the provisions of Contract Agreement/Integrity Pact.

Date:

Authorised Signatory:

Place:

Designation:

Note: Separate declaration form shall be furnished by bidder for substation and Transmission Line field engineer.

Appointment of Independent Engineer for “Transmission system for evacuation of power from Rajasthan REZ Ph-IV (Part- 3:6 GW) [Bikaner complex]: Part-B”.

Specification No.: [CTUIL/IE/2024-25/58](#)

Price Schedule

(This price schedule is for reference; however, bidder has to quote their total price (incl GST) on GeM portal only.) #

Name of The Bidder:

1. Remuneration for Key Personnel

Position	No. of Months	Rate/month (excl. GST)	Total Amount
Project Management Expert/Team Leader	22		
Substation Expert	22		
Transmission Line Expert	22		
Field Engineer- I (Substation)	22		
Field Engineer- II (Substation)	22		
Field Engineer- I (Transmission Line)	22		
Field Engineer- II (Transmission Line)	22		
Total			
GST Rate (in %)			
GST Value (In INR)			
Grand Total incl. GST			

The Man-Month rates for remuneration for Key Personnel quoted above are inclusive of all costs such as salary & allowances etc. for carrying out all activities as per ToR.

Cost to be incurred for carrying out scope of work as detailed in ToR towards support staff and Travel of Key Personnel to site/substation/CTUIL Office where work is to be carried out inclusive in the above rates.

Note: Lab charges for testing, revalidations from third parties (if required) shall be reimbursed by employer as per actual.

2. Reimbursable Expenditure for Key Personnel

Cost of Travel of Project Management expert (Team Leader)/ Substation expert /Transmission Line expert for witnessing the type tests/ FAT at manufacturers location whenever desired by the Employer. The travel/ accommodation expenses of the same shall be reimbursed as per the rates and terms given below:

- a) Per diem allowance towards Boarding & lodging, local travels and incidental expenses (Rate/ Day)

Cities	Rate/Day (in INR) excl. Taxes
Metro Cities – Delhi, Mumbai, Bangalore, Gurgaon, Hyderabad, Chennai & Kolkata	6,500/-
Principal Cities – Agra, Ahmedabad, Allahabad, Amritsar, Asansol, Bhopal, Coimbatore, Dhanbad, Faridabad, Indore, Jabalpur, Jaipur, Jamshedpur, Kanpur, Kochi, Lucknow, Ludhiana, Madurai, Meerut, Nagpur, Nasik, Patna, Pune, Rajkot, Surat, Vadodara, Varanasi, Vijayawada, Vishakhapatnam, state capitals.	5,300/-
Ordinary Cities	4,300/-

- b) Outstation Travel Expenses: Economy Class Airfare/Rail (upto 2nd class AC berth)/Road (Taxi- restricted to 2nd class AC Rail fare of equivalent distance). Consultant has to provide documentary evidence/receipt in support of the expenses.

#Note: 1. This price schedule is for reference, however bidder has to quote their total price (incl GST) on GeM portal only and price breakup (on letter head of the company) to be uploaded in line with price breakup field available on GeM portal.

2. Uploading price bid in any form in Technical Bid/Technical Cover will be at the bidder's risk and may result in rejection of its bid.